



INSTALLATION INSTRUCTIONS

GRILLE GUARD

2011-12 FORD EXPLORER

PART # 3065-2/ 3065

PARTS LIST:

1	Grille Guard	10	12mm Lock Washers
1	Driver/Left Frame Mounting Bracket	16	12mm x 32mm OD x 3mm Flat Washers
1	Passenger/Right Frame Mounting Bracket	8	12mm Hex Nuts
1	Driver/Left Side Top Support Bracket	2	10-1.50mm x 25mm Button Head Bolts
1	Passenger/Right Side Top Support Bracket	4	10mm x 20mm x 2mm Flat Washers
2	90mm x 50mm x 9mm Spacer Plates	2	10mm Nylon Lock Nuts
2	25mm x 20mm x 5mm Adhesive Backed Foam Pads	2	6mm x 35mm Hex Bolts
1	100mm x 50mm x 1.0mm Adhesive Backed Foam	2	6mm x 22mm x 2mm Flat Washers
2	12-1.75 x 35mm Bolt Plates	2	6mm Lock Washers
2	12-1.75mm Nut Plate	1	5mm x 25mm Screw
2	12-1.75mm x 50mm Hex Bolts	2	5mm x 10mm OD x 1mm Flat Washers
6	12-1.75mm x 35mm Hex Bolts	1	5mm Nylon Lock Nut

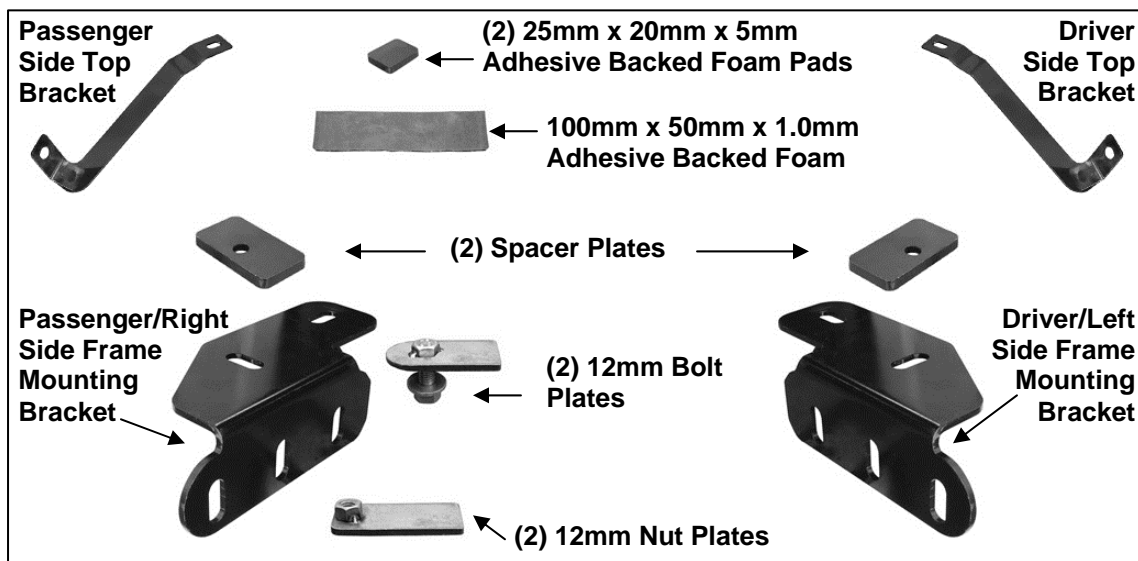

PROCEDURE:

1. REMOVE CONTENTS FROM BOX. VERIFY ALL PARTS ARE PRESENT. READ INSTRUCTIONS CAREFULLY BEFORE STARTING INSTALLATION. ASSISTANCE IS HIGHLY RECOMMENDED. CUTTING IS REQUIRED. DRILLING IS OPTIONAL.
2. Start installation under the driver side front of the vehicle, **(Figure 1)**. Insert (1) 12mm Nut Plate into the large oval opening in the bottom of the frame channel. Slide it forward in the frame with the flat side down-welded nut up, **(Figure 2C)**. Line up the threaded hole in the Nut Plate with the factory hole at the front of the frame, **(Figure 2A)**. Next, insert (1) 12mm Bolt Plate into the large oval opening and center the threaded bolt in the oval hole, **(Figure 2B)**.
3. Select the driver side Frame Mounting Bracket. Hold the Mounting Bracket up in position against the bottom of the frame and over the threaded bolt on the Bolt Plate, **(Figure 3A)**. Secure the Bracket to the Bolt Plate with (1) 12mm Flat Washer, (1) 12mm Lock Washer and (1) 12mm Hex Nut. Leave hardware loose at this time. Slide (1) Spacer Plate between the frame channel and the Bracket, **(Figure 3A & 3B)**. Insert (1) 12-1.75mm x 50mm Long Hex Bolt with (1) 12mm Lock Washer and (1) 12mm Flat Washer through the hole in the Bracket, Spacer Plate and into the Nut Plate, **(Figure 4)**. Snug but do not tighten hardware at this time.
4. Move to the passenger side of the vehicle. Determine if the vehicle is equipped with the factory installed fresh air inlet in the plastic bumper cover.
 - a. **Vehicles without air inlet:** Repeat **Steps 2 & 3** for passenger side Frame Mounting Bracket installation, **(Figures 5A, 5B & 5C)**.

- b. **Vehicles equipped with air inlet, (Figure 6):** Repeat **Step 2** to install the 12mm Bolt Plate and 12mm Nut Plate. Hold the Frame Bracket in the approximate position over the Bolt and Nut Plates. Mark the outline of the Bracket onto the mounting tab on the plastic air inlet, (scoop), **(Figure 7)**. Remove the inlet and place it on a clean, stable work surface. Use a hacksaw to cut the required material from the mounting area on the inlet. Check the fit often and trim material away as necessary. Do not cut off the mounting tab. Carefully pry off the metal clip and move it as indicated in **Figure 7** or drill a 1/4" hole through the top and bottom of the scoop and replace the clip with the included (1) 5mm x 25mm Screw, (2) 5mm Flat Washers and (1) 5mm Nylon Lock Nut. Do not over-tighten 5mm hardware. **IMPORTANT!** Any cutting tool may break or shatter. Government regulations require safety glasses & equipment at all times when cutting. Install the Frame Bracket as described in **Step 3**. **NOTE:** Complete the Grille Guard installation before reinstalling the plastic air inlet scoop, **(Step 15)**.

NOTE: Before proceeding, it may be considerably easier to remove the plastic bumper cover to cut the slots for the Grille Guard. However, the bumper cover may be held in place with rivets making removal and reinstallation very difficult, **(Figure 6)**. Determine if the bumper is held in place with rivets, (visible from the outside-below the fog lights), before attempting to remove the bumper cover.

5. Measure the width across the Grille Guard, (mounting tab to mounting tab-appx. 37" to 37-1/2"). Use a tape measure to locate the middle of the plastic bumper cover, **(Figure 8)**. Mark the mid point on the back of the bumper. **NOTE:** You can also locate the mold mark on the back of the bumper to determine the mid point. Place a layer of masking tape on the back of the bumper cover in front of the Frame Mounting Brackets. On the driver side, draw a vertical line on the tape 18-1/2" out from the middle of the bumper cover to the driver side. Draw a second vertical line 19-1/2" out from the middle, **(Figure 8)**.
6. Use the locations of the previously installed Frame Mounting Brackets to determine where to draw the top and bottom horizontal lines, **(Figure 9)**. Carefully cut this area out of the bumper cover with a sharp knife or hacksaw, **(Figure 10)**. **IMPORTANT:** Do not cut through the top or bottom edge of the bumper cover. Only remove enough material to clear the mounting tabs on the Grille Guard.
7. Repeat **Steps 5 & 6** to cut out the passenger side of the bumper cover.
8. Reinstall the bumper cover if previously removed.
9. With assistance, position the Grille Guard onto the outside of the Mounting Brackets. Attach the Grille Guard to the Mounting Brackets with (6) 12mm x 35mm Hex Bolts, (12) 12mm Flat Washers and (6) 12mm Nylon Lock Nuts, **(Figure 11)**. Align, level and adjust the Grille Guard but do not completely tighten the hardware at this time.
10. Open the front hood. Cover the top of the grille and plastic cover, (driver and passenger sides), with removable tape, (masking tape preferred-tape not included), to avoid damage to finish during Top Bracket installation, **(Figure 12)**. Select the driver side Top Bracket. Hold the Top Bracket in approximate position between the Grille Guard and the hex bolt on the top cover. Mark the location onto the tape on the plastic cover, **(Figure 13)**. Repeat this Step for passenger side Top Bracket.
11. Remove the cover. Note the type and location of all factory hardware for reinstallation.
12. Next, place a 2" x 2" piece of the Thin Adhesive Backed Foam Tape on the underside of the Top Brackets anywhere it can come in contact with the top of the plastic grille, **(Figure 14)**. Trim the Foam Tape as necessary.
13. Cut out the front edge of the cover and the front side of the indented pocket for the hex bolt, **(Figures 15 & 16)**, to clear the Top Brackets. Once properly trimmed, place the cover in the original position.
14. Insert the driver side Top Bracket through the opening cut into the top cover and line up the mounting slot. Bolt the Top Bracket to the cover with the included (1) 6mm x 35mm Hex Bolt, (1) 6mm Flat Washer and (1) 6mm Lock Washer, **(Figure 17)**. Line up the remaining, (forward), end of the Top Bracket with the hole in the upright on the Grille Guard. Bolt the Bracket to the inside of the upright with (1) 10mm x 25mm Button Head Bolt, (2) 10mm x 20mm Flat Washers and (1) 10mm Nylon Lock Nut, **(Figure 18)**. Repeat this Step for passenger side Top Bracket installation.
15. Align and adjust the Grille Guard properly and tighten all hardware. Remove protective masking tape from the top of the plastic grille, **(Step 9)**.
16. Reinstall the air inlet, (scoop), removed in **Step 4b**. Trim scoop to clear Brackets as necessary.
17. Do periodic inspections to the installation to make sure that all hardware is secure and tight.

To protect your investment, wax this product after installing. Regular waxing is recommended to add a protective layer over the finish. Do not use any type of polish or wax that may contain abrasives that could damage the finish.

For stainless steel: Aluminum polish may be used to polish small scratches and scuffs on the finish. Mild soap may be used also to clean the Grille Guard.

For gloss black finishes: Mild soap may be used to clean the Grille Guard.

Driver Side installation Pictured

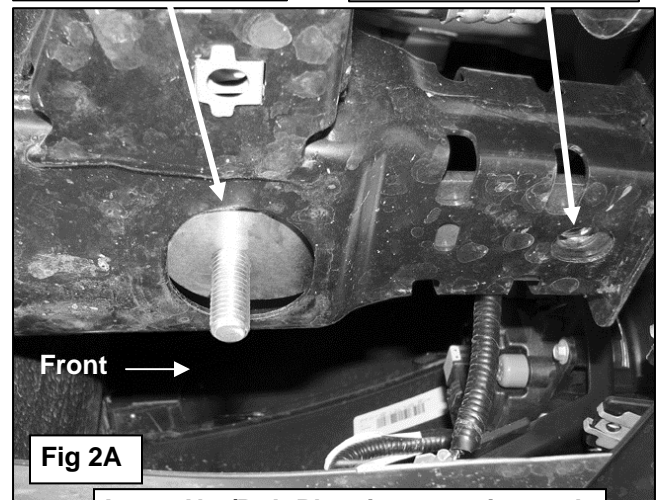
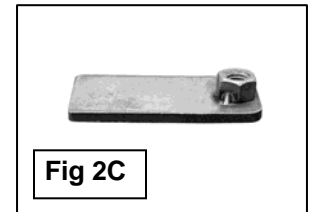
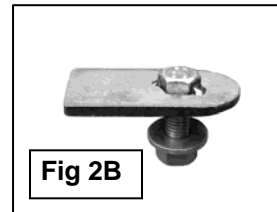
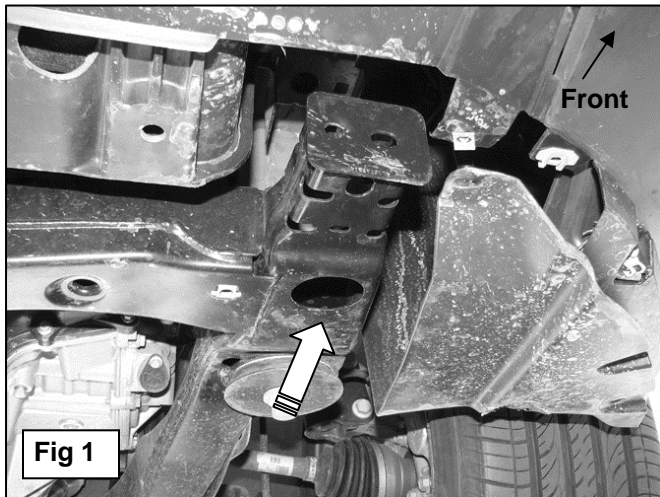

Insert Nut/Bolt Plate into opening and line up with hole in frame

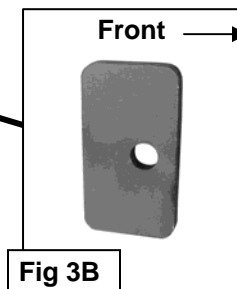
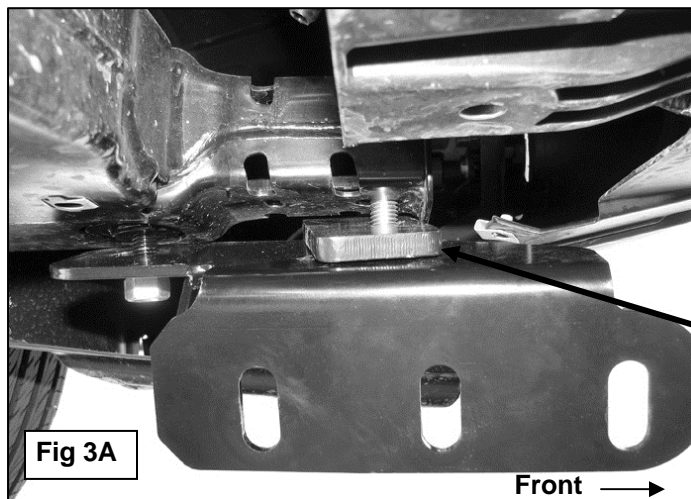

Driver Side Installation Pictured

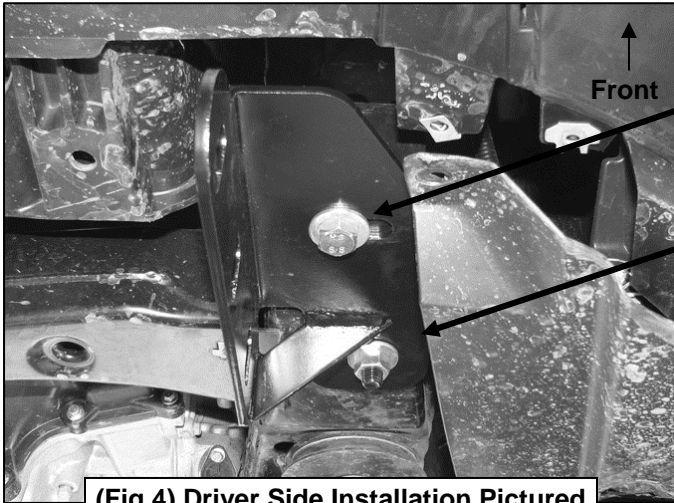

12mm x 50mm Hex Bolt
12mm Lock Washer
12mm Flat Washer

12mm Lock Washer
12mm Flat Washer
12mm Hex Nut

(Fig 4) Driver Side Installation Pictured

Passenger Side Installation Pictured

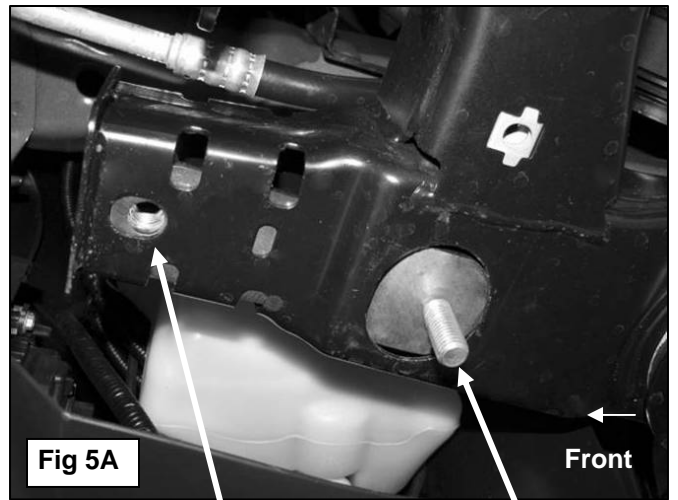

Fig 5A

Front

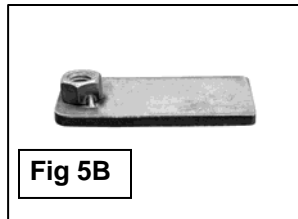

Fig 5B

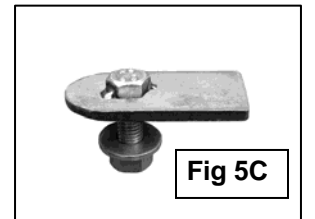
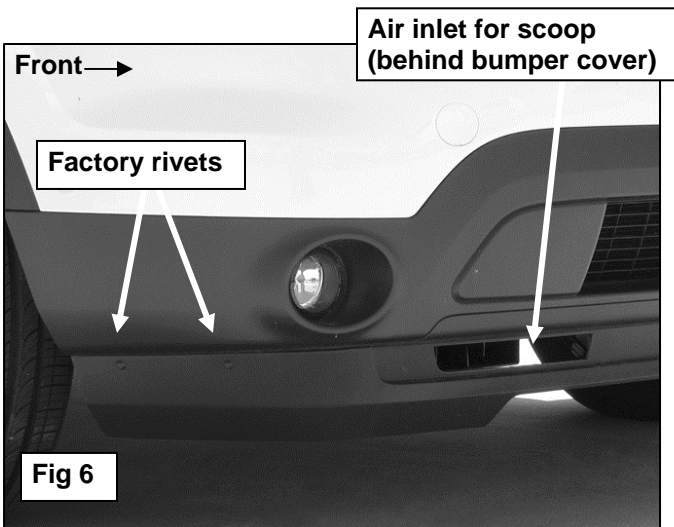

Fig 5C



Front →

Air inlet for scoop
(behind bumper cover)

Factory rivets

Fig 6

Illustrations, diagrams and measurements provided for example only. It is the installer's responsibility to determine exact cuts/modifications to the vehicle required for proper installation.

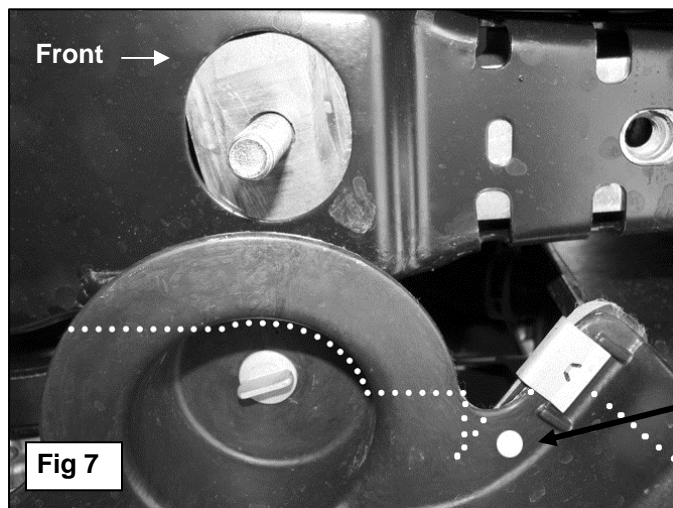
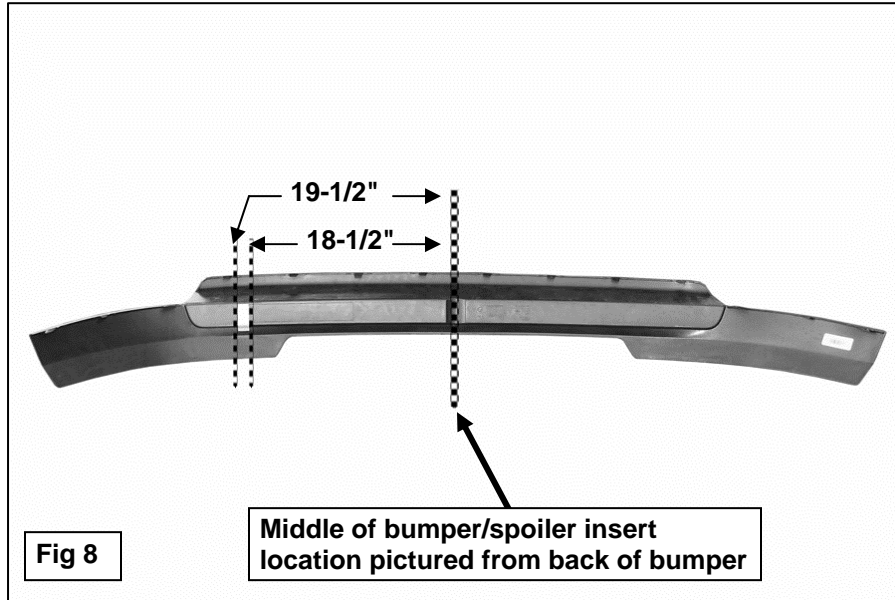

Fig 7

Front →

Move metal clip to here (Dot) or drill a 1/4" hole and replace the clip with the included:
(1) 5mm x 25mm Screw
(2) 5mm Flat Washers
(1) 5mm Nylon Lock Nut

Driver Side Installation Pictured



Draw lines to represent the top and the bottom of the Frame Bracket

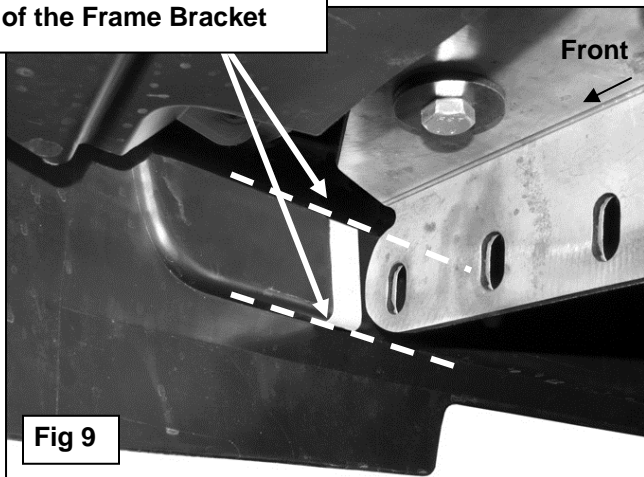

Illustrations, diagrams and measurements provided for example only. It is the installer's responsibility to determine exact cuts/modifications to the vehicle required for proper installation.

Cut as little as possible to clear brackets. Do not cut through the top or bottom edge of splash guard

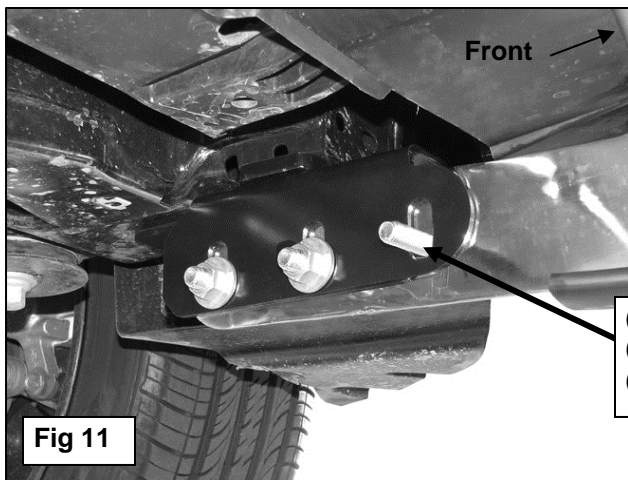
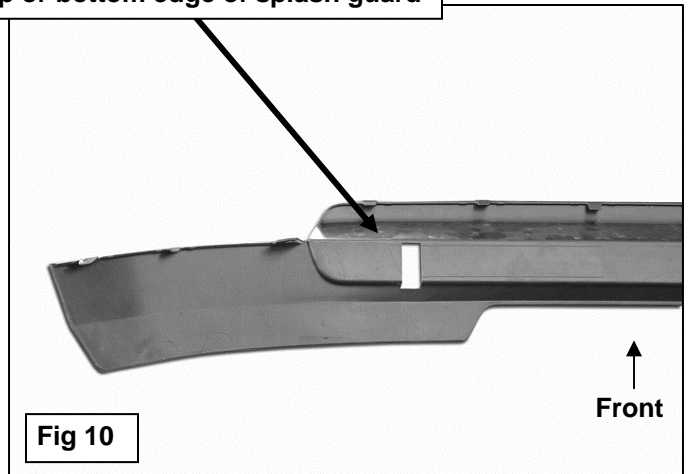

- (3) 12mm x 35mm Hex Bolts
- (6) 12mm Flat Washers
- (3) 12mm Nylon Lock Nuts

Driver Side Installation Pictured

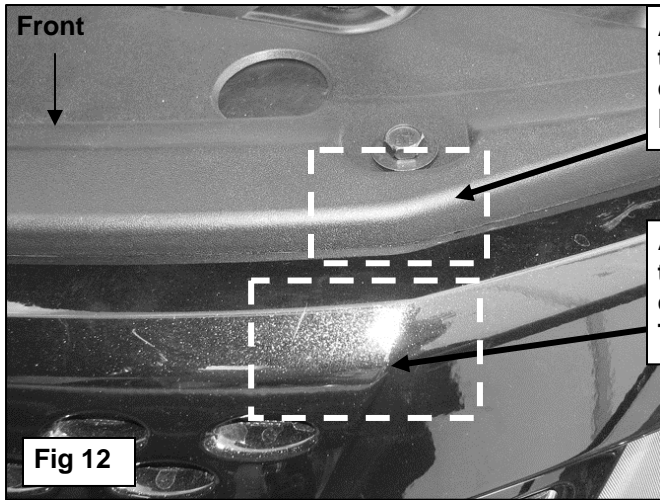

Apply a layer of removable tape to this area to mark (or mark back of cover) before cutting for Top Bracket installation (Fig 15 & 16)

Apply a layer of removable tape to this area to prevent damage to the finish during Top Bracket installation

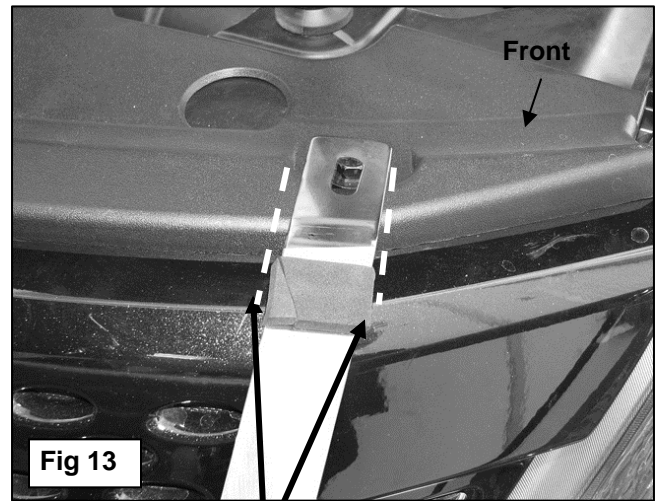

Place Top Bracket in mounting position. Mark removable tape on plastic cover as required to clear Top Bracket

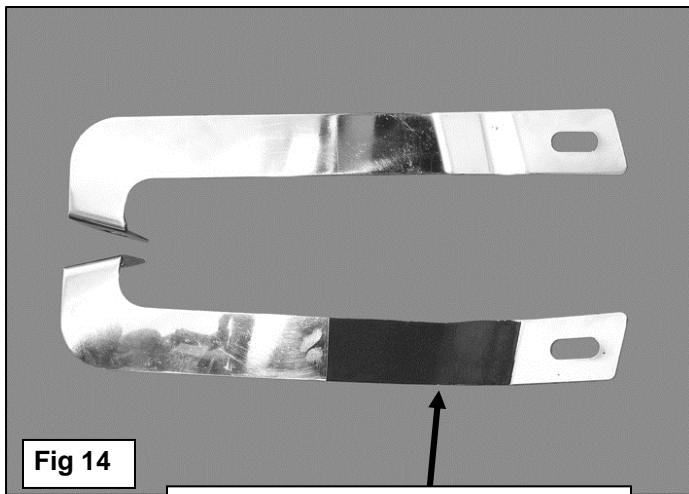

Apply 2" piece of thin Adhesive Backed Foam Tape to this area on the BOTTOM of both Top Brackets to prevent damage to the finish during Top Bracket installation. Trim tape to fit properly

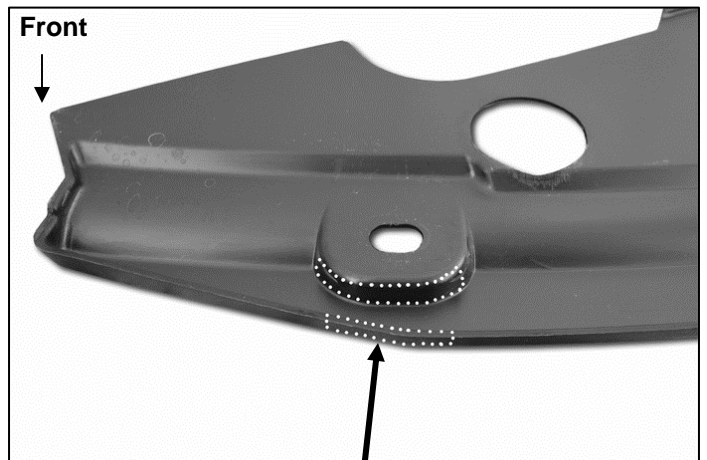

(Fig 15) Driver side-bottom of plastic cover pictured. Cut out area as indicated by dotted line

Driver Side Installation Pictured

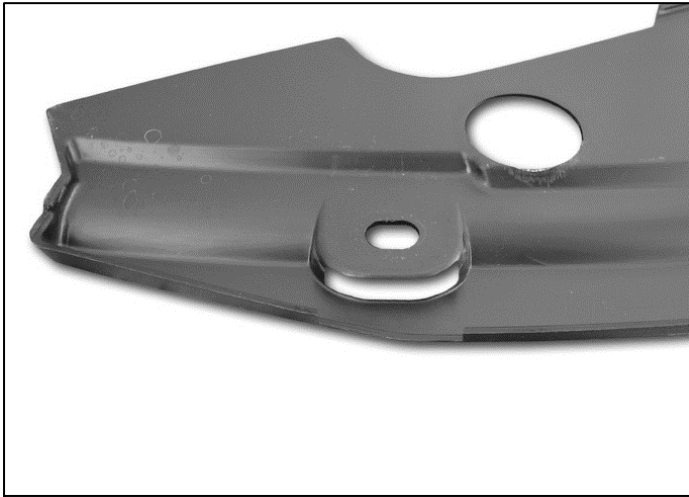

(Fig 16) Driver side-bottom of plastic cover pictured

Illustrations, diagrams and measurements provided for example only. It is the installer's responsibility to determine exact cuts/modifications to the vehicle required for proper installation.

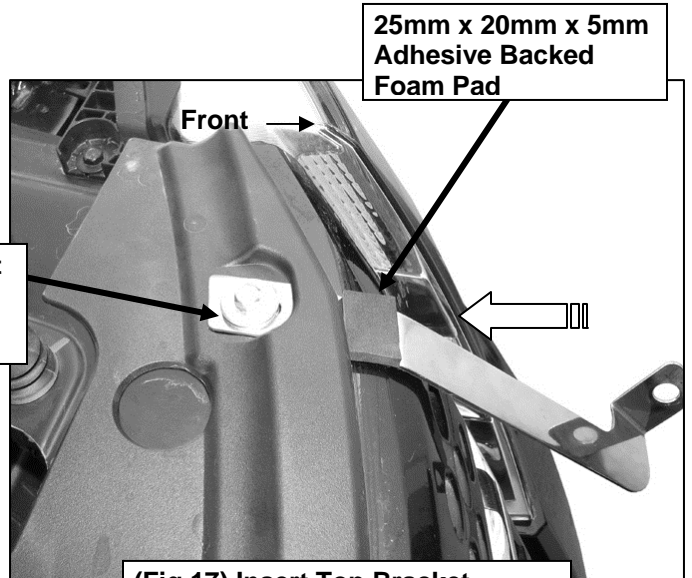

25mm x 20mm x 5mm
Adhesive Backed
Foam Pad

6mm x 35mm Hex Bolt
6mm Lock Washer
6mm Flat Washer

(Fig 17) Insert Top Bracket
through opening in plastic cover



Fig 18

10mm x 25mm Button
Head Bolt
(2) 10mm Flat Washers
10mm Nylon Lock Nut

