

# **Load****LIFTER** 5000™

## **ULTIMATE**

ADJUSTABLE AIR HELPER SPRINGS



Kit Number  
**88257**

### INSTALLATION GUIDE

For maximum effectiveness and safety, please read these instructions completely before proceeding with installation.

*Failure to read these instructions can result in an incorrect installation.*

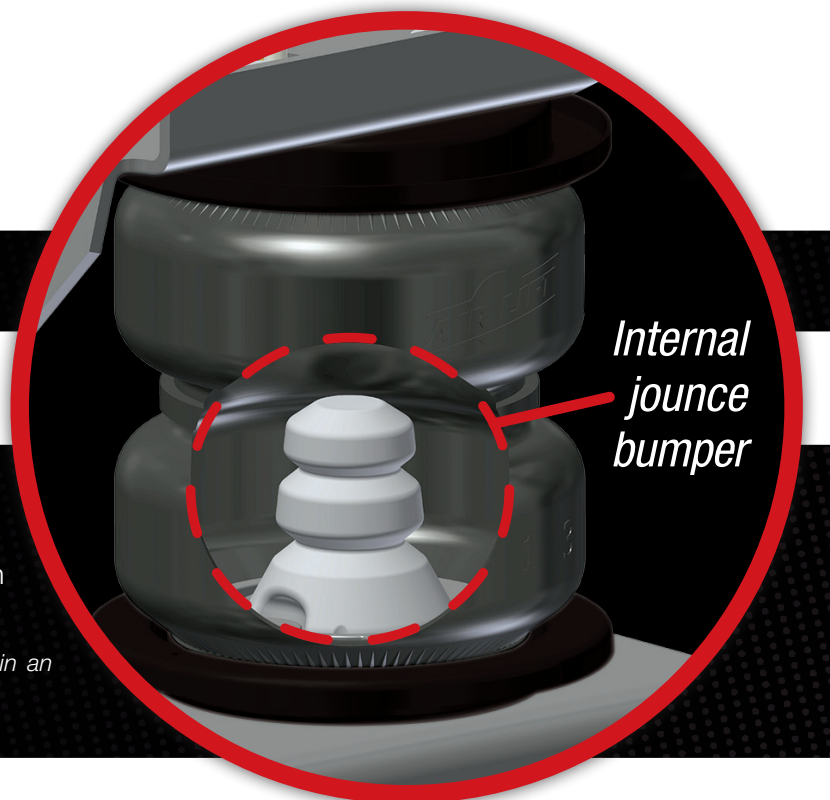



# TABLE OF CONTENTS

|   |           |
|---|-----------|
| <b>Installation Diagrams</b> .....                          | <b>2</b>  |
| <b>Hardware List and Tools List</b> .....                   | <b>3</b>  |
| Hardware List .....   | 3         |
| Tools List .....  | 3         |
| <b>Introduction</b> .....                                   | <b>4</b>  |
| Important Safety Notice .....                               | 4         |
| Notation Explanation .....                                  | 4         |
| <b>Installing the LoadLifter 5000 Ultimate System</b> ..... | <b>5</b>  |
| Getting Started .....                                       | 5         |
| Tech Tip Option .....                                       | 6         |
| Assembling the Air Spring Assemblies .....                  | 7         |
| Attaching the Upper Brackets .....                          | 9         |
| Attaching the Lower Brackets .....                          | 9         |
| <b>Installing the Air Lines</b> .....                       | <b>11</b> |
| Tips for Installing Air Lines .....                         | 12        |
| Installing the Heat Shield .....                            | 12        |
| <b>Finished Installation Photos</b> .....                   | <b>14</b> |
| <b>Before Operating</b> .....                               | <b>15</b> |
| Checking for Leaks .....                                    | 15        |
| Fixing Leaks .....  | 15        |
| Installation Checklist .....                                | 16        |
| Post-Installation Checklist .....                           | 16        |
| <b>Product Use, Maintenance and Servicing</b> .....         | <b>17</b> |
| Minimum and Maximum Pressure .....                          | 17        |
| Maintenance Guidelines .....                                | 17        |
| Tuning the Air Pressure .....                               | 18        |
| Guidelines for Adding Air .....                             | 18        |
| <b>Troubleshooting Guide</b> .....                          | <b>19</b> |
| Frequently Asked Questions .....                            | 19        |
| <b>Limited Warranty and Returns Policy</b> .....            | <b>21</b> |
| <b>Replacement Part Information</b> .....                   | <b>21</b> |
| <b>Contact Information</b> .....                            | <b>21</b> |

# Installation Diagram

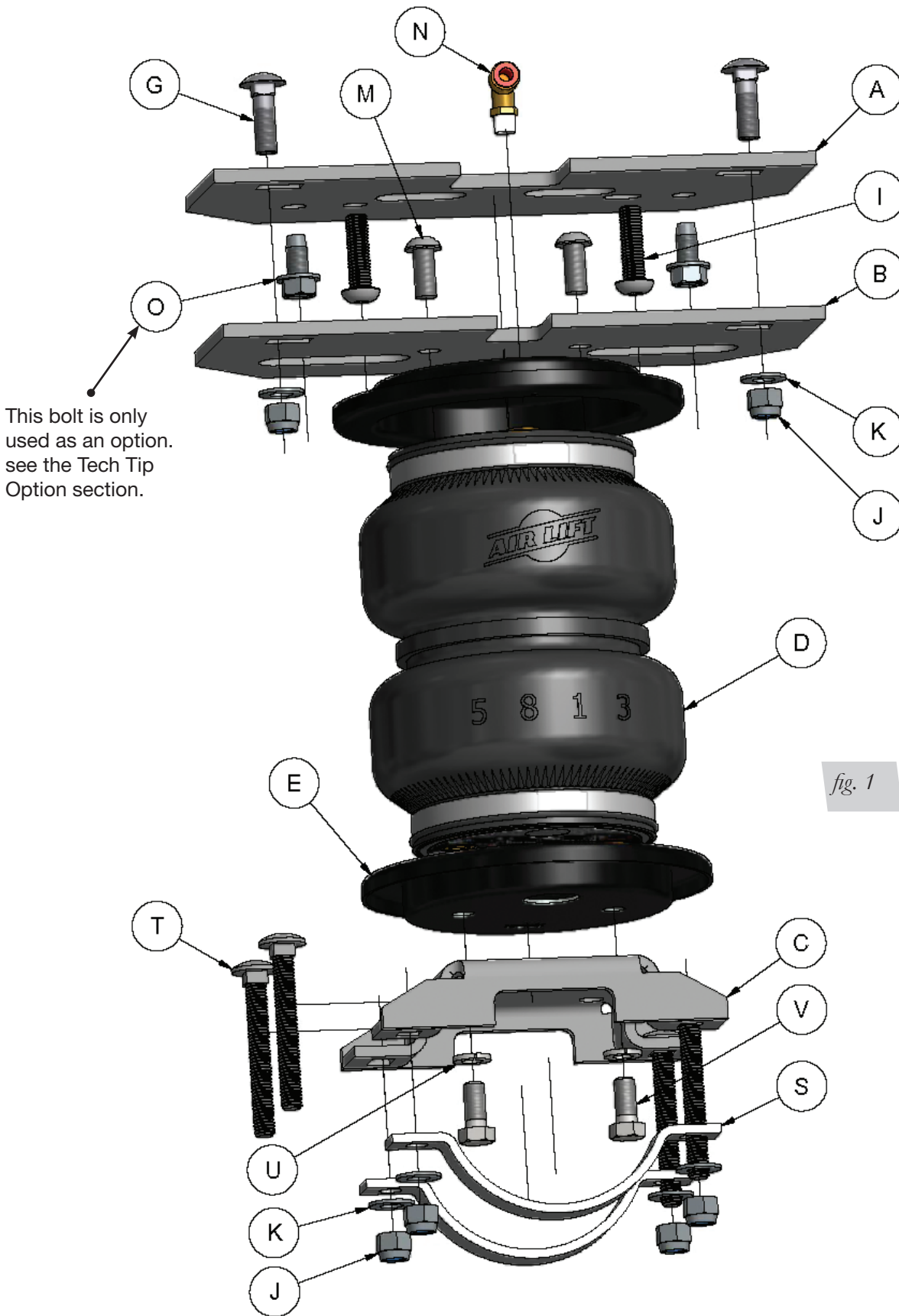

# Hardware and Tools Lists

## HARDWARE LIST

| Item | Part # | Description.....                      | QTY |
|------|--------|---------------------------------------|-----|
| A    | 07057  | Upper frame bracket .....             | 2   |
| B    | 07058  | Upper bellows bracket .....           | 2   |
| C    | 03230  | Lower bracket .....                   | 2   |
| D    | 58496  | Bellows .....                         | 2   |
| E    | 11967  | Roll plate .....                      | 4   |
| G    | 17361  | 3/8"-16 x 1 1/4" Carriage bolt .....  | 4   |
| I    | 17366  | M10-1.5 x 35 Button head screw .....  | 4   |
| J    | 18435  | 3/8" Nylon lock nut.....              | 12  |
| K    | 18444  | 3/8" Flat washer .....                | 12  |
| M    | 17365  | 3/8"-24 x 7/8" Button head screw..... | 4   |
| N    | 21837  | 90° Swivel fitting.....               | 2   |
| O    | 17151  | 3/8" x 3/4" Self tapping bolt.....    | 4   |
| S    | 10451  | Axle strap .....                      | 4   |
| T    | 17277  | 3/8"-16 x 3" Carriage bolt .....      | 8   |
| U    | 18427  | 3/8" Lock washer .....                | 4   |
| V    | 17203  | 3/8"-12 x 7/8" Hex bolt .....         | 4   |
| W    | 33107  | Heat shield kit.....                  | 1   |
| AA   | 20086  | Air line assembly .....               | 1   |
| BB   | 10466  | Tie straps.....                       | 6   |
| CC   | 21230  | Valve cap .....                       | 2   |
| DD   | 18501  | 5/16" Flat washer .....               | 2   |
| EE   | 21234  | Rubber washer .....                   | 2   |
| FF   | 18411  | Star washer .....                     | 2   |
| GG   | 21233  | 5/16" Hex nut .....                   | 4   |

## TOOLS LIST

| Description.....                                   | QTY |
|--|-----|
| Hoist or floor jacks .....                         | 1   |
| Safety stands.....                                 | 2   |
| Safety glasses .....                               | 1   |
| Torque wrench.....                                 | 1   |
| Standard open-end combo wrenches.....              | 1   |
| Ratchet.....                                       | 1   |
| Metric and Standard sockets .....                  | 1   |
| #6 Metric Allen wrench (socket if available) ..... | 1   |
| 7/32 Allen wrench (socket if available) .....      | 1   |
| 5/16" Drill bit (very sharp).....                  | 1   |
| Heavy duty drill.....                              | 1   |
| Hose cutter, razor blade or sharp knife .....      | 1   |
| Air compressor or compressed air source .....      | 1   |
| Spray bottle with dish soap/water solution.....    | 1   |

# Introduction

The purpose of this publication is to assist with the installation, maintenance and troubleshooting of the LoadLifter 5000 Ultimate air spring kit. LoadLifter 5000 Ultimate utilizes sturdy, reinforced, commercial grade single or double, depending on the kit, convolute bellows. The bellows are manufactured like a tire with layers of rubber and cords that control growth. LoadLifter 5000 Ultimate kits are recommended for most 3/4- and 1-ton pickups and SUVs with leaf springs and provide up to 5,000 pounds of load-leveling support with air adjustability from 5-100 PSI. The kits are also used in motor home rear applications and various front applications where leaf springs are used.

It is important to read and understand the entire installation guide before beginning installation or performing any maintenance, service or repair. The information here includes a hardware list, tool list, step-by-step installation information, maintenance guidelines and operating tips.

Air Lift Company reserves the right to make changes and improvements to its products and publications at any time. For the latest version of this manual, contact Air Lift Company at **(800) 248-0892** or visit **[airliftcompany.com](http://airliftcompany.com)**.

## IMPORTANT SAFETY NOTICE

The installation of this kit does not alter the gross vehicle weight rating (GVWR) or payload of the vehicle. Check your vehicle's owner's manual and do not exceed the maximum load listed for your vehicle.

**Gross vehicle weight rating:** The maximum allowable weight of the fully loaded vehicle (including passengers and cargo). This number — along with other weight limits, as well as tire, rim size and inflation pressure data — is shown on the vehicle's Safety Compliance Certification Label.

**Payload:** The combined, maximum allowable weight of cargo and passengers that the truck is designed to carry. Payload is GVWR minus the base curb weight.

## NOTATION EXPLANATION

Hazard notations appear in various locations in this publication. Information which is highlighted by one of these notations must be observed to help minimize risk of personal injury or possible improper installation which may render the vehicle unsafe. Notes are used to help emphasize areas of procedural importance and provide helpful suggestions. The following definitions explain the use of these notations as they appear throughout this guide.



### DANGER

INDICATES IMMEDIATE HAZARDS WHICH WILL RESULT IN SEVERE PERSONAL INJURY OR DEATH.



### WARNING

INDICATES HAZARDS OR UNSAFE PRACTICES WHICH COULD RESULT IN SEVERE PERSONAL INJURY OR DEATH.



### CAUTION

INDICATES HAZARDS OR UNSAFE PRACTICES WHICH COULD RESULT IN DAMAGE TO THE MACHINE OR MINOR PERSONAL INJURY.

---

## NOTE

*Indicates a procedure, practice or hint which is important to highlight.*

---

# Installing the LoadLifter 5000 Ultimate System

## GETTING STARTED

1. Raise the vehicle and support the axle with jack stands, setting the jack stands as wide as possible on the axle (fig. 2)

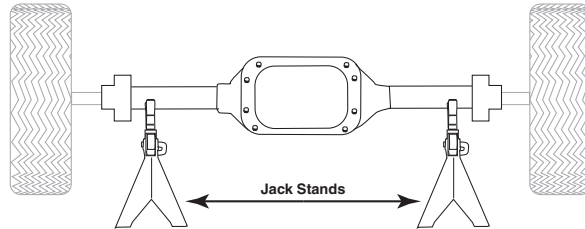

fig. 2

2. Drop the axle or raise the frame up to make room for the assemblies to be put into position between the frame and axle.
3. Remove the jounce bumper from under the frame rail (fig. 3).

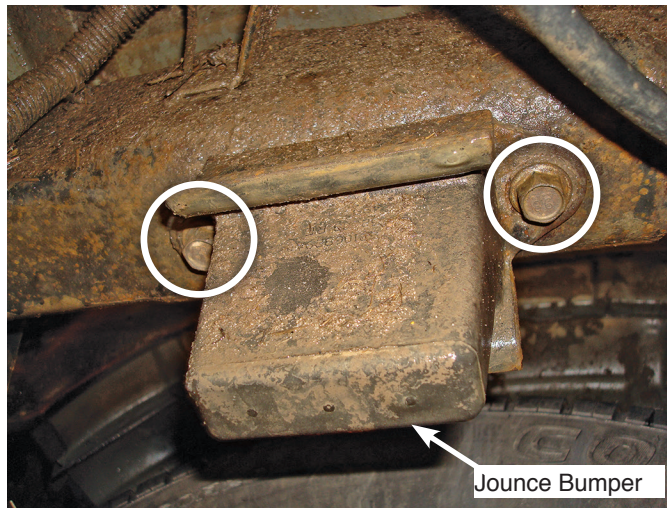

fig. 3

4. Attach the upper frame bracket (A) to the frame using the two M10-1.5 X 35 button head screws (I). Torque to 30 lb.-ft.

### NOTE

*The slot in the frame goes inboard towards the inside of the vehicle (fig. 4). Repeat for the opposite side.*

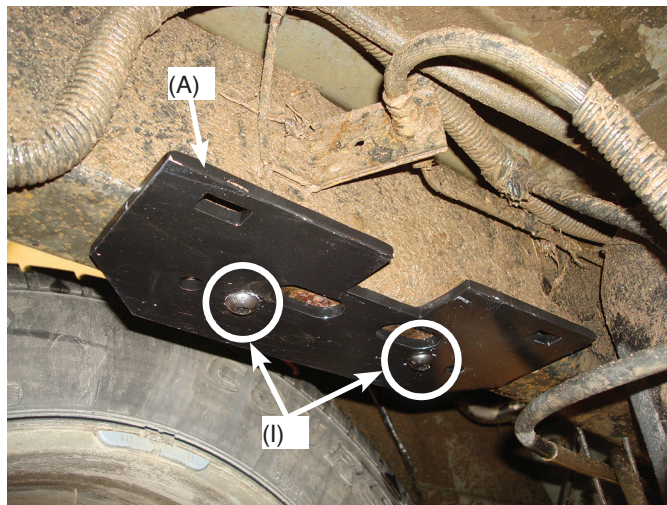

fig. 4

## TECH TIP OPTION

If by chance one of the jounce bumper bolts broke upon removal, bolt the bracket to the frame as noted above using the Jounce Bumper mounting hole the other bolt was removed from, to align the bracket.

1. Line up the hole in the upper bracket over the broken bolt (as if being bolted as stated above).
2. Center punch and drill a 5/16" hole in the center of the outside hole next to the broken bolt hole (fig. 5).

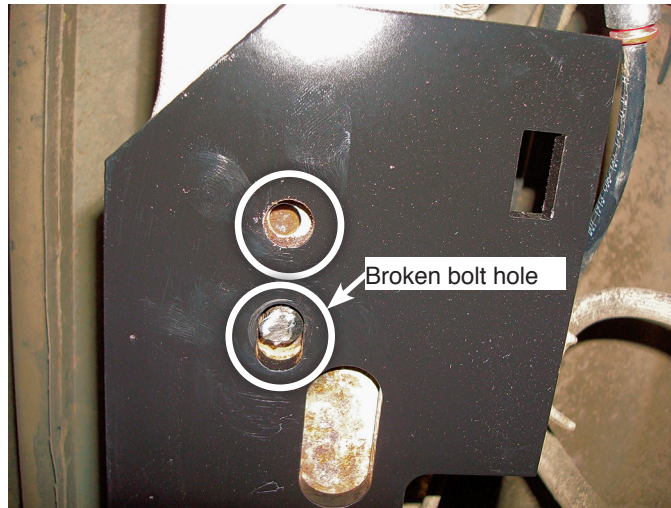

fig. 5

3. Insert and tighten a self-tapping bolt (O) into the hole drilled. Torque the bolt to 15 lb.-ft (fig. 6).

### NOTE

Figure 6 shows the upper bracket installed to the frame using the supplied M10 bolt (I) that was removed and a self-tapping bolt. **Use these only if the existing jounce bumper bolts break!**

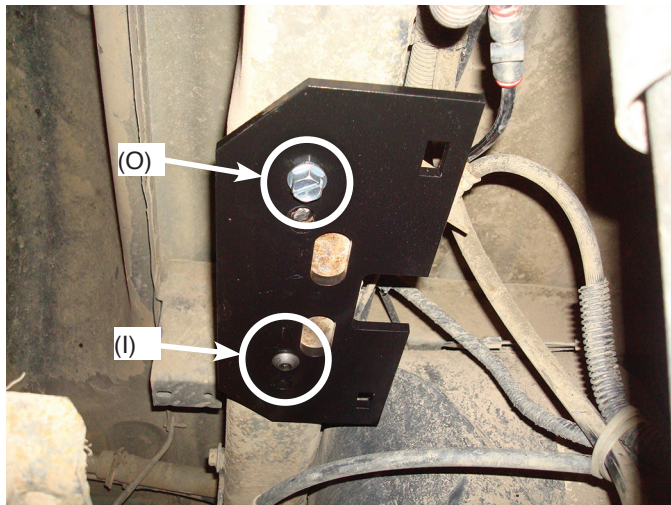

fig. 6



## ASSEMBLING THE AIR SPRING ASSEMBLIES

1. Set a roll plate (E) over the top of each air spring (D).

### NOTE

*The radiused (rounded) edge of the roll plate (E) will be towards the bellows so that the bellows is seated inside both roll plates.*

2. Install the Swivel Fitting (N) into the top of the Air Spring finger tight plus one and a half turns (fig. 7).

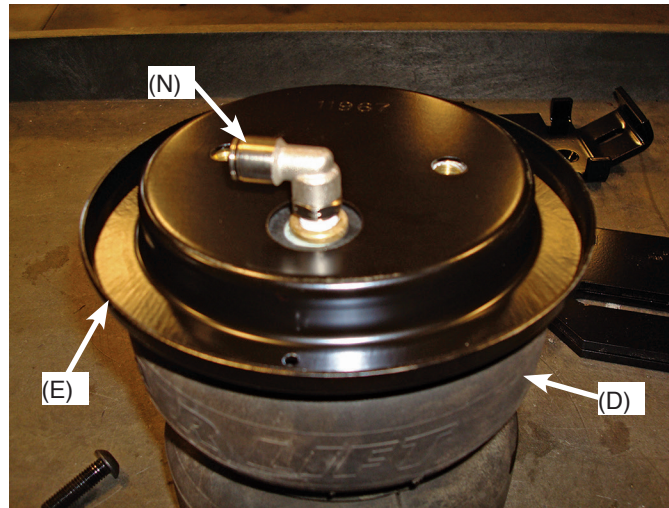

fig. 7

3. Install the Air Spring bracket (B) onto the Air Spring and attach using the 3/8 -24 X 7/8" Button Head Screws (M) (fig. 8). Torque to no more than 20 lb.-ft.



fig. 8

4. Repeat for the other assembly.

1. Flip the assemblies over; set a Roll Plate (E) onto the bottom of the Air Spring assembly (fig. 9).
2. Insert two 3/8-16 X 3.0" Carriage Bolts (T) into the lower bracket as shown and set the Lower Bracket (C) using holes "A" (fig. 10) so that the lower bracket is offset from the fitting (on the opposite (top) end of the assembly) (fig. 9). Attach the lower bracket with 3/8 Lock Washers (U) and two 3/8-24 X 3/4" Hex Bolts (V). Torque to no more than 20 lb.-ft.

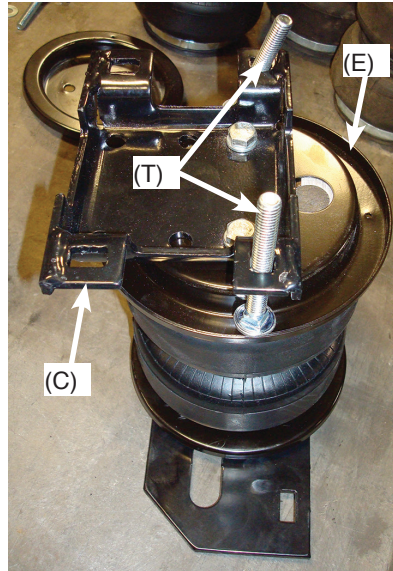

*fig. 9*

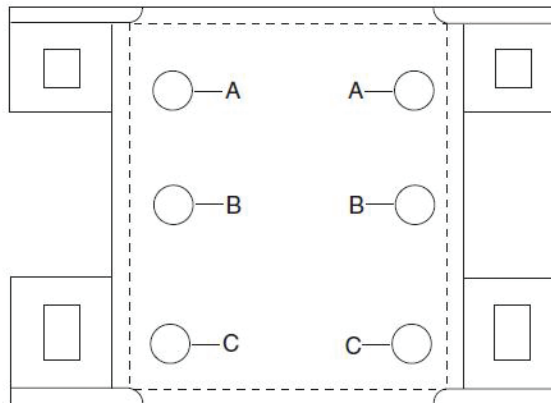

*fig. 10*

3. Figure 11 shows the finished assemblies.



*fig. 11*

## ATTACHING THE UPPER BRACKETS

1. Set the assemblies onto the axle with the fittings to the inside of the frame (fig. 12). Align the upper Air Spring and Frame bracket (A) (that was previously installed) slots and attach using two 3/8-16 X 1.25" Carriage Bolts (G), two Flat Washers (K) and two Nylon Lock Nuts (J). Repeat for the opposite side and leave hardware loose at this time.

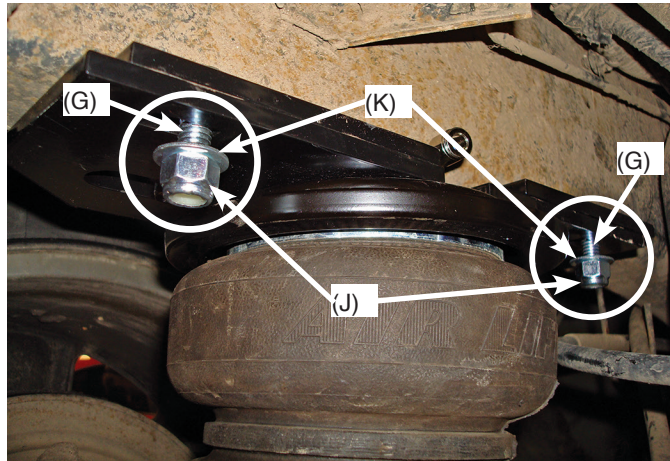

*fig. 12*

## ATTACHING THE LOWER BRACKETS

1. Raise the axle or lower the frame until the lower brackets touch the axle (figs.13 & 14).

**CAUTION**

MAKE SURE THE CARRIAGE BOLTS (T) PREVIOUSLY INSTALLED IN THE LOWER BRACKET, GO UNDER THE BRAKE LINE BEHIND THE AXLE ON THE LEFT SIDE (DRIVER SIDE) AND GO REARWARD OF THE BRAKE LINE ON THE RIGHT SIDE (PASSENGER).

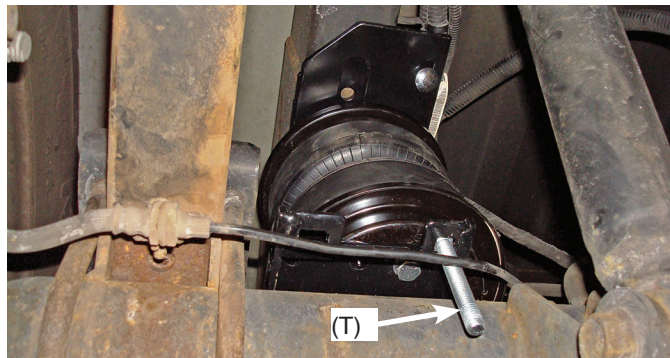

*fig. 13*

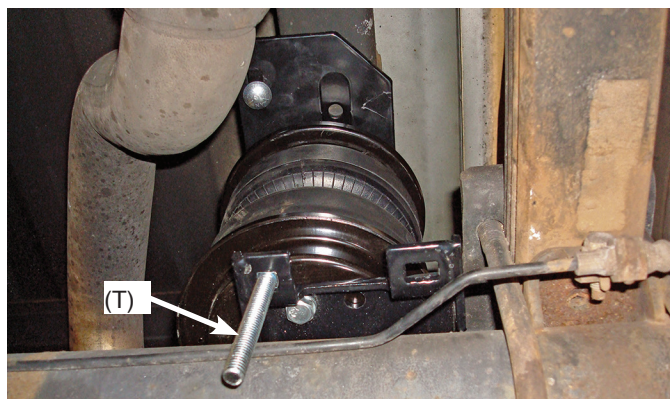
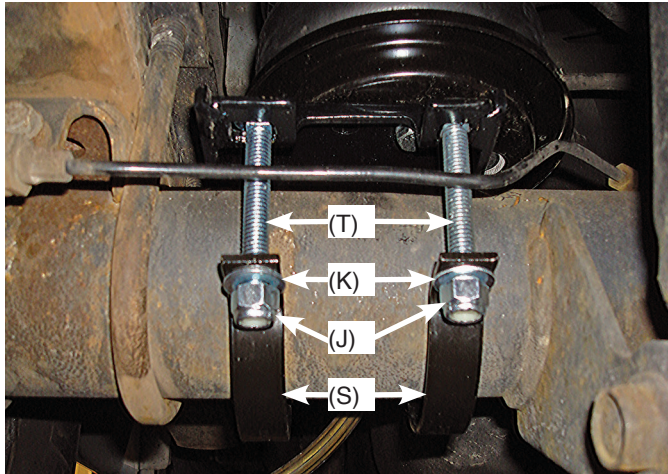

*fig. 14*

2. Insert the remaining 3/8-16 X 3.0" Carriage Bolts (T) into both lower brackets.

## NOTE

The remaining bolts (behind the axle) will go between the brake lines and the axle (figs. 15 & 16).



**Left (driver) side lower bracket attachment shown.**

Install axle straps (S) and cap with Flat Washers (K) and Nylon Lock Nuts (J).

Align upper and lower brackets before torquing.

*fig. 15*

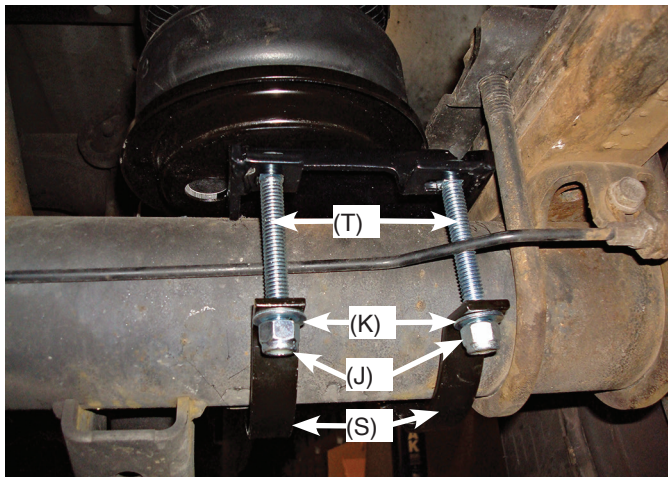

**Right (passenger) side lower bracket attachment shown.**

The inside bolt goes behind the brake line, the outside bolt goes between the brake line and axle (as shown).

*fig. 16*

3. Set the Axle Straps (S) over the Carriage bolts and cap with 3/8" Flat Washers (K) and 3/8" Nylon Lock Nuts (J).
4. With the axle raised all the way up, align the upper and lower brackets by pushing the upper bracket forward or backward. Torque the upper bracket hardware to 16 lb.-ft.
5. Evenly torque the lower bracket hardware to 10 lb.-ft.

## CAUTION

IF THE BRAKE LINES HIT OR RUB ON THE CARRIAGE BOLTS WHEN TORQUED DOWN. SLIGHTLY ADJUST THE LINES SO THAT THERE IS A LITTLE CLEARANCE BETWEEN BOTH.

# Installing the Air Lines

This section explains how to set up the air spring kit to be controlled with Schrader valves and a separate compressed air source. An on-board air compressor system allows for hassle-free control of the air springs. Learn more about Air Lift control systems at [www.airliftcompany.com/products/compressor-systems](http://www.airliftcompany.com/products/compressor-systems).

1. Choose a convenient location for mounting the inflation valves. Popular locations for the inflation valve are:
  - a. The wheel well flanges
  - b. The license plate recess in bumper
  - c. Under the gas cap access door
  - d. Through the license plate

## NOTE

*Whatever the chosen location, make sure there is enough clearance around the inflation valves for an air chuck.*

2. Drill 5/16" holes to install the inflation valves.
3. Cut the air line assembly in two equal lengths.
4. Place a 5/16" nut and star washer on the air valve. Leave enough of the inflation valve in front of the nut to extend through the hole and have room for the rubber washer, flat washer, and 5/16" nut and cap. There should be enough valve exposed after installation – approximately 1/2" – to easily apply a pressure gauge or an air chuck (fig. 17).

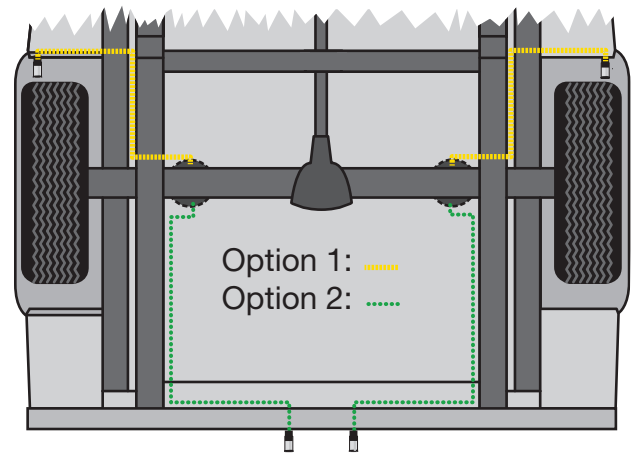

fig. 17

5. Push the inflation valve through the hole and use the rubber washer, flat washer and another 5/16" nut to secure it in place (fig. 18). Tighten the nuts to secure the assembly.

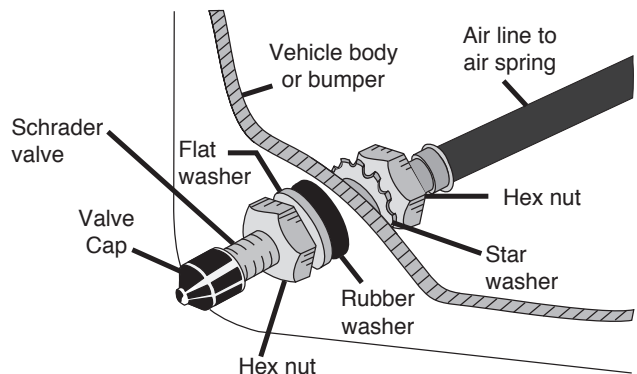

fig. 18

6. Route the air line along the frame to the fitting on the air spring. Keep AT LEAST 6" of clearance between the air line and the exhaust system. Avoid sharp bends and edges. Use zip ties to secure the air line to fixed points along the chassis. Be sure that the tie straps are tight, but do not pinch the air line. Leave at least 2" of slack to allow for any movement that might pull on the air line.
7. Cut off the air line, leaving approximately 12" of extra air line. A clean square cut will prevent leaks. Insert the air line into the air fitting. This is a push-to-connect fitting. Simply push the air line into the 90° swivel fitting until it bottoms out (9/16" of air line should be in the fitting).

## TIPS FOR INSTALLING AIR LINES

When cutting air lines, use a sharp knife or a hose cutter and make clean, square cuts (fig. 19). Do not use scissors or wire cutters because these tools may deform the air line, causing it to leak around fittings. Do not cut the lines at an angle.

Do not bend the 1/4" hose at a radius of less than 1" or bend the 3/8" hose at a radius of less than 1 1/2". Do not put side load pressure on fitting. The hose should be straight beyond the fitting for 1" before bending.

Inspect hose for scratches that run lengthwise on hose prior to installation. Contact Air Lift customer service at (800) 248-0892 if the air line is damaged.



To watch a video demonstrating proper air line cutting, go to [air-lift.co/cuttingairline](http://air-lift.co/cuttingairline).

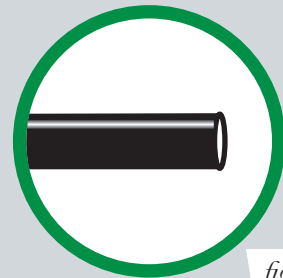

fig. 19



## PUSH-TO-CONNECT (PTC) FITTINGS

Air lines should be pushed into the push-to-connect fittings firmly, with a slight side-to-side rotational twist. Check the connection by pulling on each line to verify a robust connection.

### NOTE

To release the air line from the connection (fig. 20), first release all air from the system. Push in on the air line (step 1), push the collar in (step 2), and with the collar depressed, pull the air line out of the fitting (step 3).

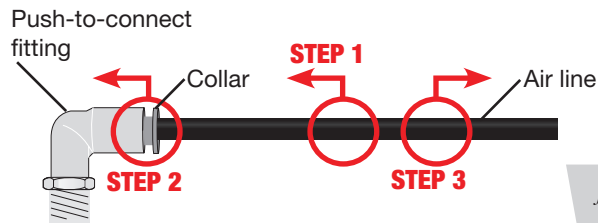

fig. 20

## INSTALLING THE HEAT SHIELD

**NOTE**

*The heat shield is installed on the exhaust pipe at the closest point to the air spring to protect the unit from the radiant heat of the exhaust system.*

1. The hose heat shield goes on the right side where the hose goes into the fitting on the bellows assembly.
2. Attach radiator clamps loosely around the exhaust pipe nearest to the spring.
3. Bend the heat shield tab out at a 90° angle and again half the distance up at a 90° angle to form an “L” shape (fig. 21). Repeat on the other tab. Position the heat shield and insert the heat shield tabs beneath the two radiator clamps. Tighten the clamps (fig. 22).

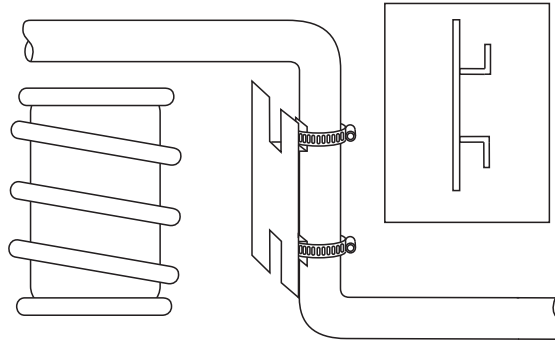

*fig. 21*

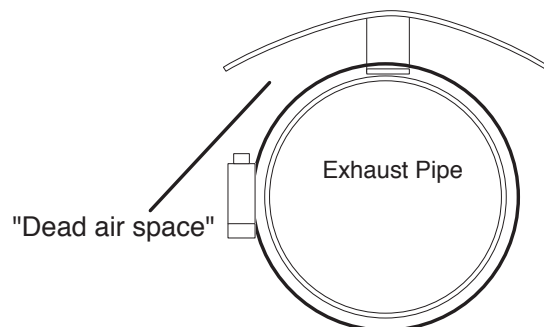

*fig. 22*

4. Bend the heat shield to form it around the tail pipe. Be sure to maintain a “dead air” space of 1/2” to 1” between the tail pipe and the heat shield (fig. 23).

**NOTE**

*Make sure installation does not interfere with moving parts, gas lines, etc.*



*fig. 23*

# Finished Installation Photos

1. The following images show the finished installation of both sides. (Figs. 24, 25, 26 & 27)

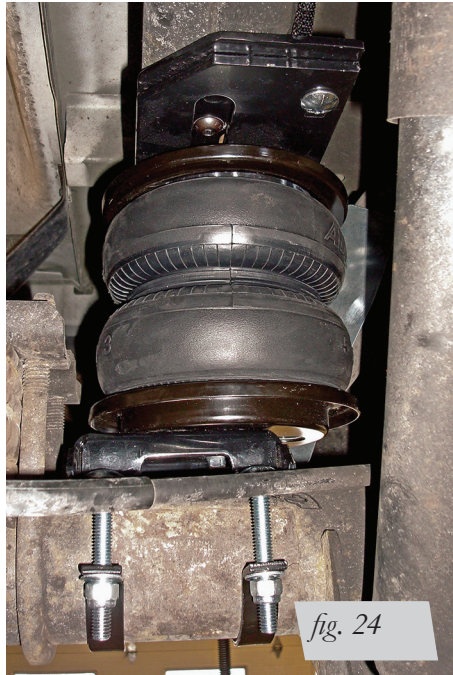

*fig. 24*

Front view of the right (passenger) side assembly.

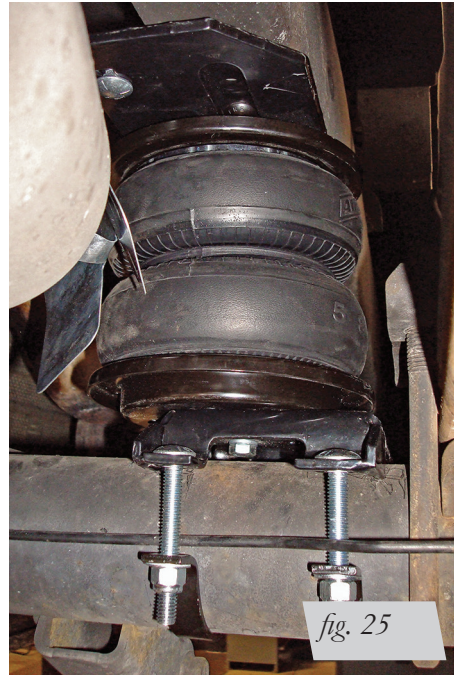

*fig. 25*

Rear view of the right (passenger) side.



*fig. 26*

Rear view of the left (driver) side assembly.

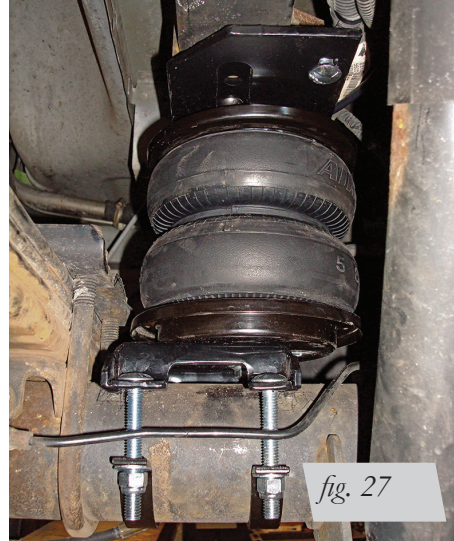

*fig. 27*

Rear view of the left (driver) side installation.



# Before Operating

## CHECKING FOR LEAKS

1. Inflate the air spring to 30 PSI.
2. Spray all connections and the inflation valves with a solution of 1/5 liquid dish soap and 4/5 water. Spot leaks easily by looking for bubbles in the soapy water.
3. After the test, deflate the springs to the minimum pressure required to restore the system to normal ride height. Do not deflate to lower than 5 PSI.
4. Check the air pressure again after 24 hours. A 2-4 PSI loss after initial installation is normal. Retest for leaks if the loss is more than 5 PSI.

## FIXING LEAKS

1. If there is a problem with the swivel fitting:
  - a. Check the air line connection by deflating the spring and removing the line by pulling the collar against the fitting and pulling firmly on the air line. Trim 1" off the end of the air line. Be sure the cut is clean and square (see fig. 19). Reinsert the air line into the push-to-connect fitting.
  - b. Check the threaded connection by tightening the swivel fitting another half turn. If it still leaks, deflate the air spring, remove the fitting, and re-coat the threads with thread sealant. Reinstall by hand tightening as much as possible and then use a wrench for an additional two turns.
2. If there is a problem with the inflation valve:
  - a. Check the valve core by tightening it with a valve core tool.
  - b. Check the air line by removing the air line from the barbed type fitting. Cut the air line off a few inches in front of the fitting and use a pair of pliers or vice grips to pull/twist the air line off of the fitting.



### CAUTION

DO NOT CUT OFF THE AIR LINE COMPLETELY AS THIS WILL USUALLY NICK THE BARB AND RENDER THE FITTING USELESS.

3. If the preceding steps have not resolved the problem, call Air Lift customer service at **(800) 248-0892**.

## INSTALLATION CHECKLIST

- Clearance test** — Inflate the air springs to 75-90 PSI and make sure there is at least 1/2" clearance from anything that might rub against each sleeve. Be sure to check the tire, brakes, frame, shock absorbers and brake cables.
- Leak test before road test** — Inflate the air springs to 75-90 PSI and check all connections for leaks. All leaks must be eliminated before the vehicle is road tested.
- Heat test** — Be sure there is sufficient clearance from heat sources, at least 6" for air springs and air lines. If a heat shield was included in the kit, install it. If there is no heat shield, but one is required, call Air Lift customer service at **(800) 248-0892**.
- Fastener test** — Recheck all bolts for proper torque.
- Road test** — The vehicle should be road tested after the preceding tests. Inflate the springs to recommended driving pressures. Drive the vehicle 10 miles and recheck for clearance, loose fasteners and air leaks.
- Operating instructions** — If professionally installed, the installer should review the operating instructions with the owner. Be sure to provide the owner with all of the paperwork that came with the kit.

## POST-INSTALLATION CHECKLIST

- Overnight leak down test** — Recheck air pressure after the vehicle has been used for 24 hours. If the pressure has dropped more than 5 PSI, then there is a leak that must be fixed. Either fix the leak yourself or return to the installer for service.
- Air pressure requirements** — It is important to understand the air pressure requirements of the air spring system. Regardless of load, the air pressure should always be adjusted to maintain adequate ride height at all times while driving.
- Thirty-day or 500-mile test** — Recheck the air spring system after 30 days or 500 miles, whichever comes first. If any part shows signs of rubbing or abrasion, the source should be identified and moved, if possible. If it is not possible to relocate the cause of the abrasion, the air spring may need to be remounted. If professionally installed, the installer should be consulted. Check all fasteners for tightness.

# Product Use, Maintenance and Servicing

| Minimum Recommended Pressure | Maximum Air Pressure |
|------------------------------|----------------------|
| 5 PSI                        | 100 PSI              |

## MAINTENANCE GUIDELINES

**NOTE**

*By following the steps below, vehicle owners will obtain the longest life and best results from their air springs.*

 **CAUTION**

1. Check air pressure weekly.
  2. Always maintain normal ride height. Never inflate beyond 100 PSI.
  3. If you develop an air leak in the system, use a soapy water solution (1/5 liquid dish soap and 4/5 water) to check all air line connections and the inflation valve core before deflating and removing the air spring.
- FOR SAFETY AND TO PREVENT POSSIBLE DAMAGE TO THE VEHICLE, DO NOT EXCEED MAXIMUM GROSS VEHICLE WEIGHT RATING (GVWR), AS INDICATED BY THE VEHICLE MANUFACTURER. ALTHOUGH THE AIR SPRINGS ARE RATED AT A MAXIMUM INFLATION PRESSURE OF 100 PSI, THE AIR PRESSURE ACTUALLY NEEDED IS DEPENDENT ON LOAD AND GVWR.
4. Loaded vehicles require at least 25 PSI. A “loaded vehicle” refers to a vehicle with a heavy bed load, a trailer or both. Never exceed GVWR, regardless of air spring, air pressure or other load assist. The springs in this kit will support approximately 40 pounds of load (combined on both springs) for each 1 PSI of pressure. The required air pressure will vary depending on the state of the original suspension. Operating the vehicle below the minimum air spring pressure will void the Air Lift warranty.
  5. When increasing load, always adjust air pressure to maintain normal ride height. Increase or decrease pressure from the system as necessary to attain normal ride height for optimal ride and handling. Remember that loads carried behind the axle (including tongue loads) require more leveling force (pressure) than those carried directly over the axle.
  6. Always add air to springs in small quantities, checking the pressure frequently.
  7. Should it become necessary to raise the vehicle by the frame, make sure the system is at minimum pressure (5 PSI) to reduce the tension on the suspension/ brake components. Use of on-board leveling systems do not require deflation or disconnection.
  8. Periodically check the air spring system fasteners for tightness. Also, check the air springs for any signs of rubbing. Realign if necessary.
  9. On occasion, give the air springs a hard spray with a garden hose to remove mud, sand, gravel or other debris.

## TUNING THE AIR PRESSURE

Pressure determination comes down to three things — level vehicle, ride comfort and stability.

### 1. Level vehicle

If the vehicle's headlights are shining into the trees or the vehicle is leaning to one side, then it is not level (fig. 28). Raise the air pressure to correct either of these problems and level the vehicle.

### 2. Ride comfort

If the vehicle has a rough or harsh ride it may be due to either too much pressure or not enough (fig. 29). Try different pressures to determine the best ride comfort.

### 3. Stability

Stability translates into safety and should be the priority, meaning the driver may need to sacrifice a perfectly level and comfortable ride. Stability issues include roll control, bounce, dive during braking and sponginess (fig. 30). Tuning out these problems usually requires an increase in pressure.

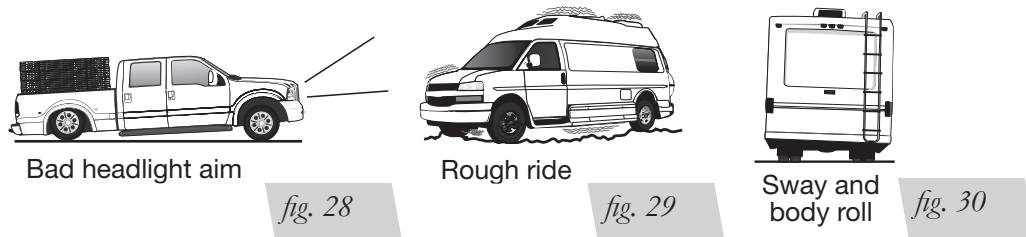

## GUIDELINES FOR ADDING AIR

1. Start with the vehicle level or slightly above.
2. When in doubt, always add air.
3. If the front of the vehicle dives while braking, increase the pressure in the front air bags, if equipped.
4. If it is ever suspected that the air bags have bottomed out, increase the pressure (fig. 31).
5. Adjust the pressure up and down to find the best ride.
6. If the vehicle rocks and rolls, adjust the air pressure to reduce movement.
7. It may be necessary to maintain different pressures on each side of the vehicle. Loads such as water, fuel, and appliances will cause the vehicle to be heavier on one side (fig. 32). As much as a 50 PSI difference is not uncommon.

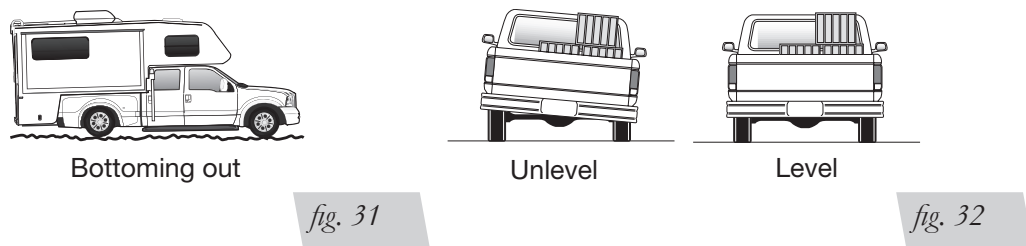

# Troubleshooting Guide

| PROBLEM                                   | CAUSE  | SOLUTION   |
|---|--|--|
| System won't maintain pressure overnight. | Improperly installed air line, air line has holes or cracks. | Leak test the air line connections, the threaded connection into the air spring, and all fittings in the control system.                               |
| Air spring or air line leak.              | Fitting seal or air line is compromised.                     | Check to make sure air lines are seated in connectors. Inspect fittings with soapy water. Trim hose or re-seal fitting. Ensure lines are cut straight. |
| Corner won't raise or air leak develops.  | Look for a kink or fold in the air line.                     | Replace any air line that has been kinked.   |

## FREQUENTLY ASKED QUESTIONS

**Q. Will installing air springs increase the weight ratings of a vehicle?**

No. Adding air springs will not change the weight ratings (GAWR, GCWR and/or GVWR) of a vehicle. Exceeding the GVWR is dangerous and voids the Air Lift warranty.

**Q. Is it necessary to keep air in the air springs at all times and how much pressure will they need?**

For LoadLifter 5000, Ultimate, the recommended chain pressure is 5 PSI to 15 PSI, but it is safe to use at a lower air pressure.

**Q. Is it necessary to add a compressor system to the air springs?**

No. Air pressure can be adjusted with any type of compressor as long as it can produce sufficient pressure to service the springs. Even a bicycle tire pump can be used, but it's a lot of work.

**Q. How long should air springs last?**

If the air springs are properly installed and maintained they can last indefinitely.

**Q. Will raising the vehicle on a hoist for service work damage the air springs?**

No. The vehicle can be lifted on a hoist for short-term service work such as tire rotation or oil changes. However, if the vehicle will be on the hoist for a prolonged period of time, support the axle with jack stands in order to take the tension off of the air springs.



# Notes

# Limited Warranty and Return Policy

Air Lift Company provides a limited lifetime warranty to the original purchaser of its Load Support products, that the products will be free from defects in workmanship and materials when used on cars and trucks as specified by Air Lift Company and under normal operating conditions, subject to the requirements and exclusions set forth in the full Limited Warranty and Return Policy that is available online at [www.airliftcompany.com/warranty](http://www.airliftcompany.com/warranty).

For additional warranty information contact Air Lift Company customer service.

# Replacement Part Information

If replacement parts are needed, contact the local dealer or call Air Lift customer service at **(800) 248-0892**. Most parts are immediately available and can be shipped the same day.

**Contact Air Lift Company customer service at (800) 248-0892 first if:**

- Parts are missing from the kit.
- Need technical assistance on installation or operation.
- Broken or defective parts in the kit.
- Wrong parts in the kit.
- Have a warranty claim or question.

**Contact the retailer where the kit was purchased:**

- If it is necessary to return or exchange the kit for any reason.
- If there is a problem with shipping if shipped from the retailer.
- If there is a problem with the price.

# Contact Information

|                                     |  |
|-------------------------------------|--|
| <b>Mailing address</b>              | P.O. Box 80167<br>Lansing, MI 48908-0167                                   |
| <b>Shipping address for returns</b> | 2727 Snow Road<br>Lansing, MI 48917  |
| <b>Phone</b>                        | Toll free: (800) 248-0892<br>International: (517) 322-2144                 |
| <b>Email</b>                        | <a href="mailto:service@airliftcompany.com">service@airliftcompany.com</a> |
| <b>Web address</b>                  | <a href="http://www.airliftcompany.com">www.airliftcompany.com</a>         |

## Need Help?

Contact Air Lift Company customer service department by calling (800) 248-0892. For calls from outside the USA or Canada, dial (517) 322-2144.



*Thank you for purchasing Air Lift products — the professional installer's choice!*

Air Lift Company • 2727 Snow Road • Lansing, MI 48917 or P.O. Box 80167 • Lansing, MI 48908-0167  
Toll Free (800) 248-0892 • Local (517) 322-2144 • Fax (517) 322-0240 • [www.airliftcompany.com](http://www.airliftcompany.com)

Printed in the USA  
JJC-0916