



# RideCONTROL™

Kit No. 59537

MN-461  
(021108)  
ECR 7136

*Please read these instructions completely before proceeding with installation*

## Air Spring Kit Parts List

Item	Description	Quantity
A	Air Sleeves	2
B	Upper Brackets	2
C	Lower Brackets	2
D	Jounce Bumper Spacer	2
E	Low Profile Elbow Fitting	2

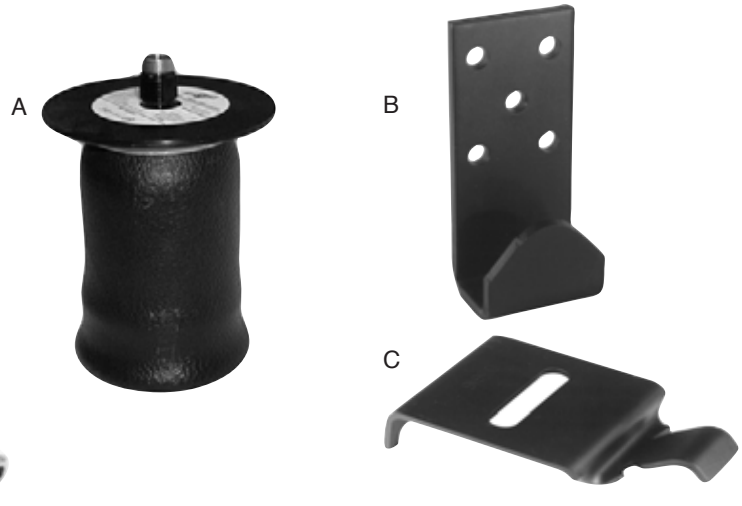

## Bracket Attaching Hardware

Item	Description	Quantity
F	3/8" -16 U-Bolts	2
G	Clamp Bar	2
H	3/8" Nylock Nuts	6
I	3/8" Flat Washers	6
J	3/8" x 1" WHST	6
K	3/8" x 1" HHCS	2

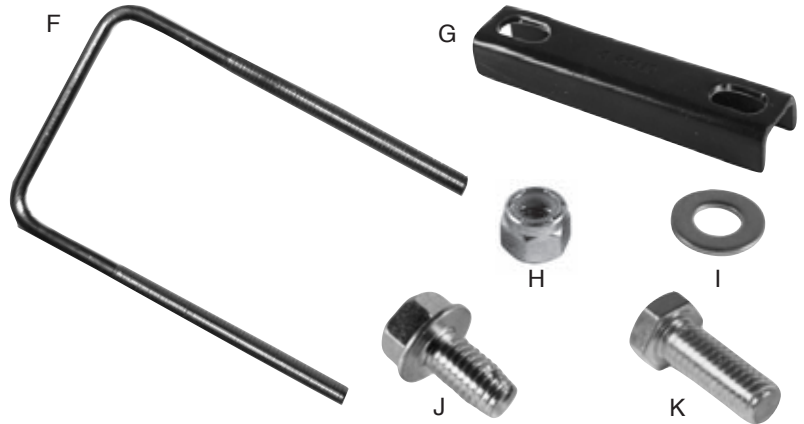

## Air Spring Attaching Hardware

Item	Description	Quantity
L	1/2" x 7/8" Hex Head Bolts	2
M	3/4" Hex Jam Nut	2
N	1/2" Flat Washers	2

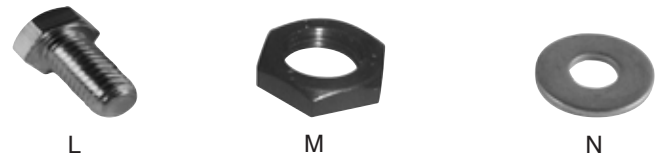

## Air Line Assembly Parts List

Item	Description	Quantity
AA	Air Line Assembly	1
BB	Tie Strap	6
CC	Valve Caps	2
DD	5/16" Flat Washer	2
EE	Rubber Washer	2
FF	Small Star Washer	2
GG	5/16" Hex Nut	4
HH	Hose Clip	4

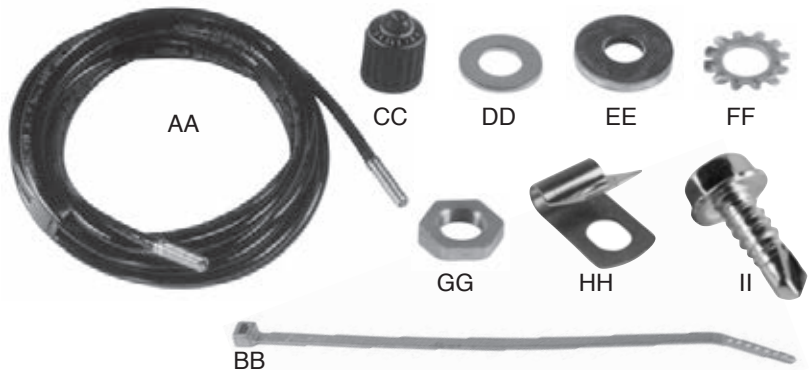

Technical Support  
1-800-248-0892  
Ext. 2

## Tools Needed

Standard and metric open end or box wrenches  
Ratchet with  $\frac{3}{8}$ ",  $\frac{1}{2}$ ", &  $\frac{9}{16}$ " deep well sockets  
 $\frac{5}{16}$ " drill bit (very sharp)  
 $\frac{7}{16}$ " &  $\frac{9}{16}$ " Nut Drivers  
Heavy Duty Drill  
Torque Wrench

Hose Cutter, Razor Blade, or Sharp Knife  
Hoist or Floor Jacks  
Safety Stands  
Safety Glasses  
Air Compressor, or Compressed Air Source  
Spray Bottle with Dish Soap/Water Solution



**IMPORTANT:** Your vehicle may be equipped with a rear brake proportioning valve. Any type of load assist product could affect brake performance. We recommend that you check with your dealer before installing this type of product. If your vehicle DOES NOT have a rear brake proportioning valve or is equipped with an anti-lock type brake system, installation of a load assist product will have NO EFFECT ON BRAKE SYSTEM PERFORMANCE.

**IMPORTANT:** Failure to maintain correct minimum pressure (or pressure proportional to load), bottoming out, overextension, or rubbing against another component will void the warranty.

**DANGER:** Compressed air can cause injury and damage to the vehicle and parts if it is not handled properly. For your safety, do not try to inflate the air springs until they have been properly secured to the vehicle.



Figure 1



Figure 2

## I. Getting Started

1. Determine the Normal Ride Height. **The Normal Ride Height is the distance between the bottom edge of the wheel-well and the center of the hub with the vehicle in the "as delivered" condition.** In some cases, Normal Ride Height is not perfectly level.
  - a. Remove unusual loads and examine your vehicle from the side to ensure it is on a level surface (Figure 1).
  - b. If necessary (in cases where your leaf springs are sagging badly), use a jack to raise the rear end so that the vehicle achieves the original "as delivered" ride height.
2. Measure the distance between the center of the hub and the bottom edge of the wheel well (Figure 2). This is the Normal Ride Height. Enter the measurement below:

NORMAL  
RIDE HEIGHT: \_\_\_\_\_ inches

## II. Assembling the Air Spring Unit

1. Install 90 degree air swivel fitting (E) to the top of the air spring. Use an open end wrench being careful to tighten on the metal hex nut only. Tighten 1 and  $\frac{1}{2}$  turns (Figure 3). Do not over tighten.

**NOTE: This fitting is precoated with sealant.**

2. Set upper bracket (B) over the fitting and thread post (Figure 4). Position the elbow towards the front or rear of the vehicle depending on which direction will allow easier access for the air line.

3. Thread nylon nut (M) onto the thread post, making sure that the flat side is up (Figure 5).

4. Tighten the nylon nut. Hand tight is sufficient.

**IMPORTANT: Ensure that the bracket is tight and flat to the roll plate on both sides.**

5. Loosely attach the lower bracket (E) to the bottom of the air spring with  $\frac{1}{2}$ " flat washer (N) and  $\frac{1}{2}$ " Hex Head Cap Screw (L). See Figure 6.



Figure 3



Figure 4

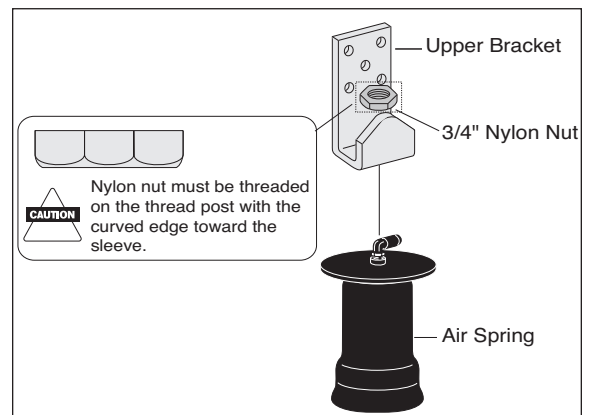

Figure 5

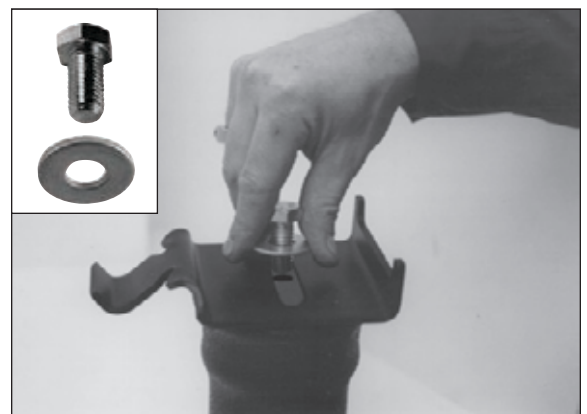

Figure 6

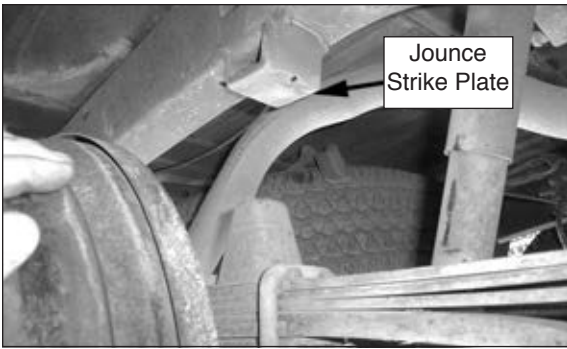

Figure 7



Figure 8



Figure 9



Figure 10

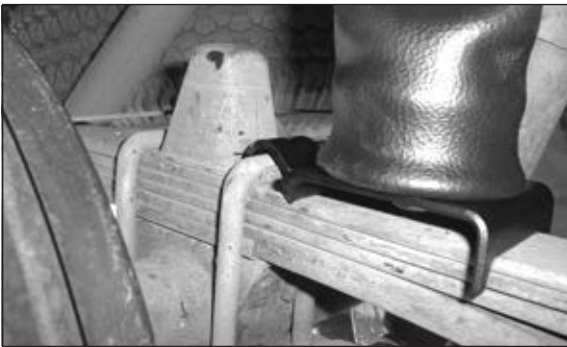

Figure 11

### III. Installing the Jounce Spacer

1. For heavy load usage, we recommend installing a jounce bumper strike plate spacer (D) under the stock strike plate (Figure 7).
2. Position the strike plate spacer (D) flush with the back bottom edge of the stock strike plate and mark the mounting hole location using a pencil or marker (Figure 8).

3. Centerpunch and drill a  $\frac{3}{8}$ " hole in the stock strike plate.

**NOTE:** *In order to gain more accessibility for drilling the mounting hole, it may be necessary to drop the axle. Keep safety in mind and use safety stands if needed.*

4. Bolt the strike plate spacer to stock strike plate using a  $\frac{3}{8}$ " bolt (K), two washers (I), and a nylock nut (H). See Figure 10. Torque to 16 ft-lbs.

### IV. Mounting the Lower Bracket

**IMPORTANT:** *If the axle was dropped to install the jounce strike plate spacer, it will be necessary to raise it back to the normal ride height recorded on page 2.*

1. With the vehicle at normal ride height, with the hook end of the lower bracket over the factory U-bolt, set the air spring assembly on the leaf spring forward of the axle (Figure 11).
2. Secure the lower bracket to the leaf spring using U-bolt (F), clamp bar (G), flat washer (I), and nylock nut (H). See Figure 12. Tighten to 16 ft-lbs.

## V. Locating the Upper Bracket

1. The upper bracket must be parallel and perpendicular to the lower bracket as shown in the illustration in Figure 13.
2. Align the upper bracket so that the short leg of the upper bracket touches the bottom of the frame rail (Figure 14).
3. Using the upper bracket as a template, centerpunch one hole (Figure 15). A welding clamp or C-clamp may assist in holding the upper bracket to the frame.

**NOTE:** It is necessary to use at least three of the five pre-drilled holes in the upper bracket for mounting. Any combination of the three is permissible.

4. **CAUTION:** Before drilling, be sure to check the back side of the frame rail for brake lines, gas lines, or electrical lines that may be in the way. It is necessary to move any interfering lines prior to drilling.
  5. Drill one  $\frac{5}{16}$ " hole and install one WHST (J). See Figure 16. Tighten to 15 ft-lbs.
- IMPORTANT:** Check again to make sure that the upper and lower brackets are parallel and perpendicular to each other (Figure 13).
6. Centerpunch and drill remaining two holes and install the WHST (J). Again, torque to 15 ft-lbs. Do not over tighten.

## VI. Installing the Other Side

1. Install the minimum/maximum air pressure decal in a highly visible location.
2. Repeat entire installation procedure for remaining side.
3. Continue with section VII, Installing the Air Lines.

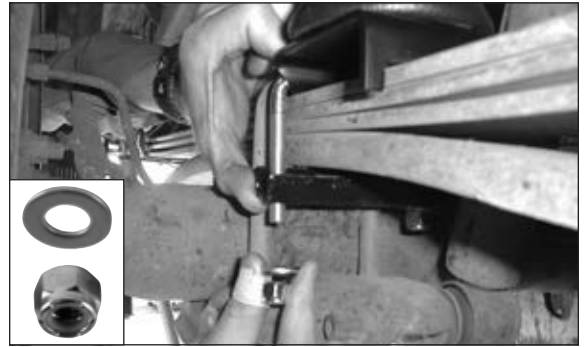

Figure 12

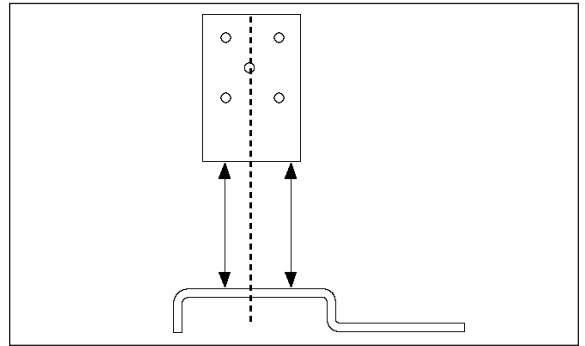

Figure 13

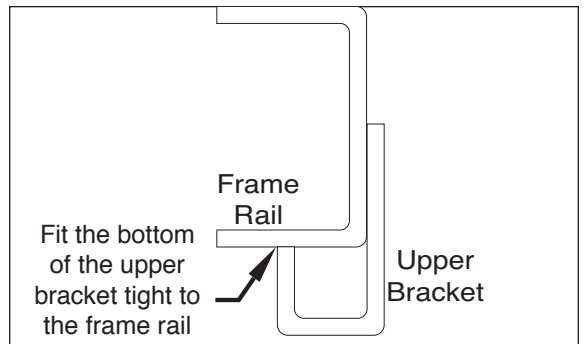

Figure 14



Figure 15



Figure 16



Figure 17

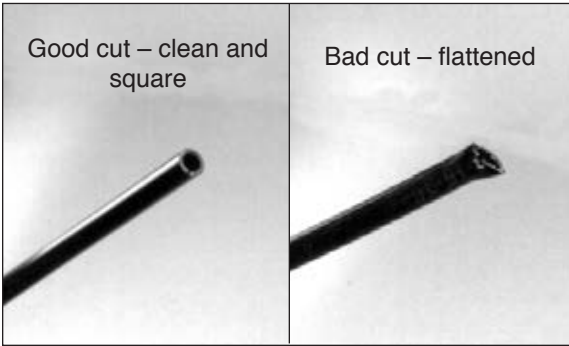

Figure 18a

Figure 18b



Figure 19

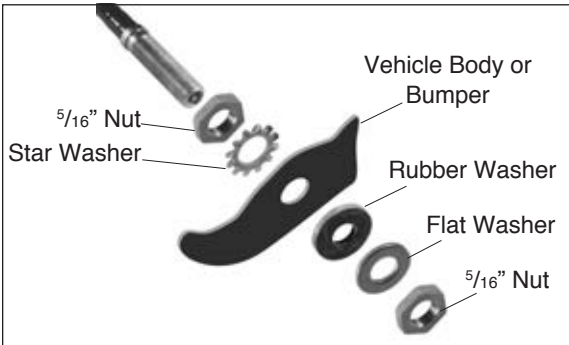

Figure 20

## VII. Installing the Air Lines

1. Choose a convenient location for mounting the inflation valves. Popular locations for the inflation valve are:
  - a. The wheel well flanges.
  - b. License plate recess in bumper.
  - c. Under the gas cap access door.
  - d. Through license plate itself.

**NOTE: What ever the chosen location is, make sure there is enough clearance around the inflation valves for an air chuck.**

2. Drill a  $\frac{5}{16}$ " hole to install the inflation valves.
3. Cut the air line assembly (AA) in two equal lengths (Figure 17).

**CAUTION: When cutting or trimming the air line, use a hose cutter (Air Lift P/N 10530), a razor blade or a sharp knife. A clean, square cut will ensure against leaks. (Figure 18a). Do not use wire cutters or scissors to cut the air line. These tools may flatten or crimp the air line, causing it to leak around the O-ring seal inside the elbow fitting (Figure 18b).**

4. Place a  $\frac{5}{16}$ " nut (GG) and a star washer (FF) on the air valve. Leave enough of the inflation valve in front of the nut to extend through the hole and have room for the rubber washer (EE), flat washer (DD), and  $\frac{5}{16}$ " nut (GG) and cap (CC). There should be enough valve exposed after installation - approximately  $\frac{1}{2}$ " - to easily apply a pressure gauge or an air chuck (Figure 19).
5. Push the inflation valve through the hole and use the rubber washer (EE), flat washer (DD), and another  $\frac{5}{16}$ " nut (GG) to secure it in place. Tighten the nuts to secure the assembly in place (Figure 20).

6. Route the air line along the frame to the air fitting on the air spring. Keep at least 6" of clearance between the air line and heat sources, such as the exhaust pipes, muffler, or catalytic converter. Avoid sharp bends and edges. Use the plastic tie straps (BB) to secure the air line to fixed, non-moving points along the chassis (Figure 21). Be sure that the tie straps are tight, but do not pinch the air line. Where there are no holes to secure the straps to, use the air line clip (HH) and self tapper (II) to secure the air line to the frame (Figure 22). Leave at least 2" of slack to allow for any movement that might pull on the air line.

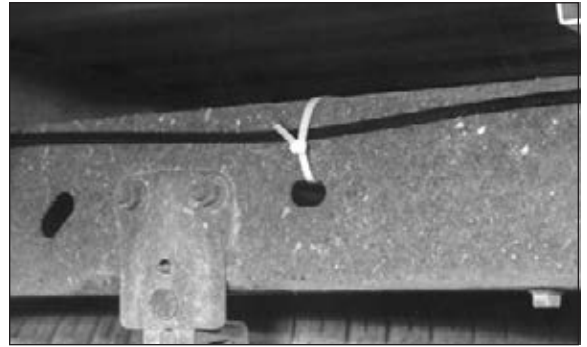

*Figure 21*

7. Cut off air line leaving approximately 12" of extra air line. A clean square cut will ensure against leaks. Insert the air line into the air fitting. This is a push to connect fitting. Simply push the air line into the 90° swivel fitting until it bottoms out ( $9/16$ " of air line should be in the fitting).

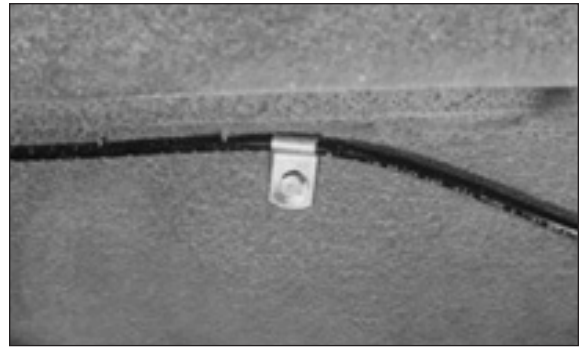

*Figure 22*



*Figure 23*

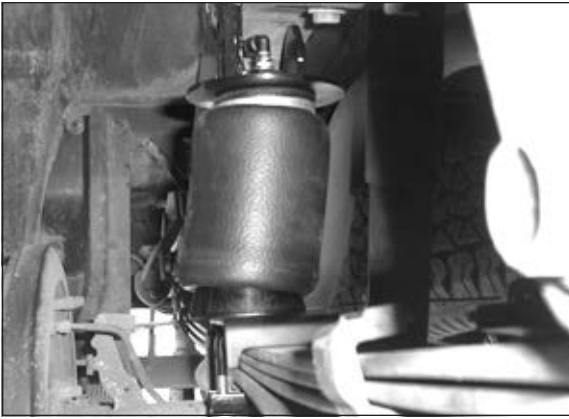

Figure 24

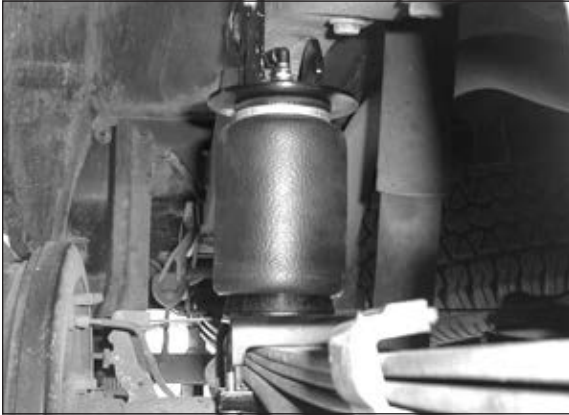

Figure 25



Figure 26

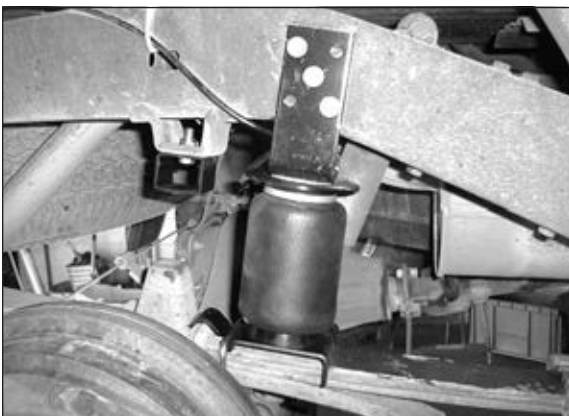

Figure 27

## VIII. Aligning the Air Springs

1. **IMPORTANT:** With the bottom of the air spring still loose, inflate the air spring to approximately 10 p.s.i. Use the slotted adjustment in the lower bracket to correctly align the air spring between the upper and lower bracket. This can be accomplished by tapping it inboard or outboard for proper alignment. There should be a symmetrical cushion of air around the base of the air spring when correctly positioned. Figure 24 represents a misaligned air spring. Figure 25 shows a properly aligned air spring.
2. When aligned, tighten the lower end by holding the air spring and turning the bolt with a  $\frac{3}{4}$ " open end wrench (Figure 26). Snug (10 ft-lbs) will be sufficient and will also prevent stripping the threads. ***Do not attempt to hold the air spring with any type of tool.***
3. Figure 27 shows the completed installation.



## IX. Checking for Leaks

1. Inflate the air spring to 60 p.s.i.
2. Spray all connections and the inflation valves with a solution of  $\frac{1}{5}$  liquid dish soap and  $\frac{4}{5}$  water to check for leaks (Figure 28). You should be able to spot leaks easily by looking for bubbles in the soapy water.
3. After the test, deflate the springs to the minimum pressure required to restore the Normal Ride Height, but not less than 10 p.s.i.
4. **IMPORTANT:** Check the air pressure again after 24 hours. A 2 to 4 p.s.i. loss after initial installation is normal. Retest for leaks if the loss is more than 5 lbs.



**Figure 28**

## X. Fixing Leaks

1. If there is a problem with the swivel fitting, then:
  - a. Check the air line connection by deflating the spring and removing the line by pulling the collar against the fitting and pulling firmly on the air line. Trim 1" off the end of the air line. Be sure the cut is clean and square. Reinsert the air line into the push-to-connect fitting. See Figure 29.
  - b. Check the threaded connection by tightening the swivel fitting another  $\frac{1}{2}$  turn. If it still leaks, deflate the air spring, remove the fitting, and re-coat the threads with thread sealant. Reinstall by hand tightening as much as possible, then use a wrench for an additional two turns. See Figure 29.
2. If there is a problem with the inflation valve, then:
  - a. Check the valve core by tightening the it with a valve core tool.
  - b. Check the air line connection (Figure 30) by removing the air line from the barbed type fitting. **CAUTION: Do not cut it off. As this will usually nick the barb and render the fitting useless.** Cut air line off a few inches in front of the fitting and use a pair of pliers or vise-grips to pull/twist the air line off the fitting.
3. If the preceding steps have not resolved the problem, call Air Lift Technical Service at 1-800-248-0892 for assistance.

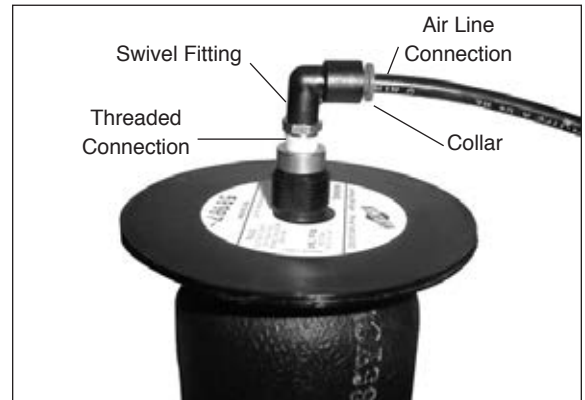

**Figure 29**

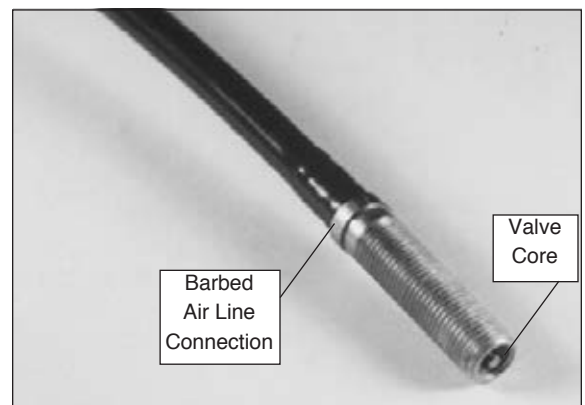

**Figure 30**



**Figure 31**

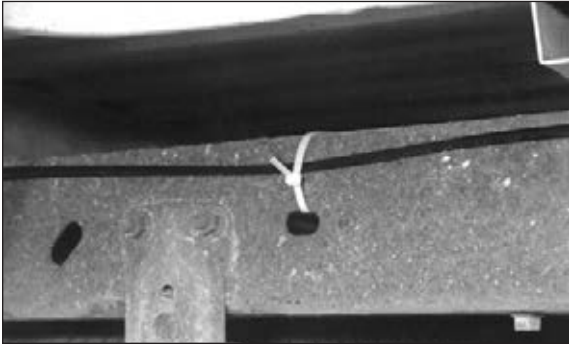

**Figure 32**

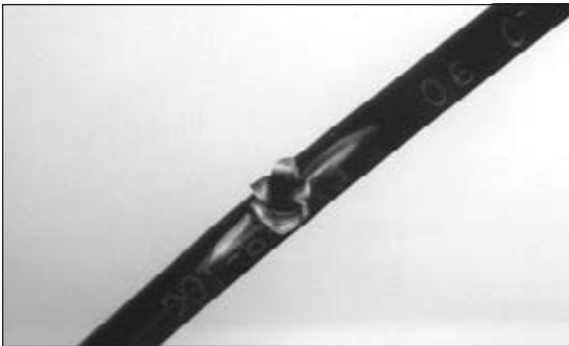

**Figure 33**



**Figure 34**

## XI. Troubleshooting Guide

### ***Problems maintaining air pressure, without on-board compressor.***

1. Leak test the air line connections and threaded connection of the elbow into the air spring (Figure 28). See Section X to repair.
2. Leak test the inflation valve for leaks at the air line connection or dirt or debris in the valve core (Figure 31). See Section X for repair.
3. Inspect air lines to be sure it is not pinched. Tie straps may be too tight. Loosen or replace strap. Replace leaking components (Figure 32).
4. Inspect air line for holes and cracks (Figure 33). Replace as needed.
5. A kink or fold in the air line (Figure 34). Reroute as needed.

***You have now tested for all of the most probable leak conditions that can be easily fixed. At this point the problem is most likely a failed air spring - either a factory defect or an operating problem. Please call Air Lift at 1-800-248-0892 for assistance or a replacement air spring.***

## XI. Checklist

**You can protect your warranty on this product and prevent unnecessary wear by ensuring the following checks have been made:**

### Section I – Installation (To be completed by the installer):

- 1. Clearance Test - Inflate the air springs to 60 p.s.i. and ensure there is at least 1/2 " clearance around each sleeve from anything that might rub against them. Be sure to check the tire, brake drum, frame, shock absorbers and brake cables.
- 2. Leak Test Before Road Test – Inflate the air springs to 60 p.s.i., check all connections for leaks with a soapy water solution. See pages 9 and 10 of the manual for tips on how to spot leaks. All leaks must be eliminated before the vehicle is road tested.
- 3. Heat Test – Be sure there is sufficient clearance from heat sources - at least 6" for air springs and air lines. If a heat shield was included in the kit - install it. If there is no heat shield, but one is required, call 1-800-248-0892.
- 4. Fastener Test – Recheck all bolts for proper torque.

#### Torque Guide:

WHST	15 ft-lbs
U-bolt Lock Nuts	16 ft-lbs
Lower Bolt for Air Spring	10 ft-lbs

- 5. Road Test – The vehicle should be road tested after the preceding tests. Inflate the springs to 25 p.s.i. (50 p.s.i. if vehicle is loaded). Drive the vehicle 10 miles and recheck for clearance, loose fasteners and/or air leaks.
- 6. Operating Instructions – If professionally installed, the installer should review the operating instructions on page 12 with the owner. Be sure to provide the owner with all of the paperwork that came with the kit.

### Section II - Post Installation Checklist (To be completed by the owner):

- 1. Overnight Leakdown Test – Recheck air pressure after vehicle has been used for 24 hours. If pressure has dropped more than 5 p.s.i. then, you have a leak that must be fixed. Either fix the leak yourself (see pages 9 and 10) or return to the installer for service.
- 2. Air Pressure Requirements – I understand that the air pressure requirements of my air spring system are as follows:

Minimum \_\_\_\_\_ Maximum \_\_\_\_\_

I also understand that I must inflate the air springs until the Ride Height measurement that was recorded on page 2 has been restored. Regardless of load, the air pressure should always be adjusted so that the Ride Height is maintained at all times.

- 3. Thirty Day or 500 Mile Test. I understand that I must recheck the air spring system after 30 days or 500 miles, whichever comes first. If any part shows signs of rubbing or abrasion, the source should be identified and moved, if possible. If it is not possible to relocate the cause of the abrasion, the air spring may need to be remounted. If professionally installed, the installer should be consulted. Check all fasteners for tightness.

## XII. Maintenance and Operations

Minimum Air Pressure	Maximum Air Pressure
5 p.s.i.	100 p.s.i.
<b><i>Failure to maintain correct minimum pressure (or pressure proportional to load), bottoming out, over-extension, or rubbing against another component will void the warranty.</i></b>	

By following these steps, vehicle owners will obtain the longest life and best results from their air springs.

1. Check the air pressure weekly.
2. Always maintain Normal Ride Height. Never inflate beyond 100 p.s.i.
3. If you develop an air leak in the system, use a soapy water solution to check all air line connections and the inflation valve core before deflating and removing the air spring. (See page 9.)
4. When increasing load, always adjust the air pressure to maintain the Normal Ride Height. Increase or decrease pressure from the system as necessary to attain Normal Ride Height for optimal ride and handling. Remember that loads carried behind the axle (including tongue loads) require more leveling force (pressure) than those carried directly over the axle.
5. **IMPORTANT:** For your safety and to prevent possible damage to your vehicle, **do not exceed maximum Gross Vehicle Weight Rating (GVWR), as indicated by the vehicle manufacturer.** Although your air springs are rated at a maximum inflation pressure of 100 p.s.i. The air pressure actually needed is dependant on your load and GVWR, which may be less than 100 p.s.i. Check your vehicle owners manual and do not exceed the maximum load listed for your vehicle.
6. Always add air to springs in small quantities, checking the pressure frequently. Sleeves require less air volume than a tire and inflate quickly.
7. **Should it become necessary to raise the vehicle by the frame, make sure the system is at minimum pressure (5 p.s.i.) to reduce the tension on the suspension/brake components. Use of on-board leveling systems do not require deflation or disconnection.**

### ***Thank you for purchasing Air Lift Products***



Mailing Address:  
AIR LIFT COMPANY  
P.O. Box 80167  
Lansing, MI 48908-0167

Street Address:  
AIR LIFT COMPANY  
2727 Snow Rd.  
Lansing, MI 48917

Local Phone: (517) 322-2144  
Fax: (517) 322-0240

For Technical Assistance call 1-800-248-0892

***“The Choice of the Professional Installer”***

Printed in the USA