

AIR LIFT 1000

MULTIPLE APPLICATIONS - SEE SPECIAL NOTES
FOR YOUR PARTICULAR VEHICLE.

BY



MN-71
(15612)
ECN1979

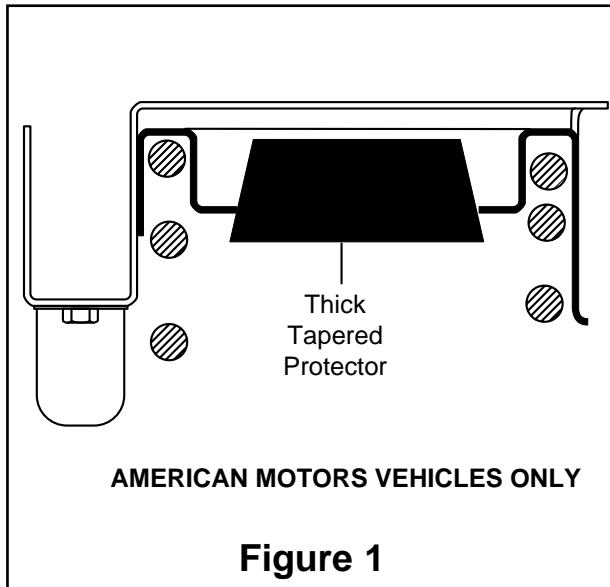

1. Air cylinders are shipped in the "as molded" shape. For ease of installation, remove plastic cap from barbed stem on end of cylinder. Push on air cylinder to exhaust as much air as possible. Replace cap on stem to maintain flat shape.
2. Lower axle or raise body of vehicle until suspension is fully extended. If necessary, additional clearance between the coil may be obtained by removing the shock absorbers from the lower shock mountings and lowering the suspension an additional one to two inches (CAUTION: OBSERVE TENSION ON BRAKE HOSE DO NOT STRAIN).

MITSUBISHI MONTERO APPLICATION:

NOTE: The thick tapered protector is not used for this application.

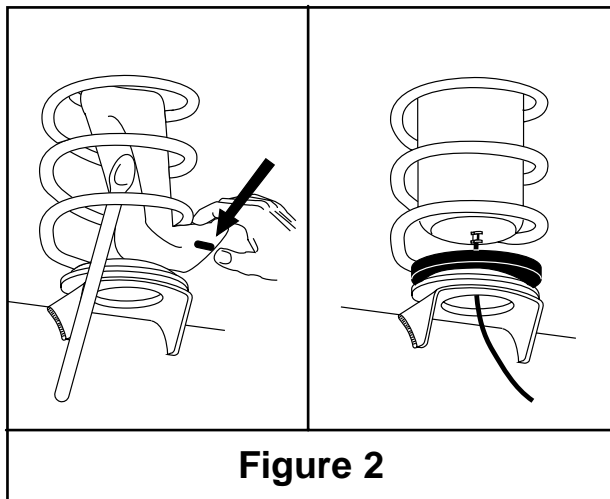

- A. Insert flattened air cylinder into lowest coil opening with stem towards the top (Figure 3). Push the cylinder up within the coil by hand or with a BLUNT instrument such as a spoon-type tire iron.
- B. When the cylinder is completely within the coil, remove the cap and allow the cylinder to assume its "as molded" shape.
- C. Push cylinder to the bottom of the coil spring. Insert the 1/2" thick protector on top of the air cylinder through coil opening and center over the barbed stem (Figure 3).

AMERICAN MOTORS APPLICATION

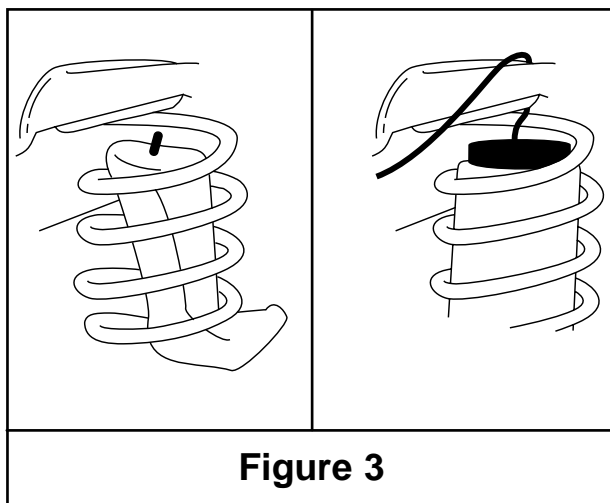

- A. Install the thick tapered protector into the hole in the upper spring seat (Figure 1).
- B. Insert flattened air cylinder into lowest coil opening with stem at the bottom (Figure 2). Push the cylinder up within the coil by hand or with a BLUNT instrument such as a spoon-type tire iron.
- C. When the cylinder is completely within the coil, remove the cap and allow the cylinder to assume its "as molded" shape.
- D. Push cylinder to the top of the coil spring. Insert lower protector through coil opening and center on axle spring seat (Figure 2).

3. Determine air line routing. A tee air line installation is recommended unless weight in vehicle varies from one side to the other and unequal pressures are needed to level load (or compensate for axle torque transfer in racing applications). Dual air lines are used in this case.

AIR LINE INSTRUCTIONS

CAUTION: LEAVE SUFFICIENT AIR LINE SLACK TO PREVENT ANY STRAIN ON FITTINGS DURING AXLE MOTIONS.

TO PREVENT AIR LINE FROM MELTING, KEEP IT AT LEAST TWELVE INCHES FROM EXHAUST SYSTEM, ENGINE AND HEAT SOURCES. CAUTION: AVOID AREAS WHICH MAY CAUSE FAILURE OF THE AIR LINE. FOR EXAMPLE: BATTERY, EXHAUST, ENGINE, AND MOVING PARTS SUCH AS STEERING, SUSPENSION AND CABLES.

TEE AIR LINE CONNECTION:

- A. Find desired tee location on the frame rail or radiator core support bracket (Figure 4).
- B. Determine and cut adequate length of air line to reach from tee to left and right side on air cylinders.
- C. Connect the air line to the two opposite legs on the tee (Figure 6).
- D. Route air line to left and right air springs, generally along inner fender panel or frame rails.
- E. Slide a air line clamp onto the air line. Push the air line over the barbed end of straight fitting. Compress the ears on the air line clamp with pliers and slide it down to cover the barbed section (Figure 6). Repeat for other side.
- F. Connect the straight fitting to the right & left air springs and tighten securely.
- G. Select a location for inflation valve in the hood release, front bumper, fender flange or behind the license plate, insuring that the valve will be protected and accessible with an air hose.
- H. Connect the remaining air line over the last fitting on tee and route along frame to desired inflation valve location. Attach air line to chassis with plastic straps or wire.
- I. Drill a 5/16" hole for inflation valve and mount as illustrated (Rubber washer is for outside weather seal (Figure 7).
- J. Connect the air line to the inflation valve.
- K. Continue with step 4.

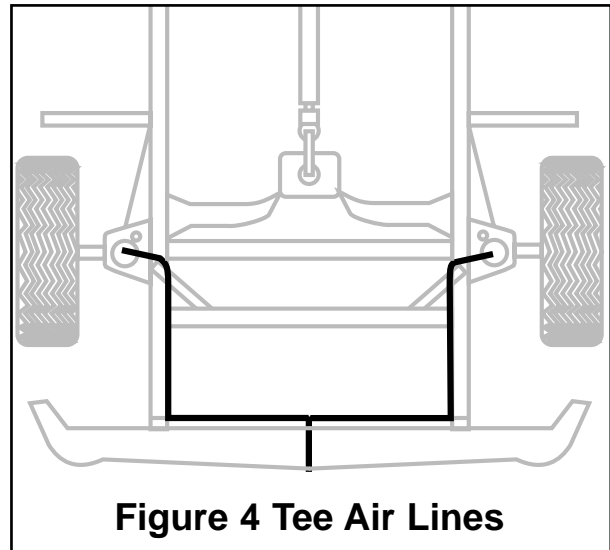

Figure 4 Tee Air Lines

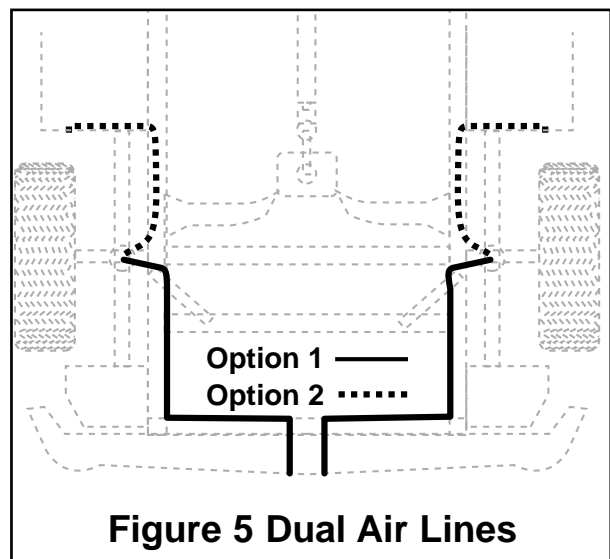
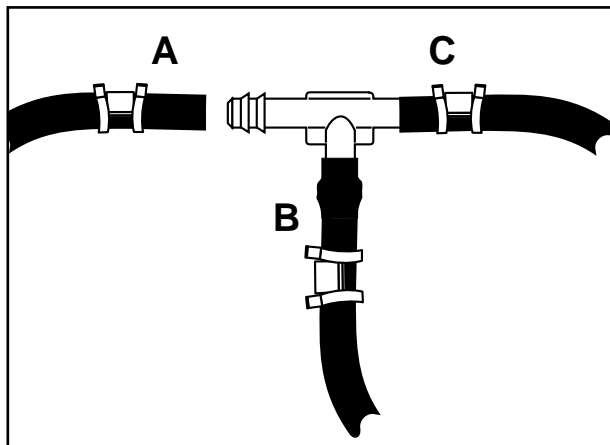

Figure 5 Dual Air Lines



Use this procedure for all air line connections:
A. Slide air line clamp onto the air line
B. Push the air line over the barbed stem.
C. Compress the ears on the air line clamp with pliers and slide it forward to fully cover the barbed section.
Figure 6

DUAL AIR LINE CONNECTION:

- A. Select a location for the inflation valves in the rocker panel flange or by hood release insuring that each valve will be protected and accessible with an air hose.
- B. Determine and cut adequate length, not longer than 90" of air line to reach from valve location to left side air cylinder.
- C. Slide air line clamp onto the air line. Push the air line over the barbed end of straight fitting. Compress the ears on the air line clamp with pliers and slide it down to cover the barbed section (Figure 6). Repeat for other side.
- D. Connect the straight fitting to the right & left air springs and tighten securely.
- E. Route air line along frame or under fender panel to desired inflation valve location (Figure 5). Attach air line to chassis with plastic straps or wire.
- F. Drill 5/16" hole for inflating valves and mount as illustrated (Rubber washer is for outside weather seal, Figure 7).
- G. Connect the air line to the inflation valve.
- H. Repeat process for right side.
- I. Continue with step 4.
4. Install Heat Shield kit. NOTE: Separate instructions are included with the heat shield kits.
5. Inflate Air Springs to 35 p.s.i. Check for air leaks at all fittings and valve core with a soapy water solution).
6. Replace wheels, remove safety stands and carefully lower vehicle to ground. Check to ensure cylinder is properly seated in coil spring.
7. Deflate Air Springs in 5 p.s.i. intervals to determine best ride and handing. Sufficient air pressure should be maintained to help prevent bottoming-out on large bumps, chuck holes, ect
8. Recheck air pressure after 24 hours. A 2-4 p.s.i. loss is normal after initial installation. If the pressure has dropped more than 5 p.s.i. re-test for leaks with a soapy water solution. Please read and follow the Maintenance and Operation Tips on page 4.

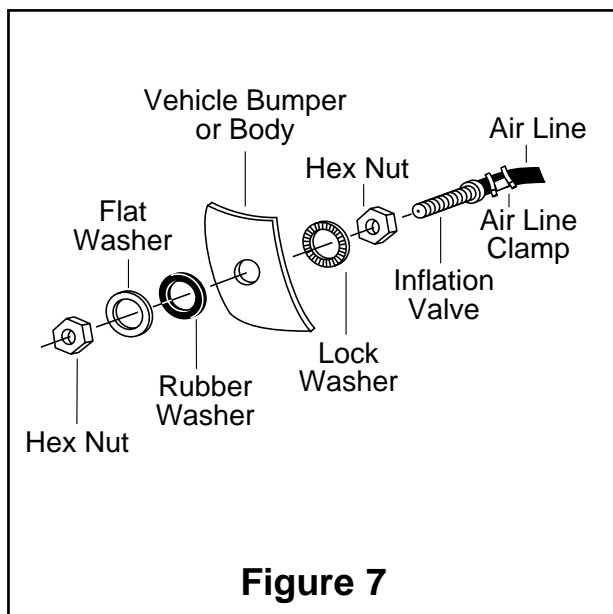

Figure 7

FAILURE TO MAINTAIN MINIMUM PRESSURE WILL VOID THE WARRANTY

| MINIMUM AIR PRESSURE 5 P.S.I. | MAXIMUM AIR PRESSURE 35 P.S.I. |
|--|---|
| <p>MAINTENANCE TIPS:</p> <ol style="list-style-type: none">1. Check pressure weekly!2. Always maintain at least 5 p.s.i. air pressure to prevent chafing or coil pinch.3. If you develop an air leak in the system, use a soapy solution to check all air line connections and the valve core before removing cylinder. <p>OPERATING TIPS:</p> <ol style="list-style-type: none">1. Inflate your air springs to 35 p.s.i. before adding the payload. After vehicle is loaded, adjust your air pressure (down) to level the vehicle and for ride comfort.2. When you are carrying a payload it will be helpful to increase the tire inflation pressure in proportion to any overload condition. We recommend a 2 p.s.i. increase above normal (not to exceed tire manufacturers maximum) for each 100 lbs.additional load on the axle. | |
|  | <p><i>Thank you for purchasing Air Lift Products</i></p> <p>AIR LIFT COMPANY P.O. BOX 80167 Lansing, MI 48908-0167</p> |
| <p>FOR TECHNICAL ASSISTANCE CALL 1-800-248-0892</p> | |
| <p>Caution: DO NOT EXCEED THE VEHICLE MANUFACTURERS MAXIMUM GROSS VEHICLE WEIGHT RATING.</p> | |



Product Use Information

Frequently asked questions

Q. Will installing air springs increase the weight ratings of a vehicle?

No. Adding air springs will not change the weight ratings (GAWR, GCWR and/or GVWR) of a vehicle. Exceeding the GVWR is dangerous and voids the Air Lift warranty.

Q. Is it necessary to keep air in the air springs at all time and how much pressure will they need?

The minimum air pressure should be maintained at all times. The minimum air pressure keeps the air spring in shape, ensuring that it will move throughout its travel without rubbing or wearing on itself.

Q. Is it necessary to add a compressor system to the air springs?

No. Air pressure can be adjusted with any type of compressor as long as it can produce sufficient pressure to service the springs. Even a bicycle tire pump can be used, but it's a lot of work.

Q. How long should air springs last?

If the air springs are properly installed and maintained they can last indefinitely.

Q. Will raising the vehicle on a hoist for service work damage the air springs?

No. The vehicle can be lifted on a hoist for short-term service work such as tire rotation or oil changes. However, if the vehicle will be on the hoist for a prolonged period of time, support the axle with jack stands in order to take the tension off of the air springs.

Tuning the air pressure

Pressure determination comes down to three things — level vehicle, ride comfort, and stability.

1. Level vehicle

If the vehicle's headlights are shining into the trees or the vehicle is leaning to one side, then it is not level (fig. 1). Raise the air pressure to correct either of these problems and level the vehicle.

2. Ride comfort

If the vehicle has a rough and harsh ride it may be due to either too much pressure or not enough (fig. 2). Try different pressures to determine the best ride comfort.

3. Stability

Stability translates into safety and should be the priority, meaning the driver may need to sacrifice a perfectly level and comfortable ride. Stability issues include roll control, bounce, dive during braking and sponginess (fig. 3). Tuning out these problems usually requires an increase in pressure.

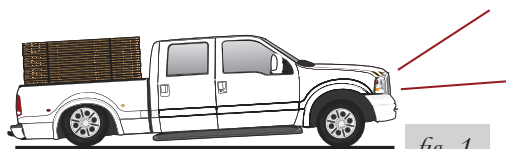

Bad headlight aim



Sway and body roll



Rough ride

Guidelines for adding air:

1. Start with the vehicle level or slightly above.
2. When in doubt, always add air.
3. For motorhomes, start with 50-100 PSI in the rear because it can be safely assumed that it is heavily loaded.
4. If the front of the vehicle dives while braking, increase the pressure in the front air bags, if equipped.
5. If it is ever suspected that the air bags have bottomed out, increase the pressure (fig. 4).
6. Adjust the pressure up and down to find the best ride.
7. If the vehicle rocks and rolls, adjust the air pressure to reduce movement.
8. It may be necessary to maintain different pressures on each side of the vehicle. Loads such as water, fuel, and appliances will cause the vehicle to be heavier on one side (fig. 5). As much as a 50 PSI difference is not uncommon.

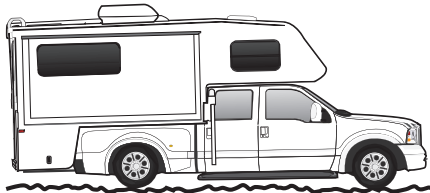

Bottoming out

fig. 4

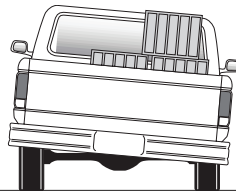

Unlevel

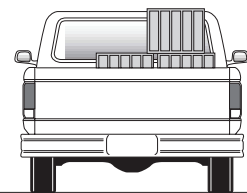

Level

fig. 5

Warranty and Returns Policy

Air Lift Company warrants its products, for the time periods listed below, to the original retail purchaser against manufacturing defects when used on catalog-listed applications on cars, vans, light trucks and motorhomes under normal operating conditions for as long as Air Lift manufactures the product. The warranty does not apply to products that have been improperly applied, improperly installed, used in racing or off-road applications, used for commercial purposes, or which have not been maintained in accordance with installation instructions furnished with all products. The consumer will be responsible for removing (labor charges) the defective product from the vehicle and returning it, transportation costs prepaid, to the dealer from which it was purchased or to Air Lift Company for verification.

Air Lift will repair or replace, at its option, defective products or components. A minimum \$10.00 shipping and handling charge will apply to all warranty claims. Before returning any defective product, you must call Air Lift at (800) 248-0892 in the U.S. and Canada (elsewhere, (517) 322-2144) for a Returned Materials Authorization (RMA) number. Returns to Air Lift can be sent to: Air Lift Company • 2727 Snow Road • Lansing, MI • 48917.

Product failures resulting from abnormal use or misuse are excluded from this warranty. The loss of use of the product, loss of time, inconvenience, commercial loss or consequential damages is not covered. The consumer is responsible for installation/reinstallation (labor charges) of the product. Air Lift Company reserves the right to change the design of any product without assuming any obligation to modify any product previously manufactured.

This warranty gives you specific legal rights and you may also have other rights that vary from state-to-state. Some states do not allow limitations on how long an implied warranty lasts or allow the exclusion or limitation of incidental or consequential damages. The above limitation or exclusion may not apply to you. There are no warranties, expressed or implied including any implied warranties of merchantability and fitness, which extend beyond this warranty period. There are no warranties that extend beyond the description on the face hereof. Seller disclaims the implied warranty of merchantability. (Dated proof of purchase required.)

| | |
|---------------------------------|-------------------------|
| Air Lift 1000 | Lifetime Limited |
| RideControl | Lifetime Limited |
| SlamAir | Lifetime Limited |
| LoadLifter 5000* | Lifetime Limited |
| EasyStreet Systems | 1 Year Limited |

| | |
|-----------------------------------|-----------------------|
| Load Controller (I) | 2 Year Limited |
| Load Controller (II) | 2 Year Limited |
| SmartAir | 2 Year Limited |
| Wireless AIR | 2 Year Limited |
| Other Accessories | 2 Year Limited |

**formerly SuperDuty*

Thank you for purchasing Air Lift products! For technical support, please call (800) 248-0892.
 Air Lift Company • P.O. Box 80167, MI 48908-0167 • (517) 322-2144 • Fax: (517) 322-0240 • www.airliftcompany.com