

Figure 1

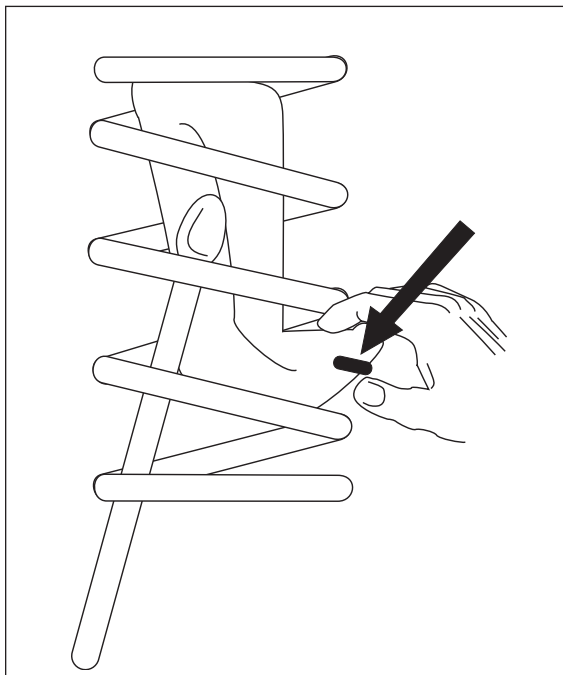

Figure 2

I. Installing the Air Cylinder

1. Jack up rear of vehicle or raise on hoist. Support frame with safety stands. Lower axle or raise body of vehicle until suspension is fully extended.
2. Pry the stock jounce bumper out of the jounce bumper bracket and discard (Figure 1).
3. Remove the upper jounce bumper retainer bracket by removing the bolt holding it in place (Figure 1). These parts will not be reused.
4. Remove the plastic cap from the barbed stem on the end of the air cylinder and exhaust all the air from the cylinder by rolling it up towards the barbed stem. Replace the cap so that the cylinder holds its flat shape. Form the cylinder into a hot dog bun shape. If necessary, use string, tape, or wire to retain this shape.
5. Insert the formed cylinder into the lower coil spring seat opening with the barbed stem to the bottom (Figure 2).
6. Push the cylinder into the coil spring by hand or carefully with a blunt object such as a spoon type tire iron.
7. When the air cylinder is completely within the coil, remove the cap and allow it to assume its original shape.

II. Creating the Spring Seat Hole

It will be necessary to drill a 3/4" hole for hose access to the stem on the bottom spring seat.

1. Raise one side at a time and mark where the stem touches the lower spring seat. The hole will need to be drilled on the other side of the control arm. Note the area previously marked and duplicate on the other side of the control arm.
2. With the suspension hanging, mark, center punch, and drill a 1/8" hole through the bottom of the spring seat. CAUTION: Do not drill a hole through the bottom of the cylinder.
3. Note the location drilled and adjust with a new hole, if necessary. Using the previous hole drilled, enlarge the hole to a 3/4" hole to obtain proper valve stem clearance.
4. Lift the suspension up all the way so that the cylinder contacts the bottom of the spring seat. The stem cannot touch the sides of the lower control arm. If necessary, grind for clearance.
5. Remove all burrs on the cylinder side of the control arm.

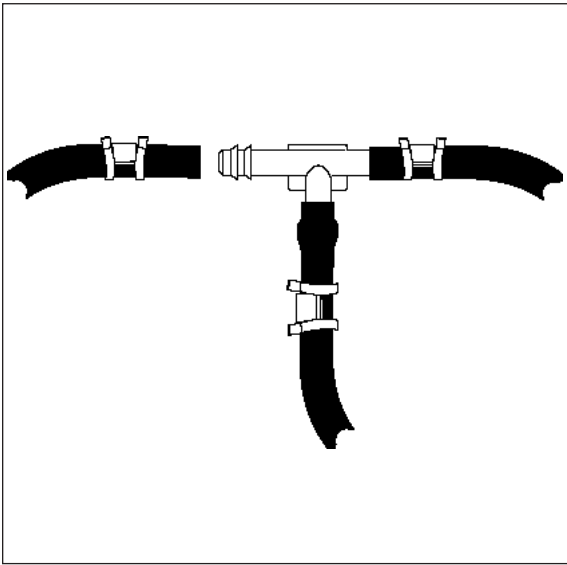

Figure 3

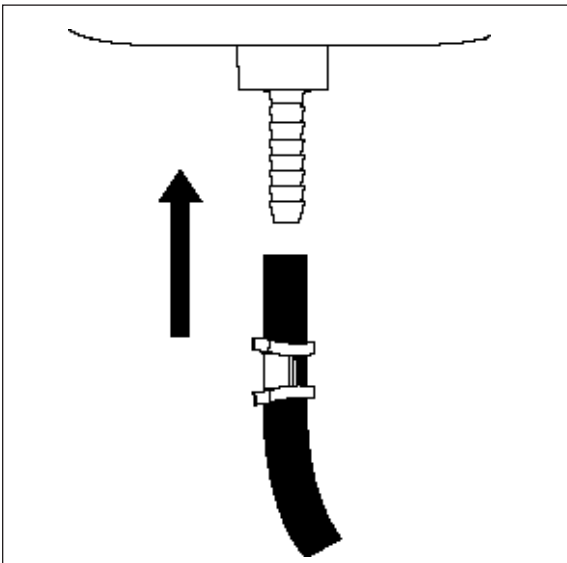

Figure 4

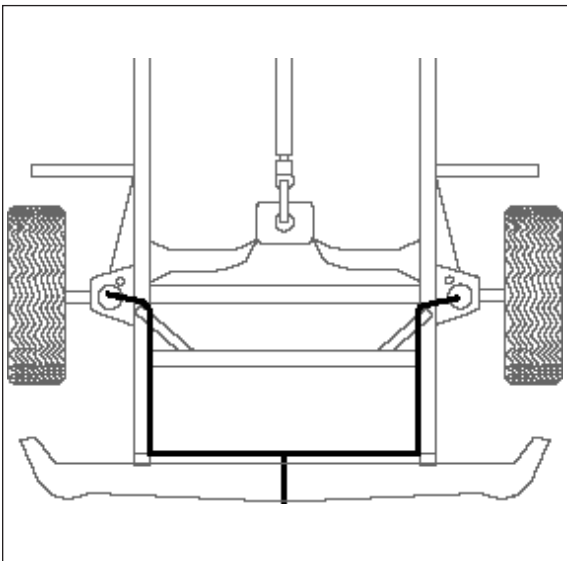

Figure 5

III. Installing the Air Line

Air tee line installation is recommended unless weight in vehicle varies from one side to the other and unequal pressures are needed to level the load. Dual air lines are used in this case.

1. Tee Air Line routing:

IMPORTANT: To prevent air line from melting, keep it at least 8" from the exhaust system.

- a. Locate desired tee location on the frame rail or cross member.
- b. Determine and cut adequate length of air line to reach from tee to left and right side on air cylinders. **CAUTION: Leave sufficient air line slack to prevent any strain on fitting during axle motions.**
- c. Slide air line clamp onto the air line.
- d. Push the air line over one side of the tee until all the barbs are covered. Repeat procedure for other leg of tee (Figure 3).
- e. With pliers slide the air line clamp forward until it fully covers the barbed section. Repeat for other leg of tee (Figure 3).
- f. Route along cross member and lower control to air cylinder.
- g. Insert air line through lower control arm.
- h. Push the air line onto the stem of the air spring, covering all the barbs (Figure 4).
- i. With pliers slide the air line clamp upward until it fully covers the barbed section.
- j. Push the remaining air line over the last fitting on tee and route along frame to desired inflation valve location (Figure 5). Attach with plastic straps or wire.
- k. Select a location for inflation valve in the gas cap well, the truck, rear bumper, fender flange or behind the license plate, insuring that the valve will be protected and accessible with an air hose.
- l. Drill a $\frac{5}{16}$ " hole for inflation valve and mount as in illustration (Figure 6). Rubber washer is for outside weather seal.
- m. Slide air line clamp over the air line. Push air line onto fitting covering all barbs, with pliers slide the air line clamp forward until it fully covers the barbed section (Figure 7).
- n. Raise axle or lower body until air cylinders lightly touch upper spring seat and lower spacers.
- o. **CAUTION: Do not inflate air cylinders before reading Inflating the Air Springs section.**
- p. Continue with Section IV.

2. Dual Air Line routing:

IMPORTANT: To prevent air line from melting, keep it at least 8" from the exhaust system.

- a. Select a location for the inflation valves in the rocker panel flange, or rear bumper, insuring that each valve will be protected and accessible with an air hose (Figure 8).
- b. Determine and cut adequate length of air line to reach from valve location to left side air cylinder. **CAUTION: Leave sufficient air line slack to prevent any strain on valve stem during axle motions.**
- c. Insert the air line through the lower control arm and spacer.
- d. Slide air line clamp onto the cut air line.
- e. Push the air line onto the stem of the air spring, covering all the barbed section (Figure 4).
- f. With pliers slide the air line clamp forward until it fully covers barbed section (Figure 4).
- g. Repeat process for right side.
- h. Drill $\frac{5}{16}$ " hole for inflating valves and mount as illustrated. Rubber washer is for outside weather seal (Figure 6).
- i. Route air line along control arm and frame to inflation valve location and cut off excess.
- j. Slide a clamp onto the air line and push the air line over the fitting, covering all the barbs.
- k. With pliers slide the air line clamp forward until it fully covers the barbed section.
- l. Raise axle or lower body until air cylinders lightly touch upper spring seat and lower spacers.
- m. **CAUTION: Do not inflate air cylinders before reading Inflating the Air Springs section.**
- n. Continue with Section IV.

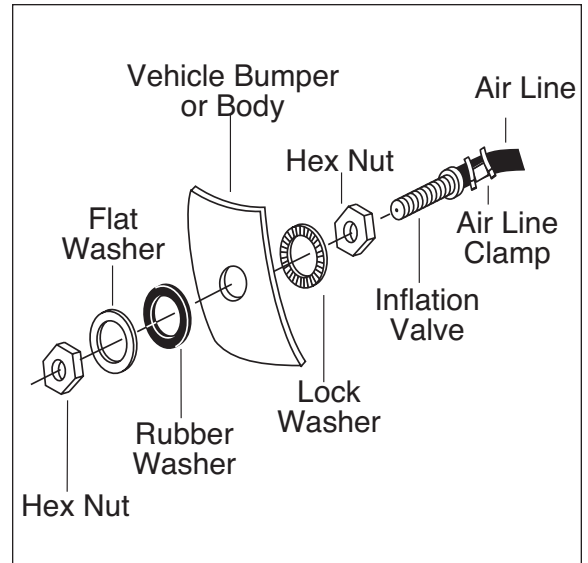

Figure 6

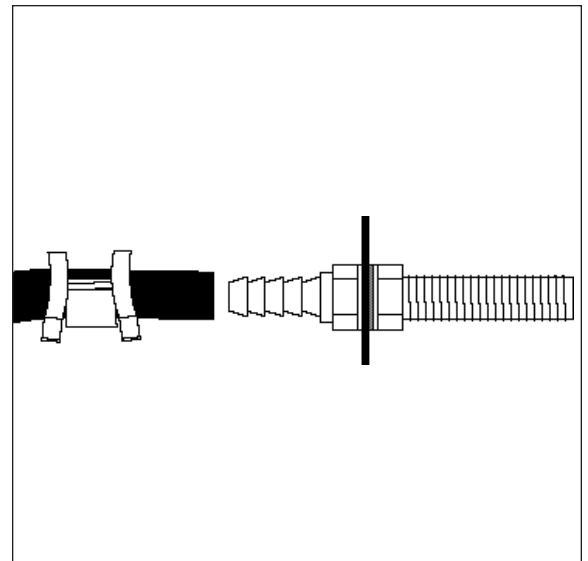

Figure 7

IV. Testing the Air Springs

1. Inflate the cylinders to 25 lbs of air pressure. Test for air leaks by applying a liquid solution of $\frac{1}{5}$ dish soap to $\frac{4}{5}$ water to all valve cores, fittings, and connections.
2. Lower the vehicle to the ground and deflate the air springs in 5 p.s.i. intervals to determine best ride and handling.
3. Recheck air pressure after 24 hours. A 2-4 p.s.i. loss after initial installation is normal. If pressure has dropped by more than 5 lbs, then retest for leaks with the soapy water solution.

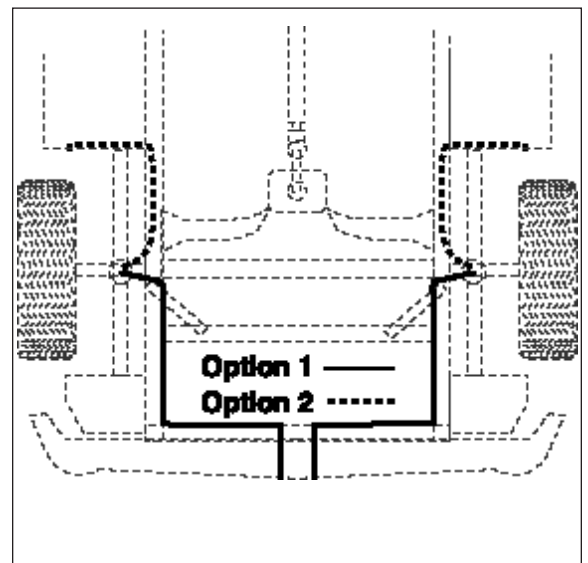

Figure 8

V. Inflating the Air Springs

1. Inflate the air springs to 20 p.s.i. before adding the payload.
2. After vehicle is loaded, adjust the air pressure down to level the vehicle for ride comfort.

VI. Maintenance

1. Check air pressure weekly.
2. Always maintain at least a 5 p.s.i. air pressure chafing or coil pinch.
3. If a leak develops in the system, use a soapy water solution to check all air line connections and valve cores before removing the cylinder.

Minimum Air Pressure	Maximum Air Pressure
5 p.s.i.	25 p.s.i.

Failure to maintain minimum pressure will void the warranty.



Thank you for purchasing Air Lift Products

Mailing Address:
AIR LIFT COMPANY
P.O. Box 80167
Lansing, MI 48908-0167

Street Address:
AIR LIFT COMPANY
2710 Snow Rd.
Lansing, MI 48917

Local Phone: (517) 322-2144
Fax: (517) 322-0240

For Technical Assistance call 1-800-248-0892, extension 2

“The Choice of the Professional Installer”

Printed in the USA