



LoadLifter 5000™

S E R I E S

Installation
Guide



GM Silverado/Sierra 1500

Kits 57288 | 88288 | 89288

GM Trail Boss/Sierra AT4

Kits 57388 | 88388 | 89388

For maximum effectiveness and safety, please read these instructions completely before proceeding with installation.

IDENTIFYING THE DIFFERENCES BETWEEN KITS

Should you need to contact Air Lift customer service, you will need to know which kit you are inquiring about: standard LoadLifter 5000, LoadLifter 5000 Ultimate or LoadLifter 5000 Ultimate Plus. The kits are easily identifiable by looking at the roll plates and air lines.

- Standard **LoadLifter 5000** — Zinc-plated steel roll plates and black nylon air lines.
- LoadLifter 5000 Ultimate** — Black powder-coated roll plates and black nylon air lines.
- LoadLifter 5000 Ultimate Plus** — Stainless steel roll plates, braided stainless steel air lines, stainless steel air spring mounting hardware.



LoadLifter 5000
silver zinc-plated steel
roll plate



LoadLifter 5000 Ultimate
black powder-coated
roll plate



LoadLifter 5000 Ultimate Plus
stainless steel
roll plate



LoadLifter 5000
nylon air line



LoadLifter 5000 Ultimate
nylon air line



LoadLifter 5000 Ultimate PLUS
braided stainless steel air line

Air Lift offers two Ultimate Plus upgrade kits:

52300 - Braided stainless steel air line and fittings.

52301 - Stainless steel roll plates, air spring mounting hardware, braided stainless steel air lines and fittings.

TABLE OF CONTENTS

A. Installation Diagram	2
B. Hardware and Tools Lists	3
C. Introduction	4
Notation Explanation	4
D. Installing the LoadLifter 5000 Series System	5
Getting Started	5
Assembling the Air Springs	7
Installing the Air Springs	8
Attaching the Upper Brackets	9
E. Installing the Air Lines	10
Installing Nylon Air Lines	11
Installing Braided Stainless Steel Air Lines	11
F. Finished Installation	12
Installation Checklist	13
Maintenance and Use Guidelines	13
Minimum and Maximum Air Pressure	13
Limited Warranty and Return Policy	13

A. Installation Diagram

NOTE: If the truck has fifth-wheel hitch brackets along the side of the frame, these U-bolts may not be used.

* Optional hardware for vehicles equipped with fifth-wheel hitches that have frame side plates (see page 9 for details)

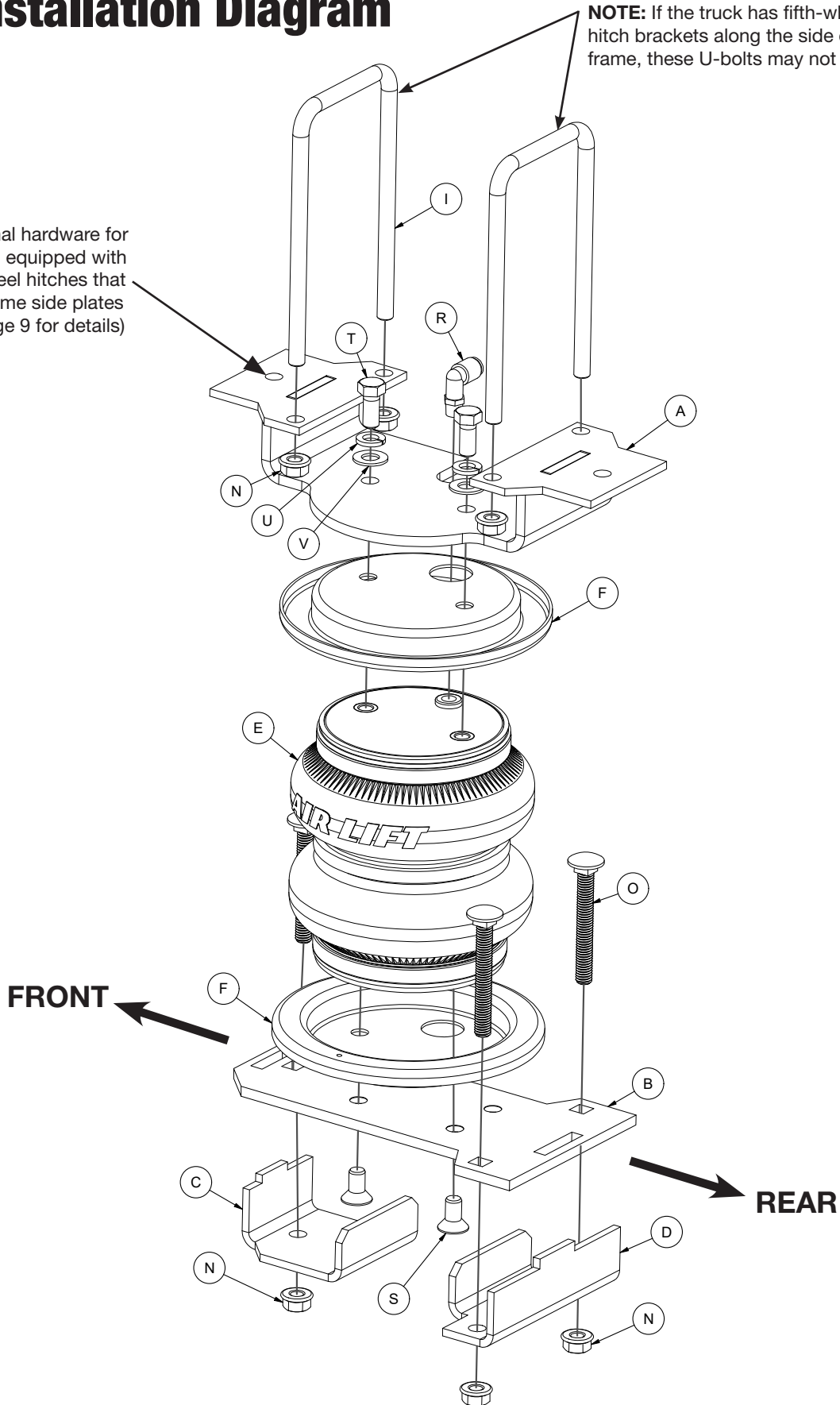

fig. A.1

B. Hardware and Tools Lists

Common Parts Included in All 3 Kits

Item	Part#	Description	Qty
A	07856	Upper bracket (GM 1500)	2
A	07388	Upper bracket (Trail Boss/Sierra AT4)	2
B	03156	Lower bracket	2
C	01656	Forward clamp bracket	2
D	01646	Rear clamp bracket	2
G*	01615	Brake line tab bracket	2
H*	13964	Spacer	2
I	11456	U-bolt 3/8"-16 x 6 1/2"	4
J*	17496	M8 -1.5 x 20 Hex head cap screw	2
K*	17414	M8 -1.25 x 50 Hex head cap screw	2
L*	18501	M8 Stainless steel flat washer	4
M*	18522	M8 x 1.25 Nylon lock nut	2
N	18422	3/8"-16 Serrated flange lock nut	14
O	17277	3/8"-16 x 3" Carriage bolt	6
P*	17129	3/8" x 1" Thread cutting screw	4
W*	10466	Zip ties	6
X*	18411	5/16" Lock washer	2

* These parts are not shown in the Installation Diagram (Fig. A.1).

Unique Parts in Each Kit

LoadLifter 5000™ KIT 57288 & 57388

Item	Part#	Description	Qty
E	58439	Air spring (GM 1500)	2
E	58496	Air spring ext (Trail Boss/Sierra AT4)	2
F*	11951	Roll plate (silver zinc plated)	4
Q	20086	Air line assembly	1
R	21837	90 degree Swivel elbow fitting	2
S	17215	3/8"-24 x 3/4" Flat head socket cap screw	4
T	17203	3/8"-24 x 7/8" Hex head cap screw	4
U	18427	3/8" Split lock washer	4
V*	18444	3/8" Flat washer	4
Y*	21230	Valve cap	2
Z*	21233	5/16"-32 Hex nut	4
AA*	21234	Rubber washer	2
BB	18501	Flat washer	2

LoadLifter 5000™ ULTIMATE KIT 88288 & 88388

Item	Part#	Description	Qty
E	58494	Air spring w jounce bumper (GM 1500)	2
E	58437	Air spring w jounce bumper (Trail Boss/Sierra AT4)	2
F*	11967	Roll plate (black powder coated)	4
Q	20086	Air line assembly	1
R	21837	90 degree Swivel elbow fitting	2
S	17215	3/8"-24 x 3/4" Flat head socket cap screw	4
T	17203	3/8"-24 x 7/8" Hex head cap screw	4
U	18427	3/8" Split lock washer	4
V*	18444	3/8" Flat washer	4
Y*	21230	Valve cap	2
Z*	21233	5/16"-32 Hex nut	4
AA*	21234	Rubber washer	2
BB	18501	Flat washer	2

TOOLS LIST

Description	Qty
Standard and metric open-end or box wrenches	2
Adjustable wrench	1
Ratchet with 10mm & 9/16" deep-well sockets	1
3/8" Nut driver	1
T40 Torx bit	1
Torque wrench	1
Standard and metric hex head wrenches	1
Hose cutter, razor blade, or sharp knife	1
Hoist or floor jacks	1
Safety stands	1
Safety glasses	1
Air compressor or compressed air source	1
Spray bottle with dish soap/water solution	1

The photos in this manual show the LoadLifter 5000 kit.

LoadLifter 5000™ ULTIMATE PLUS+ KIT 89288 & 89388

Item	Part#	Description	Qty
E	58494	Air spring w jounce bumper	2
E	58437	Air spring w jounce bumper (Trail Boss/Sierra AT4)	2
F*	11880	Roll plate (stainless steel)	4
CC*	20987	Stainless steel braided air line	2
Q	20084	Air line assembly	1
R	21815	AN-type fitting	2
S	17363	3/8" - 24 x 3/4" Flat head socket cap screw ss	4
T	17284	3/8" - 24 x 7/8" Hex head cap screw ss	4
U	18504	3/8" Split lock washer ss	4
V*	18507	3/8" Flat washer ss	4
AA*	21234	Rubber washer	2
BB*	18501	M8 Flat washer	2
CC*	21709	Schrader valve with cap & nut	2
DD	21813	AN to PTC fitting	2



Missing or damaged parts? Call Air Lift customer service at (800) 248-0892 for a replacement part.

C. Introduction

The purpose of this publication is to assist with the installation and maintenance of the LoadLifter 5000 series air spring kits. All LoadLifter 5000 series kits utilize sturdy, reinforced, commercial-grade single or double, depending on the kit, convolute bellows.

The air springs are manufactured like a tire with layers of rubber and cords that control growth. LoadLifter 5000 kits provide up to 5,000 pounds (2,268kg) of load-leveling support with air adjustability from 5-100 PSI (.34-7BAR).

It is important to read and understand the entire installation guide before beginning installation or performing any maintenance, service or repair.

NOTATION EXPLANATION

Hazard notations appear in various locations in this publication. Information which is highlighted by one of these notations must be observed to help minimize risk of personal injury or possible improper installation which may render the vehicle unsafe. Notes are used to help emphasize areas of procedural importance and provide helpful suggestions. The following definitions explain the use of these notations as they appear throughout this guide.



INDICATES IMMEDIATE HAZARDS WHICH WILL RESULT IN SEVERE PERSONAL INJURY OR DEATH.



INDICATES HAZARDS OR UNSAFE PRACTICES WHICH COULD RESULT IN SEVERE PERSONAL INJURY OR DEATH.



INDICATES HAZARDS OR UNSAFE PRACTICES WHICH COULD RESULT IN DAMAGE TO THE MACHINE OR MINOR PERSONAL INJURY.

D. Installing the LoadLifter 5000 Series System

GETTING STARTED

1. Raise and support the vehicle in a way, using safety stands or equivalent, that the axle can be safely dropped away from the frame. This will need to be done for the air spring assembly to be put into position between the axles and frame (Fig. D.1).

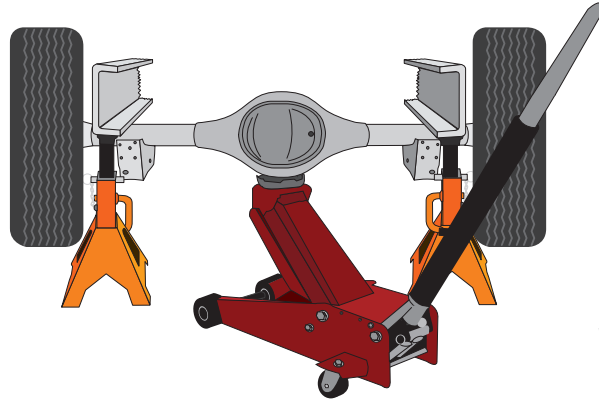

fig. D.1

2. Remove the factory bolts that hold the upper brake line bracket in place. Reattach the bracket using the two new M8-1.25 x 50 hex head cap screws (K), two new M8 flat washers (L), and two new spacers (H) (Figs. D.2 & D.3). Torque bolts to 10 lb.-ft. (14Nm).



fig. D.2

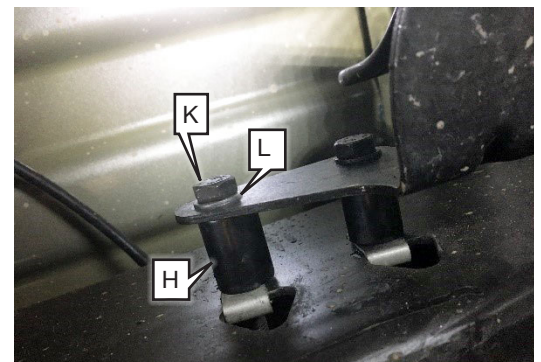

fig. D.3

3. Locate the jounce bumpers. Using a 10mm deep socket, remove the jounce bumpers (both sides) and discard (Figs. D.4 & D.5).

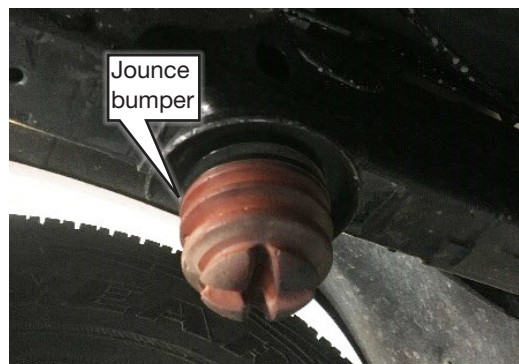

fig. D.4

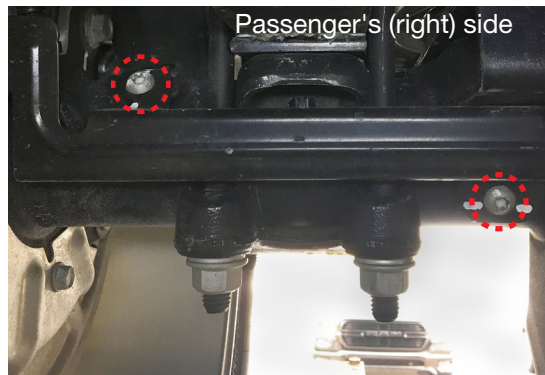

fig. D.5

- For Trail Boss/Sierra AT4 models, unfasten 4 bolts and remove spacer (Fig. D.6).

fig. D.6

- Using a T40 sized Torx bit, remove the two outer most Torx head screws on both wire harness guards, located on the front side of the axle (Fig D.7).

fig. D.7

- Remove the brake line bracket attached to the axle under the leaf spring on both sides of the vehicle. Set bolt aside for reinstallation.
- Attach the brake line tab bracket (G) using the factory hardware previously removed and tighten securely on both sides of the vehicle (Figs. D.8 & D.9).
- Attach the brake line bracket to the brake line tab bracket using M8 hardware (J, L & M) on both sides of the vehicle (Fig. D.9). Torque bolts to 16 lb.-ft. (22Nm).

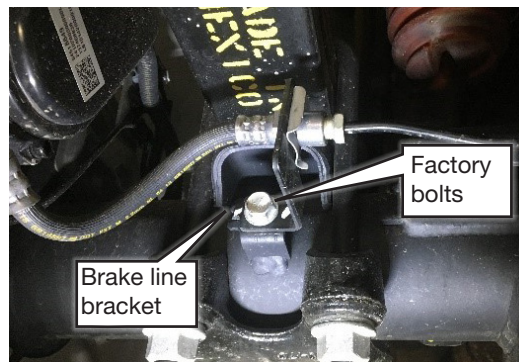
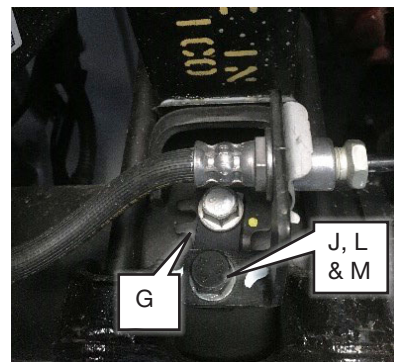
fig. D.8

fig. D.9

- Position the forward clamp bracket (C) on the front side of the axle (Figs. D.10 & D.11).



fig. D.10



Ensure the two Torx head screws on both wire harness guards were removed (see Step 5)

fig. D.11

ASSEMBLING THE AIR SPRINGS

- Place a 3/8"-16 x 3" carriage bolt (O) through the innermost square hole on the rear side of each lower bracket (B) (Fig. D.12).

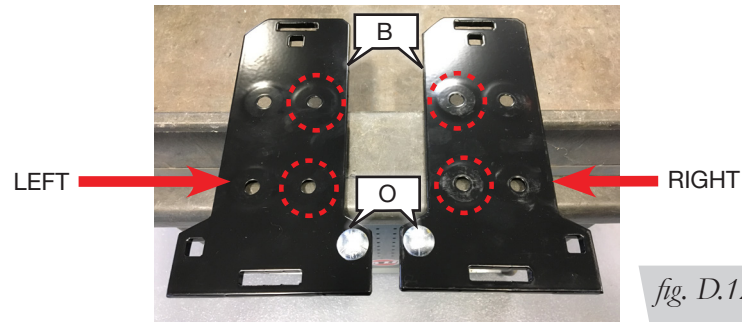

fig. D.12

NOTE

The radiused (rounded) edge of the roll plate (F) will be toward the air spring so that the air spring is seated inside the roll plate.

- Install a lower bracket (B) and roll plate (F) on each air spring (E) using two 3/8"-24 x 3/4" flat head socket cap screws (S) through the innermost mounting holes (Fig. D.13). Torque the flathead screws to no more than 20 lb.-ft. (27Nm) (Fig. D.13).
- Install the 90 degree swivel elbow fitting (R) into the top of each air spring finger tight. Tighten the swivel fittings an additional one and a half turns (Fig. D.13).

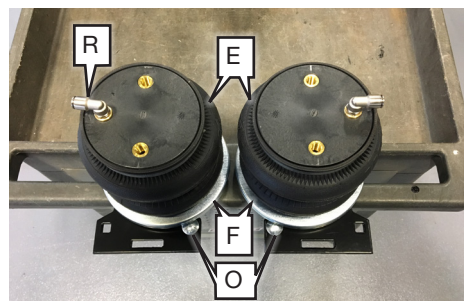

fig. D.13

- Attach the upper roll plates (F) and upper brackets (A) to the air springs (E) using two 3/8"-24 x 7/8" bolts (T), two 3/8" lock washers (U) and two 3/8" flat washers (V) for each assembly (Fig. D.14). Torque bolts to no more than 20 lb.-ft. (27Nm). These brackets are left and right hand specific (Fig. D.15).

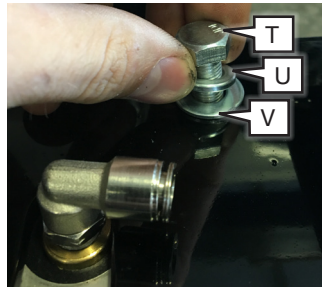
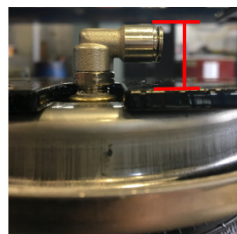

fig. D.14

fig. D.15

- With the bracket installed, ensure the swivel fitting is less than 7/8" in height, and if not, tighten the fitting until this height is achieved (Fig. D.16).



Ensure fitting is less than 7/8" in height

fig. D.16

INSTALLING THE AIR SPRINGS



CAUTION

- Drop the frame to make room to put the assemblies into position. ENSURE VEHICLE IS PROPERLY SUPPORTED PRIOR TO BEGINNING INSTALLATION.
- Place the assemblies on the lower strike plate with the fitting side of the assembly to the outside (wheel side) of the vehicle. Align the tab on the forward clamp bracket (C) with the hole on the front of the lower bracket (B) (Fig. D.17).
- Insert two carriage bolts (O) on the rear square holes and one carriage bolt on the front square hole of the lower bracket (B) (both sides) (Figs. D.17 & D.18).

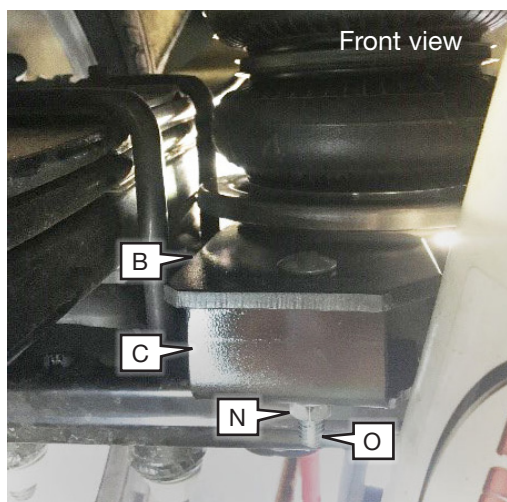
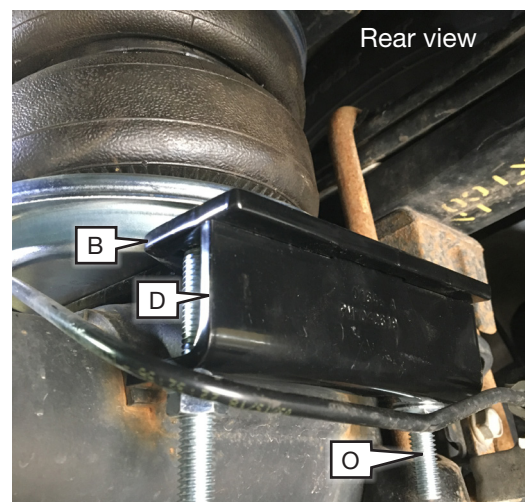
fig. D.17

fig. D.18

4. Thread the 3/8" flange nuts (N) onto the carriage bolts previously installed. Ensure the front and rear clamps align correctly under the axle jounce bumper strike plate. Torque all flange nuts evenly to 16 lb.-ft. (22Nm).

ATTACHING THE UPPER BRACKETS

There are two ways to attach the upper bracket.

For trucks that do not have a fifth-wheel hitch bracket alongside the frame:

1. Place U-bolts (I) over the frame as pictured on both sides of the vehicle (Fig. D.19).

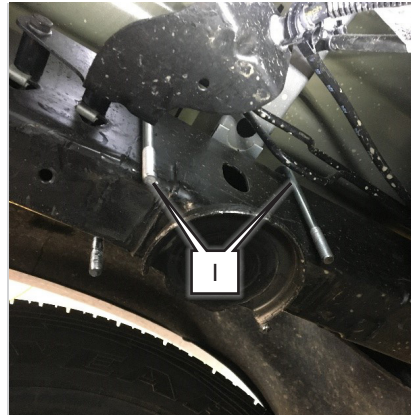

fig. D.19

2. Lower the vehicle or raise the axle while inserting the threaded portions of the U-bolts (I) through the corresponding holes in the upper brackets (A). Install flange nuts (N) finger tight (Fig. D.20).

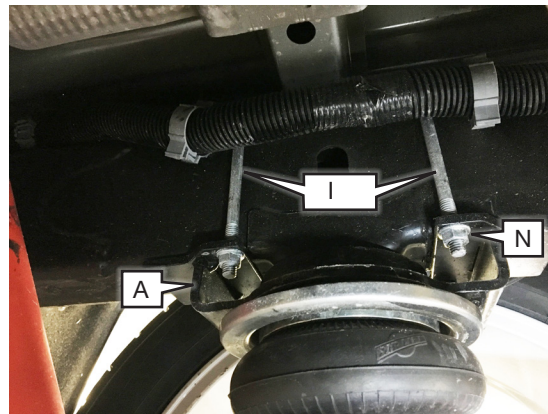

fig. D.20

3. Adjust the upper bracket (A) as needed to vertically align the air spring with the frame (or as close to perpendicular as possible).
4. Torque all flange nuts (N) to 16 lb.-ft. (27Nm).

For trucks that have fifth-wheel hitch brackets alongside the frame rail:

1. There are holes in the middle of the bracket just forward and behind the jounce bumper mounting cups on the upper bracket (Fig. A.1). Once the upper brackets are in position, drill two 5/16" holes through the bottom of the frame using the holes as a template and attach the upper brackets using the thread cutting screws (P). Torque all four fasteners to 15 lb.-ft. (20Nm).

2. Reattach the wire harness guards on the front side of the axle. Tighten securely (Fig. D.21).

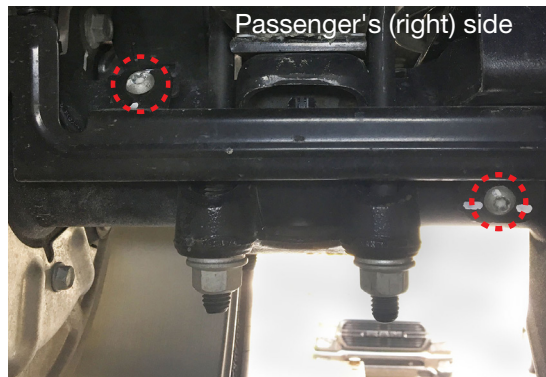
fig. D.21

E. Installing the Air Lines

Air lines are routed from the air springs to Schrader valves. LoadLifter 5000 series air lines come in two styles: nylon and braided stainless steel. Begin by choosing locations for the Schrader valves and drill a 5/16" (8mm) hole, if necessary (Fig. E.1).

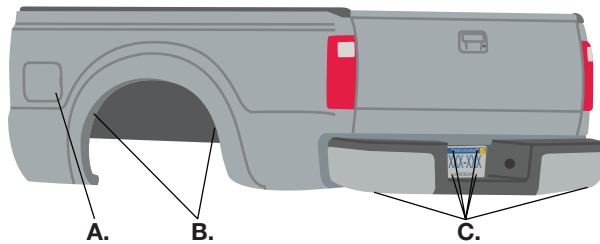

- A. Inside fuel tank filler door
- B. Inside rear wheel wells
- C. License plate or rear bumper area*

* For LoadLifter 5000 Ultimate Plus kits, the recommended location for the Schrader valves is the rear bumper area or license plate.

fig. E.1

KEEP AT LEAST 6" (150MM) OF CLEARANCE BETWEEN ALL AIR LINES AND THE EXHAUST SYSTEM. AVOID SHARP BENDS AND EDGES.

INSTALLING NYLON AIR LINES

1. Cut the air line in half. Make clean, square cuts with a razor blade or hose cutter (Fig. E.2). Do not use scissors or wire cutters.

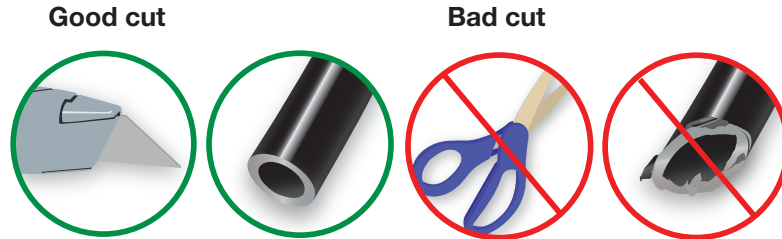

fig. E.2

2. Use zip ties to secure the air line to fixed points along the chassis. Do not pinch or kink the air line. The minimum bend radius for the air line is 1" (25mm). Leave at least 2" (50mm) of slack in the air line to allow for any movement that might pull on the air line.
3. Install the Schrader valve in the chosen location (Fig. E.3).

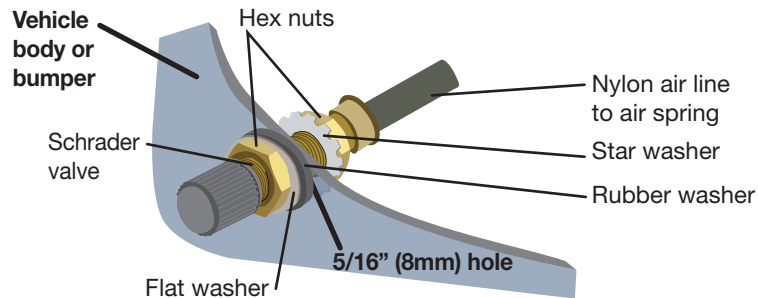

fig. E.3

INSTALLING BRAIDED STAINLESS STEEL AIR LINES



CAUTION

KEEP THE AIR LINE AWAY FROM THE FUEL LINE, BRAKE LINES AND ELECTRICAL WIRES.

1. Use zip ties to secure the air line to fixed points along the chassis every 6" to 8" (150-200mm). Leave at least 2" (50mm) of slack to allow for any movement that might pull on the air line.
2. Tighten the air line hex nut finger tight, then use 2 wrenches to turn 1 additional flat (1/6 of one full turn). **Do not overtighten** (Figs. E.4 or E.5). The easiest way to tighten the fitting is off the vehicle. Install the Schrader valve in the chosen location.
3. Coil and secure any excess air line in an area where it will not be susceptible to damage. The braided stainless steel air line cannot be trimmed.

Air Line Setup Without Compressor System

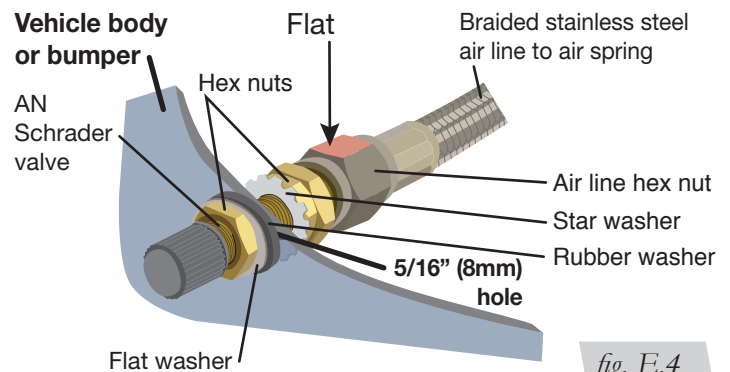

fig. E.4

Air Line Setup for Compressor Integration

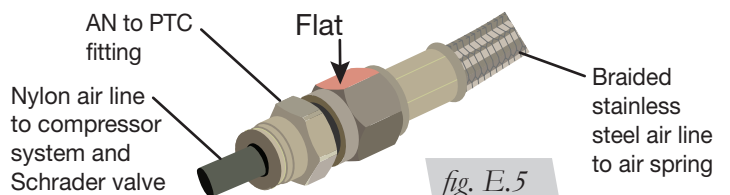

fig. E.5

F. Finished Installation

1. The images show the finished installation of both sides (Figs. F.1, F.2, F.3 & F.4).

NOTE

Finished installation images show the LoadLifter 5000 Ultimate Plus kit installed.

Driver's (left)
side rear
view.



fig. F.1

Passenger's
(right) side
front view.



fig. F.2

Driver's (left)
side front
view.



fig. F.3

Passenger's
(right) side
rear view.



fig. F.4

INSTALLATION CHECKLIST

- Clearance test** — Inflate the air springs to 40-60 PSI (2.8-4.1BAR) and make sure there is at least 1/2" (13mm) clearance from anything that might rub against each sleeve. Be sure to check the tire, brakes, frame, shock absorbers and brake cables.
- Leak test before road test** — Inflate the air springs to 40-60 PSI (2.8-4.1BAR) and check all connections for leaks. All leaks must be eliminated before the vehicle is road tested.
- Heat test** — Be sure there is sufficient clearance from heat sources, at least 6" (152mm) for air springs and air lines. If a heat shield was included in the kit, install it. If there is no heat shield, but one is required, call Air Lift customer service at **(800) 248-0892**.
- Fastener test** — Recheck all bolts for proper torque.
- Road test** — The vehicle should be road tested after the preceding tests. Inflate the springs to recommended driving pressures. Drive the vehicle 10 miles (16km) and recheck for clearance, loose fasteners and air leaks.
- Operating instructions** — If professionally installed, the installer should review the operating instructions with the owner. Be sure to provide the owner with all of the paperwork that came with the kit.

Maintenance and Use Guidelines

1. Check air pressure weekly.
2. Always maintain normal ride height. Never inflate beyond 100 PSI (7BAR).
3. If the system develops an air leak, use a soapy water solution to check all air line connections and the inflation valve core before deflating and removing the air spring.

Minimum Recommended Pressure
5 PSI (.34BAR)

Maximum Air Pressure
100 PSI (7BAR)

 **CAUTION**

FOR SAFETY AND TO PREVENT POSSIBLE DAMAGE TO THE VEHICLE, DO NOT EXCEED MAXIMUM GROSS VEHICLE WEIGHT RATING (GVWR) OR PAYLOAD RATING, AS INDICATED BY THE VEHICLE MANUFACTURER.

 **CAUTION**

ALTHOUGH THE AIR SPRINGS ARE RATED AT A MAXIMUM INFLATION PRESSURE OF 100 PSI (7BAR), THE AIR PRESSURE ACTUALLY NEEDED IS DEPENDENT ON LOAD AND GROSS VEHICLE WEIGHT RATING.

Limited Warranty and Return Policy

Air Lift Company provides a limited lifetime warranty to the original purchaser of its load support products, that the products will be free from defects in workmanship and materials when used on cars and trucks as specified by Air Lift Company and under normal operating conditions, subject to the requirements and exclusions set forth in the full Limited Warranty and Return Policy that is available at www.airliftcompany.com/warranty.

For additional warranty information contact Air Lift Company customer service.



Thank you for purchasing Air Lift Products – the Authorized Installer's choice!

Need Help?

**Contact Air Lift Company Customer Service at (800) 248-0892
or email service@airliftcompany.com.**

For calls outside the U.S. or Canada, dial (517) 322-2144.

Air Lift Company • 2727 Snow Road • Lansing, MI 48917 or P.O. Box 80167 • Lansing, MI 48908-0167

Air Lift Company reserves the right to make changes and improvements to its products and publications at any time.
For the latest version of this manual, contact Air Lift Company at (800) 248-0892 or visit airliftcompany.com.

California: ⚠️WARNING: Cancer and Reproductive Harm - www.P65Warnings.ca.gov



Printed in the USA
JJC-0519