

Load **LIFTER** 5000™ **ULTIMATE**

ADJUSTABLE AIR HELPER SPRINGS

TOW AND HAUL WITH SAFETY AND COMFORT™



Kit Number
88395

INSTALLATION GUIDE

For maximum effectiveness and safety, please read these instructions completely before proceeding with installation.

Failure to read these instructions can result in an incorrect installation.

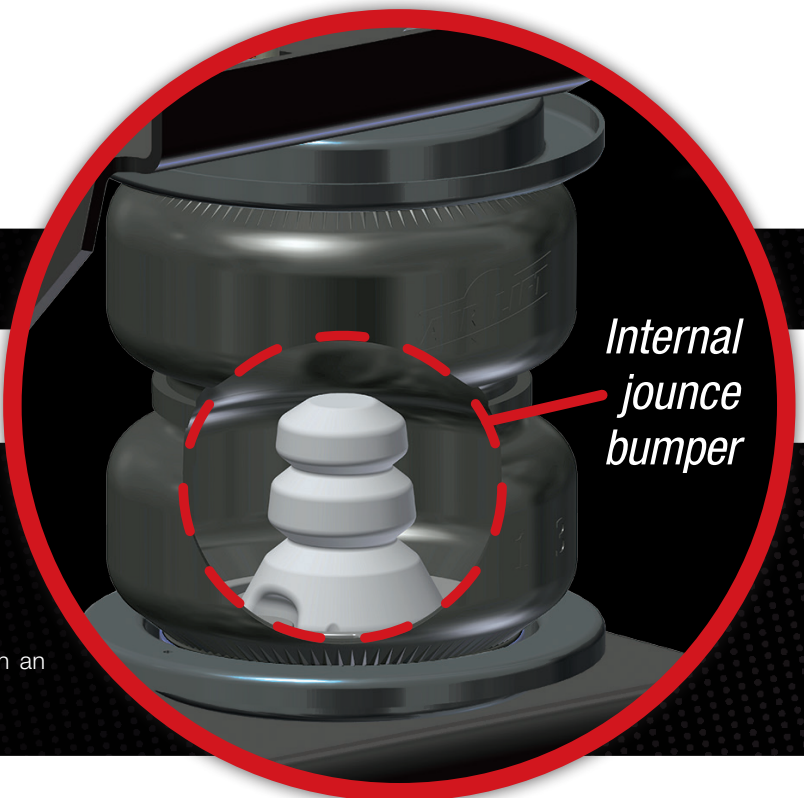

TABLE OF CONTENTS

Installation Diagrams	2
Installation Diagram — Driver’s Side	2
Installation Diagram — Passenger’s Side	2
Hardware and Tools Lists	3
Hardware List	3
Tools List	3
Introduction	4
Important Safety Notice	4
Notation Explanation	4
Installing the LoadLifter 5000 Ultimate System	5
Getting Started	5
Installing the Braces	6
Retaining Clip L-Bracket Installation on Brace	7
Driver’s Side Brace Installation	8
Passenger’s Side Brace Installation	10
Bellows and Bracket Assembly	11
Attaching the Assemblies to the Frame	15
Attaching the Lower Bracket	19
Finishing the Installation	21
Installing the Air Lines	22
Tips for Installing Air Lines	22
Checking for Leaks	24
Fixing Leaks	24
Installing the Heat Shield	24
Finished Installation Photos	25
Before Operating	26
Installation Checklist	26
Post-Installation Checklist	26
Product Use, Maintenance and Servicing	27
Minimum and Maximum Pressure	27
Maintenance Guidelines	27
Troubleshooting Guide	27
Frequently Asked Questions	28
Tuning the Air Pressure	28
Guidelines for Adding Air	29
Limited Warranty and Return Policy	32
How to Get Replacement Parts	33
Contact Information	33

Installation Diagram

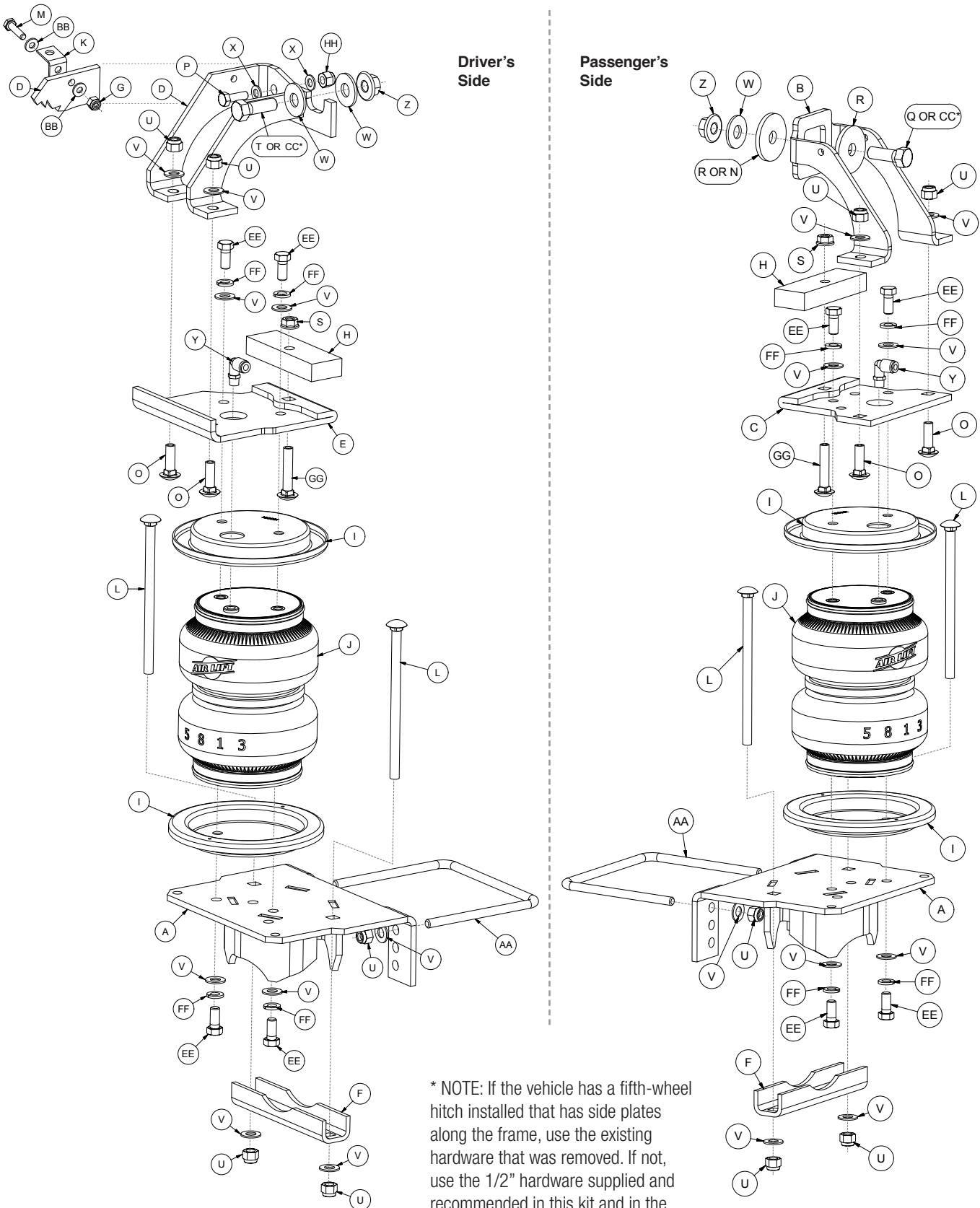

fig. 1

Hardware and Tools Lists

HARDWARE LIST

Item	Part #	Description	Qty
A	03212	Lower Bracket.....	2
B	07996	Upper Brace P.S.	1
C	07997	Upper Bracket P.S.	1
D	07994	Upper Brace D.S.	1
E	07995	Upper Bracket D.S.	1
F	01531	Clamp Bar.....	2
G	18425	1/4"-20 Nylon Lock Nut.....	1
H	13966	Spacer	2
I	11967	Roll Plate	4
J	58496	Bellows	2
K	10886	"L" Bracket.....	1
L	17163	3/8"-16 X 7" Carriage Bolt.....	4
M	17135	1/4"-20 X 1" Hex Cap Screw.....	1
N	18556	3/4" Flat Washer	1
O	17361	3/8"-16 X 1.25" Carriage Bolt.....	4
P	17177	8 mm-1.25" X 25 mm Hex Bolt	1
Q	17161	1/2"-13 X 1.5" Hex Cap Screw.....	1
R	18207	1/2" Thick Flat Washer.....	2
S	18422	3/8"-16 Serrated Flange Lock Nut	2
T	18412	1/2"-13 X 1.25" Hex Cap Screw.....	1
U	18435	3/8"-16 Nylon Lock Nut.....	12
V	18444	3/8" Flat Washer	24
W	18485	1/2" Flat Washer	3
X	18501	M8 Flat Washer	2
Y	21837	90° Swivel Fitting.....	2
Z	18505	1/2"-13 Serrated Flange Lock Nut	2
AA	11717	U-Bolt.....	2
BB	18419	Flat Washer #12	2
CC	17271	1/2"-13 X 3 Hex Cap Screw.....	2
EE	17203	3/8"-24 X 7/8" Hex Cap Screw.....	8
FF	18427	3/8" Lock Washer	8
GG	17140	3/8"-16 X 2" Carriage Bolt.....	2
HH	18522	8 mm X 1.25 Nylon Lock Nut.....	1
II	10465	P-Clamp.....	1
JJ	20086	Air Line Assembly.....	1
KK	10466	Small Zip Ties.....	6
LL	18411	5/16" Lock Washer.....	2
MM	21230	Valve Cap.....	2
NN	21233	5/16" Hex Nut.....	4
OO	21234	Rubber Washer	2
PP	18501	5/16" Flat Washer.....	4
QQ	17103	5/16"-18 X 1" Hex Cap Screw.....	1
RR	18438	5/16"-18 Nylon Lock Nut.....	1
SS	22640	Large Zip Tie.....	1



LoadLifter 5000 unpainted steel roll plate



LoadLifter 5000 Ultimate painted black roll plate



LoadLifter 5000 Ultimate Plus stainless steel roll plate

*** NOTE:** To determine which kit is on your vehicle, look at the roll plates. Unpainted roll plates indicate the standard LoadLifter 5000, black painted roll plates indicates LoadLifter 5000 Ultimate and LoadLifter 5000 Ultimate Plus kits have stainless steel roll plates.



Missing or damaged parts? Call Air Lift customer service at (800) 248-0892 for a replacement part.

Introduction

The purpose of this publication is to assist with the installation, maintenance and troubleshooting of the LoadLifter 5000 Ultimate air spring kit. LoadLifter 5000 Ultimate utilizes sturdy, reinforced, commercial grade single or double, depending on the kit, convolute bellows. The bellows are manufactured like a tire with layers of rubber and cords that control growth. LoadLifter 5000 Ultimate kits are recommended for most 3/4- and 1-ton pickups and SUVs with leaf springs and provide up to 5,000 pounds of load leveling support with air adjustability from 5-100 PSI. The kits are also used in motor home rear applications and some front applications where leaf springs are used.

It is important to read and understand the entire installation guide before beginning installation or performing any maintenance, service or repair. The information here includes a hardware list, tool list, step-by-step installation information, maintenance guidelines and operating tips.

Air Lift Company reserves the right to make changes and improvements to its products and publications at any time. For the latest version of this manual, contact Air Lift Company at (800) 248-0892 or visit airliftcompany.com.

IMPORTANT SAFETY NOTICE

The installation of this kit does not alter the gross vehicle weight rating (GVWR) or payload of the vehicle. Check your vehicle's owner's manual and do not exceed the maximum load listed for your vehicle.

Gross vehicle weight rating: The maximum allowable weight of the fully loaded vehicle (including passengers and cargo). This number — along with other weight limits, as well as tire, rim size and inflation pressure data — is shown on the vehicle's Safety Compliance Certification Label.

Payload: The combined, maximum allowable weight of cargo and passengers that the truck is designed to carry. Payload is GVWR minus the base curb weight.

NOTATION EXPLANATION

Hazard notations appear in various locations in this publication. Information which is highlighted by one of these notations must be observed to help minimize risk of personal injury or possible improper installation which may render the vehicle unsafe. Notes are used to help emphasize areas of procedural importance and provide helpful suggestions. The following definitions explain the use of these notations as they appear throughout this guide.

 **DANGER**

INDICATES IMMEDIATE HAZARDS WHICH WILL RESULT IN SEVERE PERSONAL INJURY OR DEATH.

 **WARNING**

INDICATES HAZARDS OR UNSAFE PRACTICES WHICH COULD RESULT IN SEVERE PERSONAL INJURY OR DEATH.

 **CAUTION**

INDICATES HAZARDS OR UNSAFE PRACTICES WHICH COULD RESULT IN DAMAGE TO THE MACHINE OR MINOR PERSONAL INJURY.

NOTE

Indicates a procedure, practice or hint which is important to highlight.

Installing the LoadLifter 5000 Ultimate System

GETTING STARTED

1. Raise the vehicle and support it in a way, using jack stands or equivalent, that the axle can be safely dropped away from the frame. This will need to be done in order for the air spring assembly to be put into position between the axle and frame (Figs. 1 & 2). Figure 2 shows the frame being supported with the vehicle on a drive-on hoist.



fig. 2

2. Remove the jounce bumpers from under the frame, over the axle. (Figs. 3 & 4)

NOTE

Wire brush the stud on the jounce bumper and use some penetrating oil to help in removal of the jounce bumper. Usually the socket size for the nut is a 15 mm.

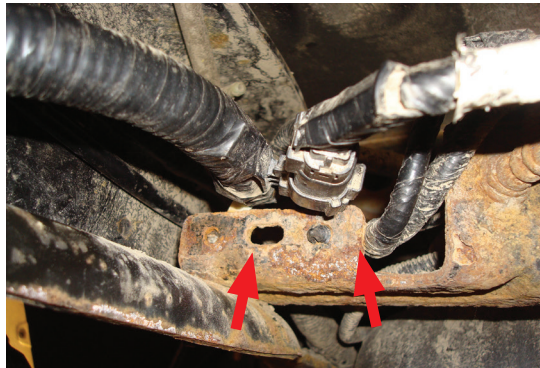

fig. 3



fig. 4

3. If necessary, disconnect the wiring harness from the driver's side frame rail to gain clearance for the upper brace (Fig. 5). Also, push out the harness connector that holds the electrical lines going to the gas/urea tank in or out of the tank bracket. This will improve socket/bolt access that will be required for installing and tightening the frame brace. (Fig. 6)



Remove the line holders from the gas/urea tank bracket for easier access to the upper brace hardware.

fig. 5

4. If the truck has a fifth-wheel hitch already installed, **other than the standard factory Reese hitch** purchased with the truck, it will be necessary to remove the hardware that bolts the side bracket (plates) to the outside of the frame above the axle.

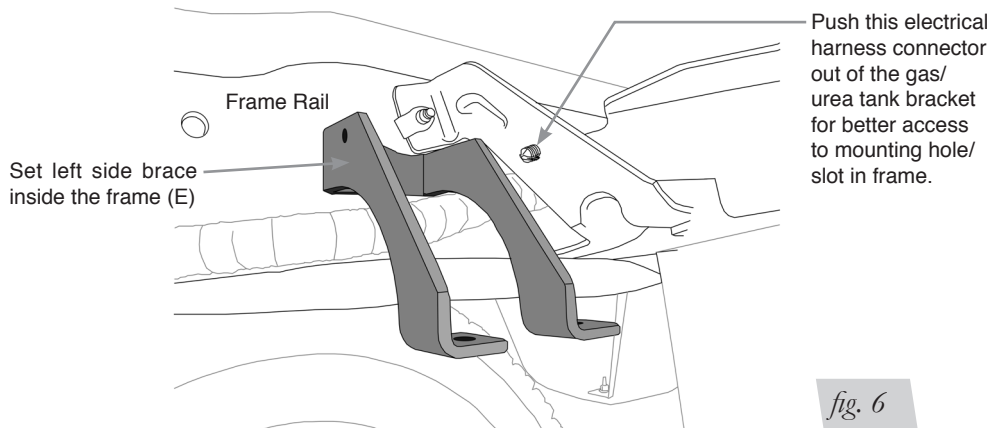

fig. 6

INSTALLING THE BRACES

Gas engine models have emission lines on the inside of the frame. If the truck has emission lines running along the inside of the frame rail (Fig. 7), it will be necessary to relocate those lines as follows:

1. Carefully push the line holder out of the frame above the axle. Try to minimize damage because it will be reused later. It may also be helpful to remove any emissions/fuel line retaining clips forward or rearward of the axle to aid in positioning the lines once the upper brace has been installed (Figs. 7 & 8). The same holds true for the electrical wire loom retaining clips.



If equipped, this emissions/fuel line retaining clip must be pulled away from the frame in order to install the upper frame brace (D).

fig. 7

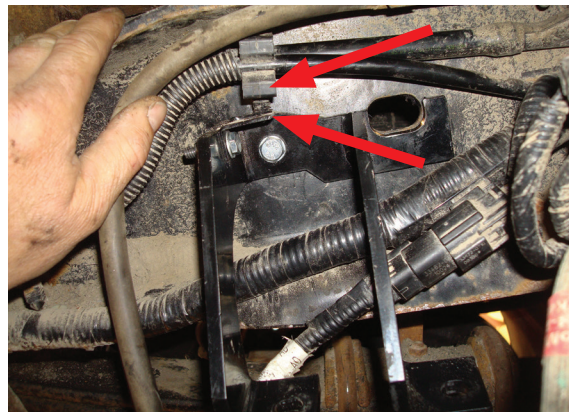

Image shows lines clear on the frame opening it up for the brace installation.

fig. 8

RETAINING CLIP L-BRACKET INSTALLATION ON BRACE

1. In order to reattach the previously removed emissions line, it will be necessary to attach the provided L-bracket (K) to the back frame brace using the 1/4"-20 x 1" bolt (M), flat washers #12 (BB) and 1/4"-20 nylon lock nut (G) supplied (Fig. 6). Placing this L-bracket depends on where the line holder is on the wiring or the emissions line that was previously pulled from the frame. Set the driver's side frame brace (D) up into the frame and insert the 8 mm-1.25 x 25 mm hex cap screw (P) with an 8 mm flat washer (X) through the brace and into the hole in the side of the frame from which the line holder was removed (Fig. 9). This will hold the line in place. Note what side the line holder is in, in respect to the back leg of the brace. Is it forward or behind the back leg of the brace? Where the line holder lines up is the side where the L-bracket is to be installed. (Figs. 6 & 9)



Brace being temporarily held in place by the 8 mm bolt and washer. L-bracket is shown in location already. Note: The side the line holder is on depends on the location of the factory retaining clip.

fig. 9

2. Pull the brace back out and attach the L-bracket onto the brace with the hardware noted above, in the proper location previously found (Figs. 10 & 11). Make sure the L-bracket faces up and tighten securely.



fig. 10

Attach the L-bracket to the brace in the position previously found using the hardware specified.

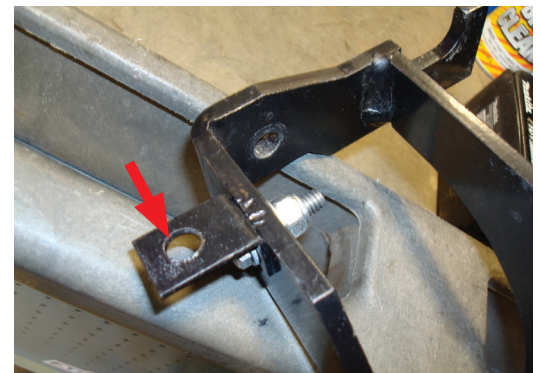

fig. 11

No matter what side the L-bracket is on, make sure it is installed so the flat side points up when tightening.

DRIVER'S SIDE BRACE INSTALLATION

1. Set the left upper brace (D) into the driver's side frame rail. The brace has a small hole that will line up with an existing hole in the frame. Insert the 8 mm-1.25 x 25 mm hex cap screw (P) with an 8 mm flat washer (X) through the brace and frame (Figs. 12 & 13) and cap with 8 mm flat washer (X) and 8 mm X 1.25 nylon lock nut (HH). Leave loose at this time.

CAUTION

BE SURE NOT TO PINCH THE PREVIOUSLY MOVED WIRING OR LINES INSIDE THE LEFT FRAME RAIL.

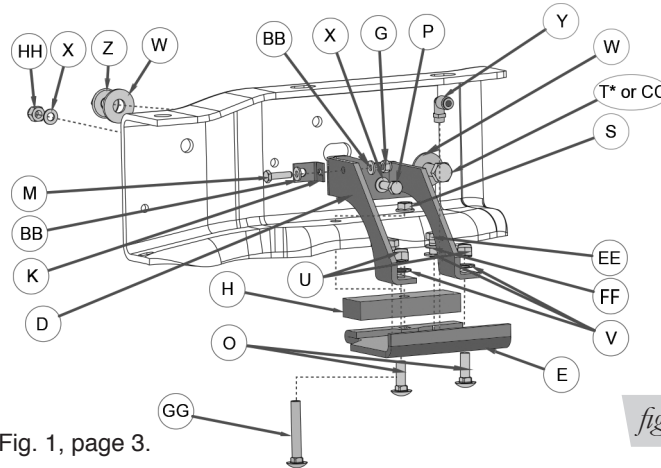

* See footnote in Fig. 1, page 3.

fig. 12



Attach the bracket to the frame using the 8 mm hardware noted.

fig. 13

2. If the truck has no fifth-wheel hitch or if it has the standard equipment Reese fifth-wheel hitch that was purchased on the truck from Ford, in the frame there is a slot that is forward of the 8 mm bolt just installed, insert the 1/2"-13 x 1.25" hex cap screw (T) and 1/2" flat washer (W) through the brace and frame (from the inside out). Cap with a 1/2" flat washer (W) and 1/2"-13 serrated flange lock nut (Z) (Figs. 12, 14 & 15). Do not tighten at this time.

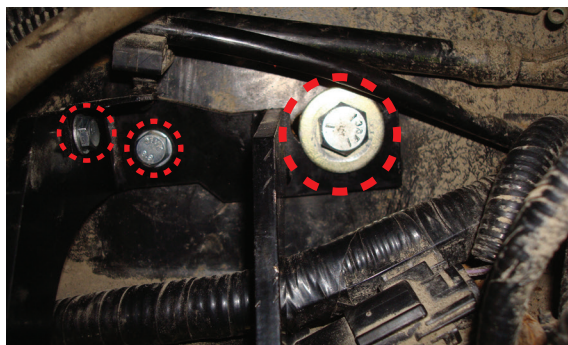

Driver's side brace shown with supplied hardware in place. Existing fifth-wheel hardware which may have been removed may look different.

fig. 14

If the truck has an aftermarket fifth-wheel hitch that has an outer bracket (plate) running alongside of the frame and it used this slot to secure the bracket with existing hardware, install the original fifth-wheel hardware previously removed in the “getting started section” from the fifth wheel installation for securing the brace (Fig. 12). Do not tighten at this time.

OR

If the truck has an aftermarket fifth-wheel hitch that has an outer bracket (plate) running alongside of the frame and it **does not have** any attaching hardware on the side where the slot in the frame is, it will be necessary to drill a 1/2” hole through the plate using the slot in the frame as a template. Drill the hole as far to the rear of the slot as possible.

CAUTION

CLEAR ANY ELECTRICAL OR HARD LINES FROM THE AREA SO AS NOT TO DAMAGE THEM WHEN DRILLING THE HOLE.

NOTE

It may be necessary to mark and remove the outer bracket (plate) from the side of the frame in order to drill the hole correctly. Reattach once the hole is drilled.

3. Insert a 1/2”-13 x 3” hex cap screw (CC) with a 1/2” flat washer (W) through the brace, frame and fifth wheel plate previously drilled. Cap with a 1/2” flat washer (W) and a 1/2”-13 serrated flange lock nut (Z) (Fig. 15). Leave loose at this time.

Rear view of driver’s (left) side shown

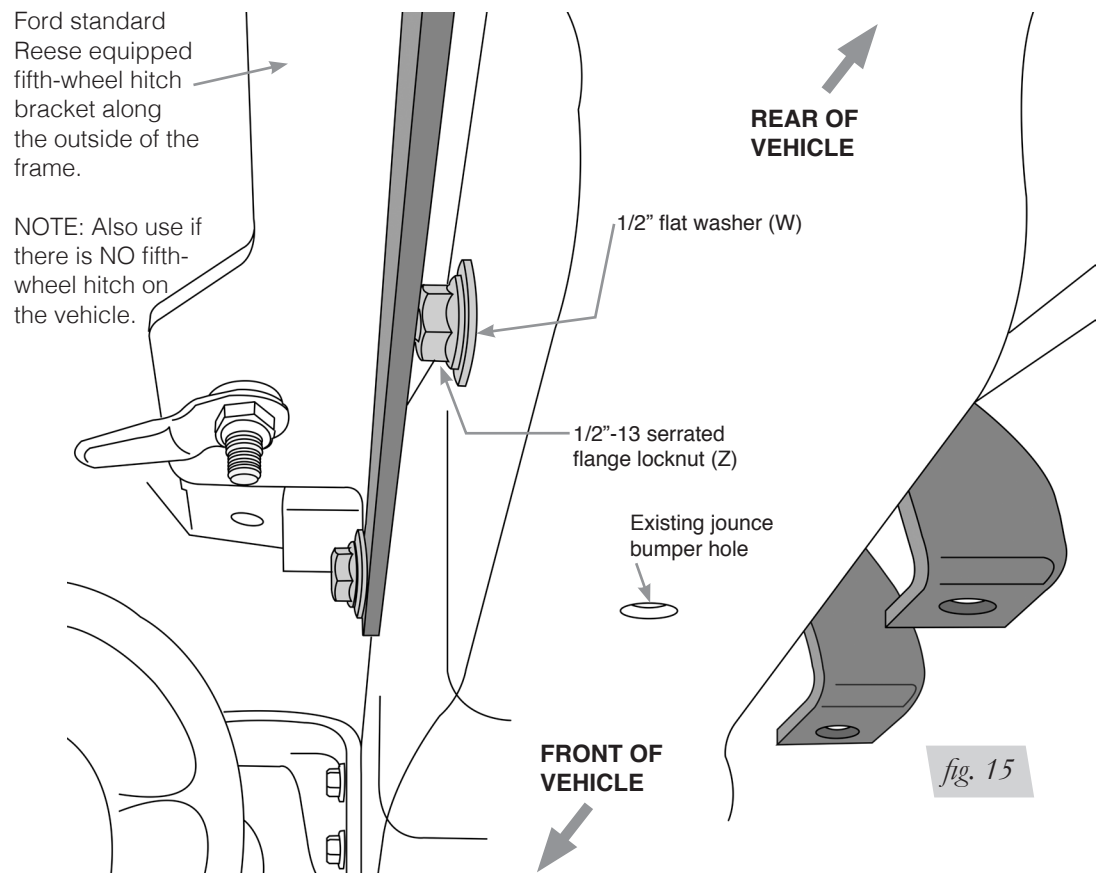

PASSENGER'S SIDE BRACE INSTALLATION

1. Set the right upper brace (C) into the passenger's side frame rail. (Figs. 16, 17 & 18)

Inside view of passenger's (right) side frame shown

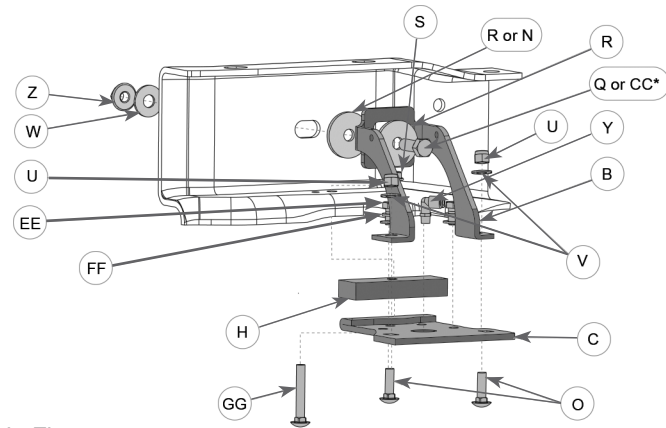

* See footnote in Fig. 1, page 3.

fig. 16

← FRONT OF VEHICLE

REAR OF VEHICLE →

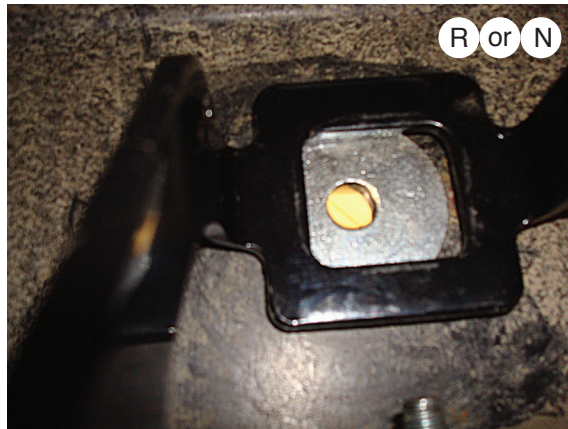

For the passenger's side, before inserting the upper brace hardware, make sure that the 1/2" thick washer (R) or (N) is installed in between the brace and frame (see Step 2). Note: The 1/2" thick washer (R) is not a half inch thick. It has a 1/2" hole and is a thick washer.

fig. 17



Passenger side upper brace shown with hardware supplied in place.

fig. 18

- For trucks with **no fifth-wheel or the OEM-purchased Reese fifth-wheel hitch**, insert the 1/2"-13 x 1.50" hex cap screw (Q) and 1/2" thick flat washer (R) through the brace, between the brace and the frame add the 1/2" thick flat washer (R) then through the frame (from the inside out).

NOTE

The 1/2" thick flat washer (R) is not a half inch thick. It has a 1/2" hole and is a thick washer.

OR

If the truck has an aftermarket fifth-wheel hitch that has an outer bracket (plate) running alongside of the frame and it used this slot to secure the bracket to the frame with existing hardware, re-install the original hardware previously removed in the "Getting Started" section. However, add the 1/2" thick flat washer (R) or 3/4" flat washer (N) depending on whether the existing hardware is in between the brace and the frame. (Figs. 16 & 17)

OR

If the truck has an aftermarket fifth-wheel hitch that has a bracket (plate) running alongside of the frame and it **does not have** any attaching hardware on the side where the slot in the frame is, it will be necessary to drill a 1/2" hole through the plate using the slot in the frame as a template.

NOTE

It may be necessary to mark and remove the bracket (plate) from the side of the frame in order to drill the hole correctly. Reattach once the hole is drilled.

- Insert a 1/2"-13 x 3" hex cap screw (CC) with a 1/2" thick flat washer (R) through the brace. Between the brace and the frame add another 1/2" thick flat washer (R) then slide the hex cap screw through the frame and fifth-wheel plate previously drilled. Cap with a 1/2" flat washer (W) and a 1/2"-13 serrated flange lock nut (Z) (Fig. 15). Leave loose at this time.

BELLOWS AND BRACKET ASSEMBLY

- Set roll plates (I) over the top and bottom of the bellows (J). (Figs. 1 & 19)

NOTE

The radiused (rounded) edge of the roll plate (I) will be toward the bellows so that the bellows is seated inside the roll plates.

- Install the swivel elbow fitting (Y) into the top of the bellows finger tight. Tighten the swivel fitting 1 1/2 turns. (Fig. 19)

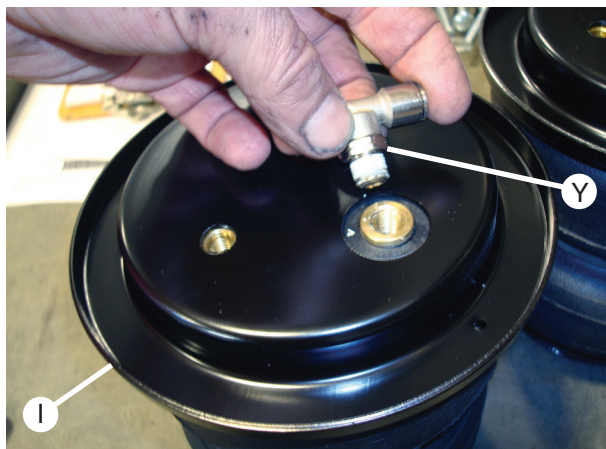

Set roll plate (I) over the bellows and install the fitting (Y) as stated. Repeat for both bellows.

fig. 19

3. Insert one of the 3/8"-16 X 7" carriage bolts (L) through the square hole in the lower brackets (A). The driver's or left side is shown in Figure 20. Determine which holes correspond with either side (Fig. 21). The passenger's side or right side is shown in Figure 22.

NOTE

The 3/8"-16 x 7" carriage bolts will be behind the axle once the assembly is installed on the axle.



fig. 20

Place 3/8"-16 x 7" carriage bolts into the square holes. (Driver's (left) side shown).

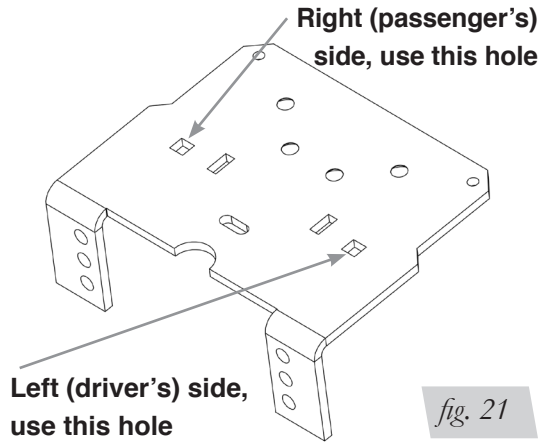

fig. 21



fig. 22

3/8-16 X 7" carriage bolts go into the square holes. Passenger's (right) side shown.

4. The lower bracket assembly has two sets of bellows mounting holes, one for the driver's side, the other for the passenger's. Using the corresponding holes in the lower bracket designated (Figs. 23 & 24), attach the bellows to the bracket using two 3/8"-24 hex cap screws (EE), two 3/8" lock washers (FF) and two 3/8" flat washers (V). Torque to no more than 20 lb.-ft.

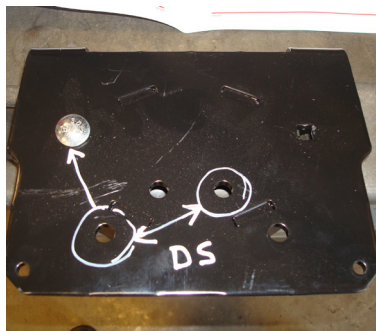

fig. 23

Driver's side (left) bellows mounting holes shown in location to the 3/8-16 X 7" carriage bolt previously installed. When installing on the bellows, make sure the bracket edge facing you is on the fitting side.

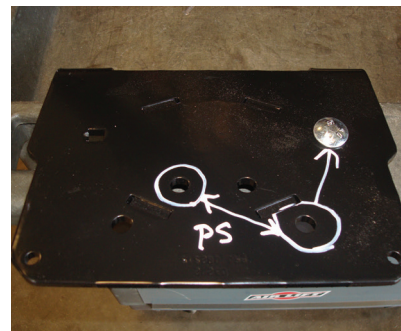

fig. 24

Passenger's side (right) bellows mounting holes shown in location to the 3/8-16 X 7" carriage bolt previously installed. When installing on the bellows, make sure the bracket edge facing you is on the fitting side.

5. Figure 25 shows the driver's side and passenger's side assemblies.

NOTE

The 3/8"-16 x 7" carriage bolts will be behind the axle once the assembly is installed on the axle.

Driver's Side



Passenger's Side

The bellows fitting must be on this side of the assembly opposite the flanges.

fig. 25

6. Set the lower bracket assembly aside. Pick up the driver side (E) and passenger side (C) upper brackets (Figs. 26 & 27). Insert two 3/8"-16 X 1.25" carriage bolts (O) up through the bottom of the driver side (E) and passenger side (C) upper brackets (Figs. 26 & 27), through the two square holes that are on the corresponding side. Also, insert one 3/8"-16 X 2" carriage bolt (GG) through the remaining hole. The head of this carriage bolt will be hidden once the upper bracket is mounted to the bellows.

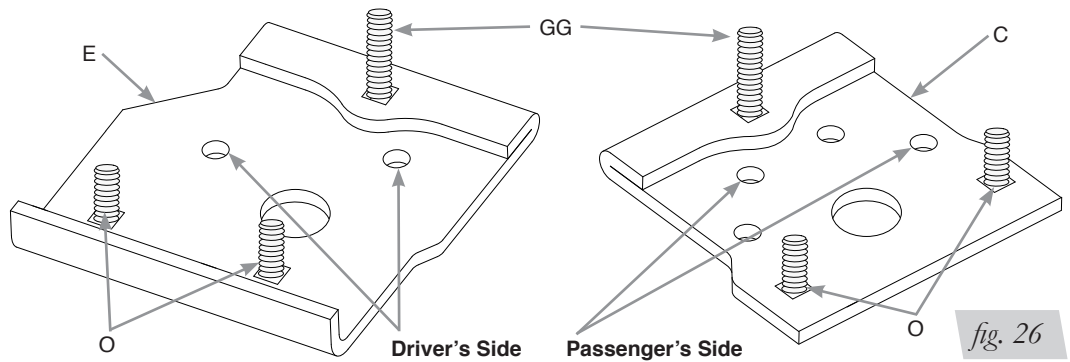
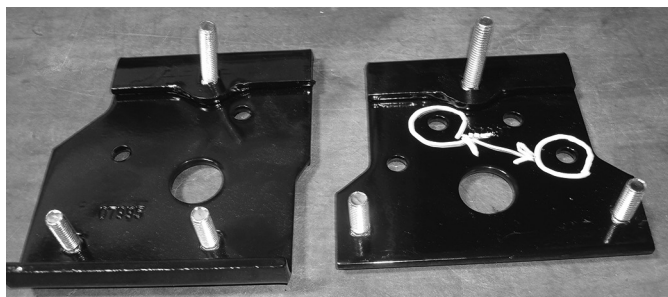

fig. 26



Driver's Side

Passenger's Side

fig. 27

NOTE

One of the 3/8"-16 X 1.25" carriage bolts (O) will not be covered by the roll plate and may fall out. If so, retain for use in the "Attaching the Assemblies to the Frame" section later in this manual.

7. Set the driver's side (left) upper bracket onto the driver's side bellows assembly previously assembled, using the holes in the upper bracket designated (Fig. 26 & 27), and attach to the bellows with two 3/8" flat washers (V), 3/8" lock washers (FF) and 3/8"-24 X 7/8" hex cap screw (EE). Torque no more than 20 lb.-ft. (Figs. 28 & 29)

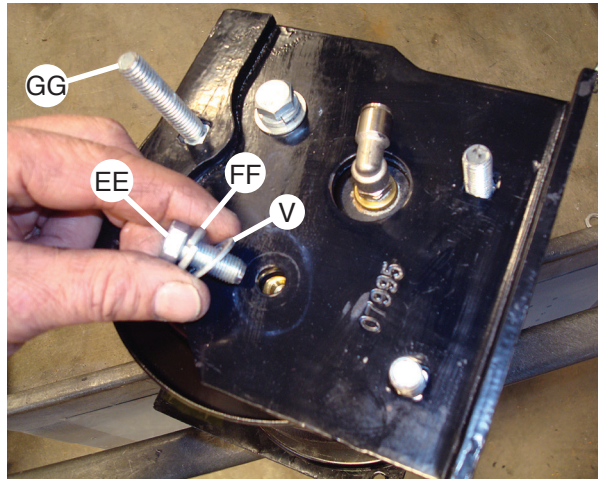
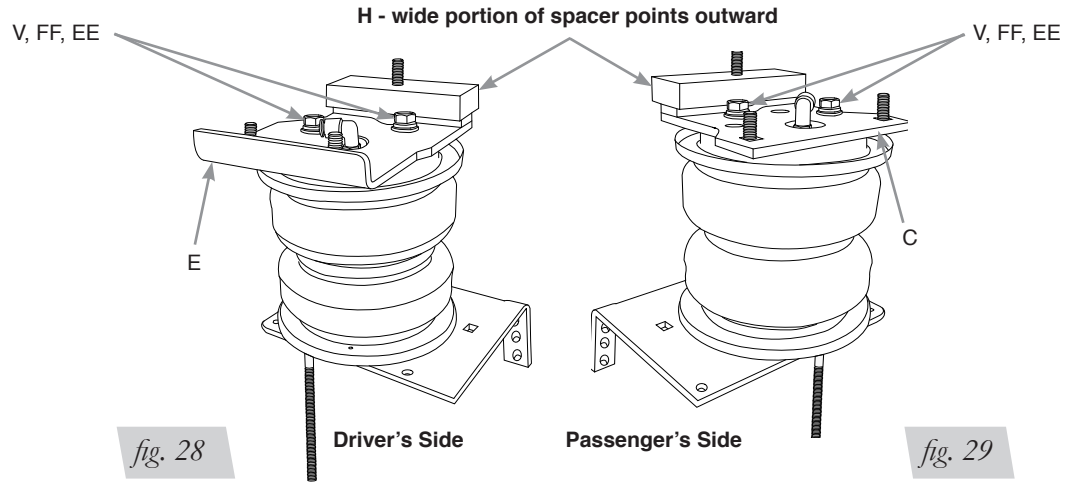

Attach the upper bracket to the bellows assembly with two 3/8" flat washers (V), 3/8" lock washers (FF), and 3/8"-24 x 7/8" hex head cap screws (EE).

fig. 30

8. Repeat the above process on the passenger's side assembly (Fig. 29).
9. Set the spacers (H) over both 3/8"-16 X 2" carriage bolts (GG). (Figs. 28, 29 & 31)

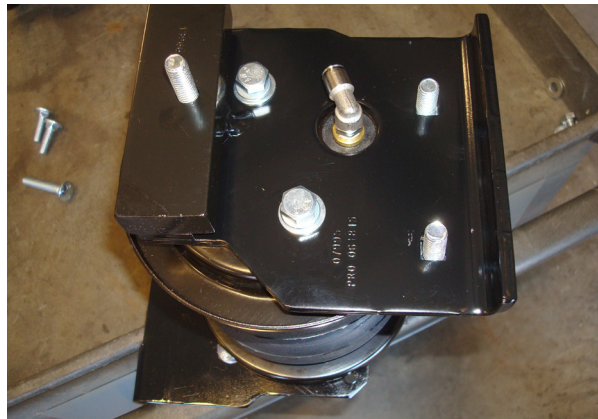

Spacer (H) set on bracket in position. The wide side of the spacer faces the outside of the vehicle.

fig. 31

10. Figure 32 shows the complete assemblies upside down and ready to install.

Driver's side assembly



Passenger's side assembly

fig. 32

ATTACHING THE ASSEMBLIES TO THE FRAME

1. Drop the axle or raise the frame to make room to put the assemblies into position.
2. It may be necessary to move the ABS line under the hard brake line bracket that is bolted to the spring perch, behind the axle, to make room for the legs on the lower bracket (Fig. 33). Unbolt the hard brake line and slide the clamps holding the ABS lines, down so that the line will be below the brake line bracket once bolted back into position. Reattach the brake line bracket back onto the spring perch using the same hardware removed (Fig. 34). Repeat for the other side.



ABS line in stock location

fig. 33

ABS line shown in stock location.

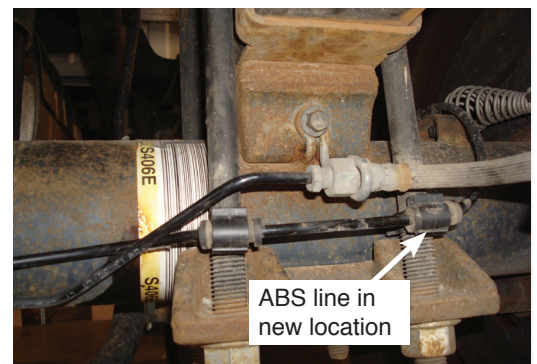

ABS line in new location

fig. 34

New location for ABS line.

- Set the left (driver's side) assembly onto the axle (Fig. 35). Make sure the 3/8"-16 X 7" carriage bolt (L) on the bottom bracket goes in between the hard brake line and axle, on the back side of the axle. Raise the axle just enough to insert the 3/8"-16 X 2" carriage bolt (GG) (that is installed in the upper bracket) through the existing jounce bumper hole in the bottom of the frame. At the same time, line up the upper brace into the remaining two carriage bolts in the assembly's upper bracket (Fig. 36). Do this just enough for the carriage bolts to hold the assembly into position in the frame, while resting on the axle. (Fig. 35)

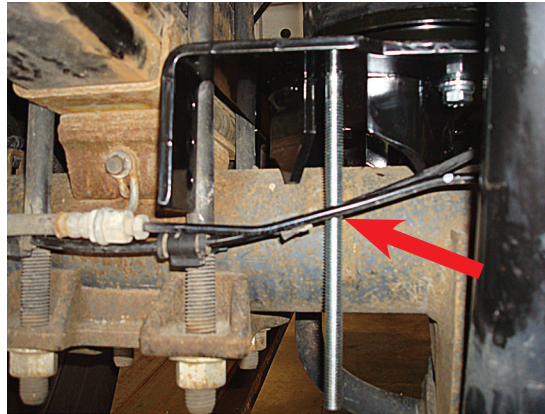

The long carriage bolt must go in between the axle and the hard brake/ABS line on the driver's side.

fig. 35

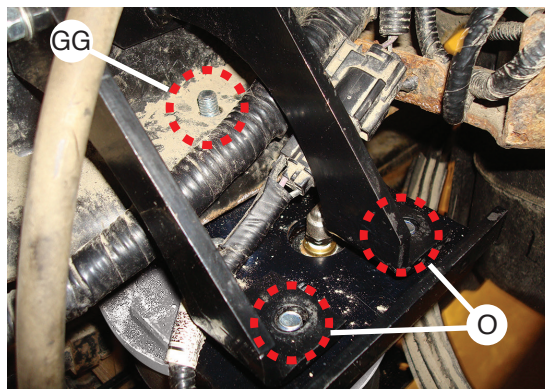

Raise the axle up while aligning the 3/8"-16 x 2" carriage bolt through the frame and the two 3/8"-16 X 1.25" carriage bolts in the upper bracket, through the brace.

fig. 36

- Set the right (passenger's side) assembly into position on the axle the same way the left side was positioned (Fig. 37). Note that the long carriage bolt goes outside of the hard brake line on the passenger's side.

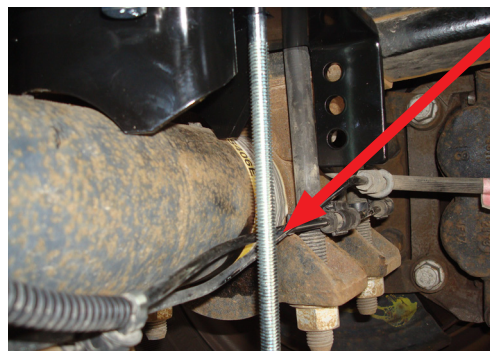

The long carriage bolt goes on the outside (backside) of the hard brake/ABS line on the passenger's side.

fig. 37

5. Make sure the thick spacer (H) is parallel to the frame and bracket (Fig. 38). Finish raising the axle or lowering the frame until the spacer contacts the frame on both sides.

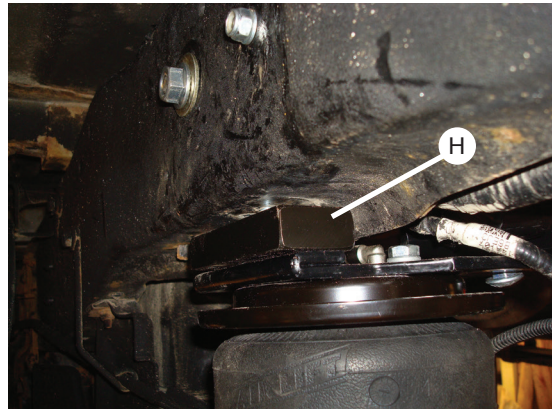

The spacer (H) must be parallel to both the frame and upper bracket. Raise axle or lower frame until the spacer touches the frame on both sides.

fig. 38

6. Install the 3/8"-16 serrated flange locknut (S) on the 3/8"-16 X 2" carriage bolt (GG) that went through the existing jounce bumper hole and tighten securely on both sides (Fig. 39).

CAUTION

BE SURE NOT TO PINCH THE PREVIOUSLY MOVED WIRING OR LINES INSIDE THE LEFT FRAME RAIL.

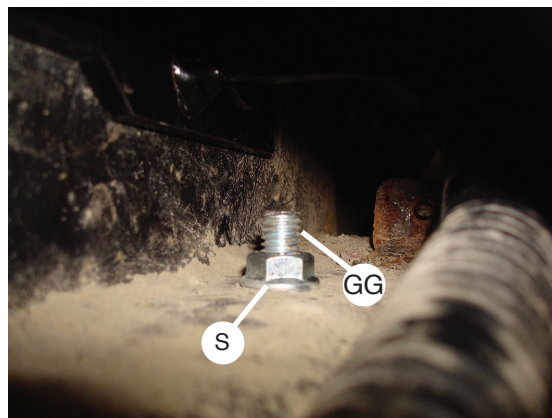

Install the 3/8"-16 serrated flange locknut (S) onto the 3/8"-16 x 2" carriage bolt (GG) that goes through the flange on the frame and tighten.

fig. 39

7. Cap the 3/8"-16 X 1.25" carriage bolts (O) with a 3/8" flat washer (V) and 3/8" nylon lock nut (U) on both sides and torque to 15 lb.-ft. (Fig. 40)

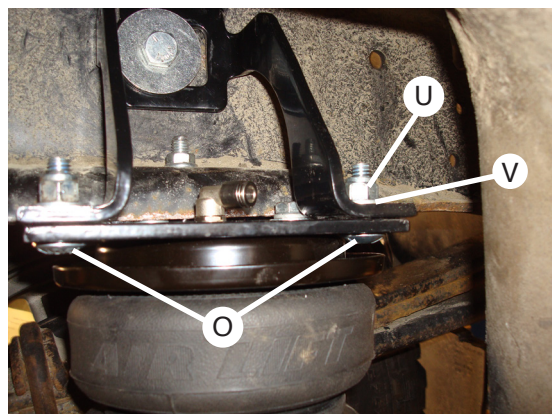

Cap the 3/8"-16 x 1.25" carriage bolts with 3/8" nylon lock nuts and torque to 15 lb.-ft. Repeat for both sides.

fig. 40

- With the spacers (H) on the upper brackets tight to the bottom of the frame and the braces tight to the upper brackets, tighten the 8 mm (driver's side only) and 1/2" or 3/4" hardware previously installed, that hold the braces to the frame (Fig. 41). Tighten both sides.

NOTE

If possible, use a thin-wall socket. It helps to pull back the driver's side mounting hardware (T or CC) as far back in the slot as possible while tightening.

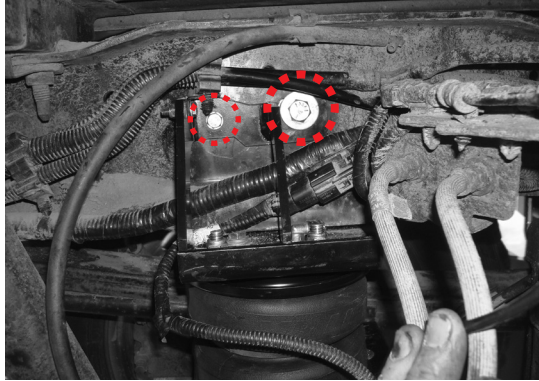

Tighten the 8 mm and 1/2" (or 3/4" from the existing fifth-wheel hitch) hardware securely. Repeat for the hardware on the opposite side.

fig. 41

- Once the left (driver's side) 1/2" or 3/4" hardware has been tightened, push the wiring harness connector — which was removed in the "getting started session" — back into the gas/urea tank connector mounting hole. If the connector broke during disassembly, wire tie it to the bracket. (Figs. 5 & 6)
- If equipped with the emissions line previously loosened from the frame, insert the line holder post into the L-bracket (K) attached to the back leg of the upper left brace (D) (Fig. 42). It may be necessary to move the line holder post forward or back on the lines to line up correctly with the L-bracket hole. Reattach any line holders removed forward or behind the axle, if possible, that were removed to aid in positioning the upper bracket.

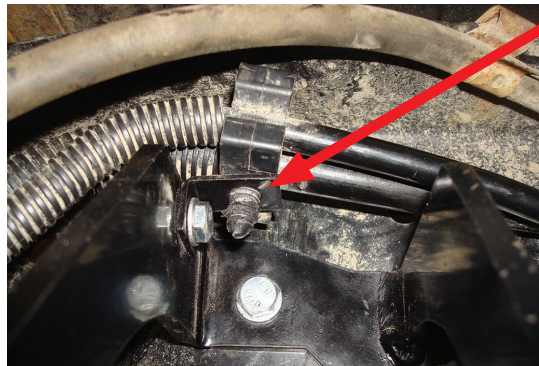

Insert the line holder previously removed into the L-bracket installed on the upper brace as shown.

fig. 42

ATTACHING THE LOWER BRACKET

1. Push the lower bracket up against the stock U-bolts so that the legs of the bracket are locked into position around the stock U-bolts (Fig. 43).

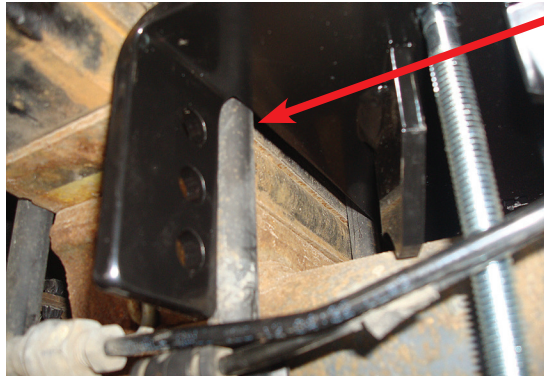

Rotate the lower bracket on the spring perch if necessary and push the bracket up against the U-bolts to put the lower bracket into position.

fig. 43

2. Position the U-bolt (AA) around the leaf spring assembly and insert in the hole closest to the leaf spring stack (Fig. 44). The lower bracket flanges must be locked on the front and rear of the stock U-bolts holding the leaf springs to the axle.

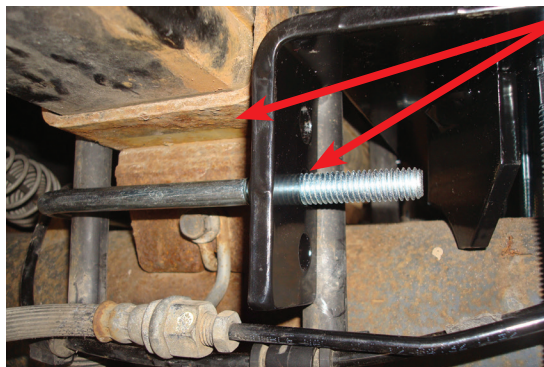

Use closest hole to the leaf spring.

fig. 44

3. Cap the U-bolts with two 3/8" flat washers (V) and two 3/8" nylon lock nuts (U) and evenly tighten only enough to draw the bracket up against the stock U-bolt at this time (Fig. 45). Repeat for the other side. Make sure the bracket rests against the stock U-bolts (Fig. 46).

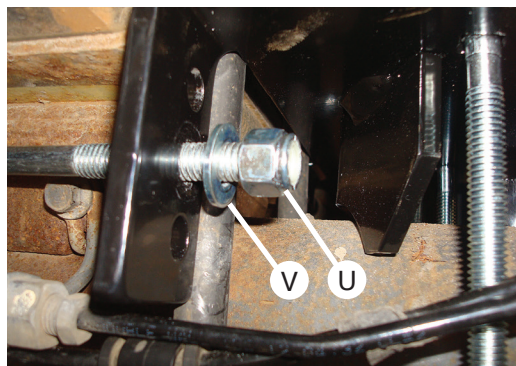

fig. 45

Evenly tighten only enough to draw the lower bracket to the stock U-bolts at this time.



fig. 46

Bracket must be up against the stock U-bolts and the flanges of the lower bracket must be locked forward and behind the stock U-bolts.

4. Insert the remaining 3/8"-16 X 7" carriage bolt (L) through the remaining square hole in the lower bracket (forward of the axle) opposite of the one previously installed during the bellows assembly. Set the clamp bar (F) over the carriage bolts (L) and cap with two 3/8" flat washers (V) and 3/8" nylon lock nuts (U) (Fig. 47). Repeat for the opposite side. Leave loose at this time.

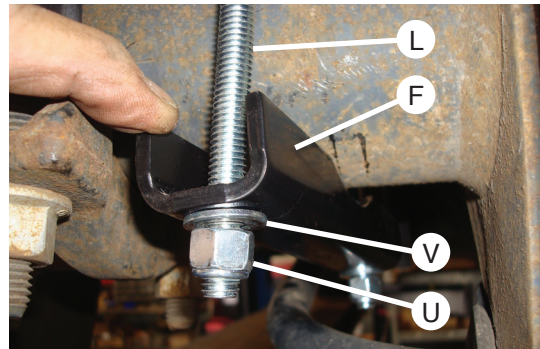

Set the clamp bar over the 3/8"-16 x 7" carriage bolts and cap with 3/8" flat washers and 3/8" nylon lock nuts. Leave loose at this time.

fig. 47

5. Tighten the axle clamp bar hardware evenly until it touches the axle (see note below). Torque the axle clamp bar bolts to 16 lb.-ft. (Fig. 48). Repeat for the opposite side. Trim the 3/8"-16 X 7" bolts below, the nylon lock nuts if necessary.

NOTE

Do not pinch the hard brake line on the passenger's side while tightening.



It may be necessary on some models to not tighten the axle clamp bar evenly on the right (passenger's) side so that the clamp bar will clear the hard brake line.

fig. 48

6. Torque the leaf spring U-bolt hardware to 10 lb.-ft. Repeat for the opposite side. Once tight, the upper and lower brackets will not be parallel and may look like they are out of alignment. This condition will be OK because of the way the lower bracket and upper bracket mounts are designed. Some variance from one unit to another is considered normal.
7. Raise the axle up all the way (if not already done so) and remove the jack stands or equivalent used during the installation.

FINISHING THE INSTALLATION

1. Install the P-clamp (II) onto the driver's side (left) lower bracket to hold the emergency brake line away from the bellows. Set the P-clamp over the emergency brake line near the lower bracket corner on the driver's side (left) like shown (Fig. 49).



Set P-clamp over the emergency brake cable.

fig. 49

2. Set the P-clamp on the top of the lower bracket in the corner and attach to the bracket using the 5/16"-18 hex cap screw (QQ) 5/16" flat washer (PP) through the P-clamp and the hole in the corner of the lower bracket. Cap with 5/16" flat washer (PP) and 5/16"-18 nylon lock nut (RR) (Figs. 50 & 51). Tighten securely.

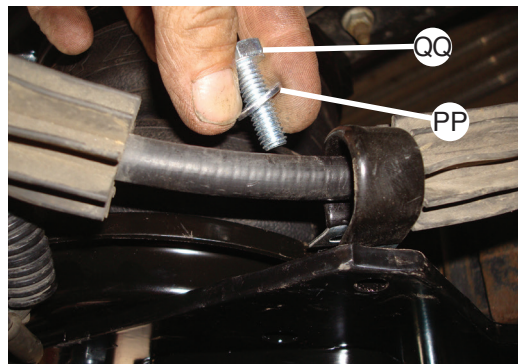

fig. 50

Attach P-clamp to the corner of the lower bracket.

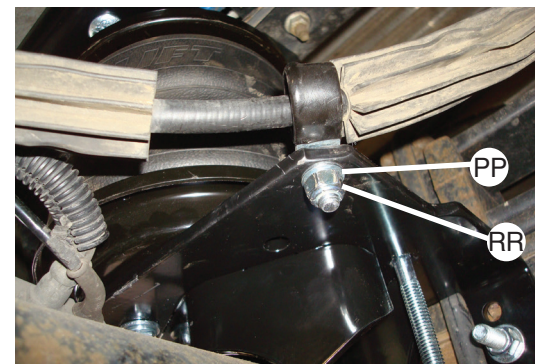

fig. 51

3. Finish the installation of the air springs by tying together the soft brake/ABS lines together that are close to the bellows roll plates, above the junction block on the left side of the axle, with the large zip tie (LL) (Fig. 52).



fig. 52

INSTALLING THE AIR LINES

1. Choose a convenient location for mounting the inflation valves. Popular locations for the inflation valve are:
 - a. The wheel well flanges
 - b. The license plate recess in bumper
 - c. Under the gas cap access door
 - d. Through the license plate

NOTE

Whatever the chosen location, make sure there is enough clearance around the inflation valves for an air chuck.

2. Drill two 5/16" holes to install the inflation valves.
3. Cut the air line assembly in two equal lengths.

TIPS FOR INSTALLING AIR LINES

When cutting air lines, use a sharp knife or a hose cutter and make clean, square cuts (Fig. 53). Do not use scissors or wire cutters because these tools may deform the air line, causing it to leak around fittings. Do not cut the lines at an angle.

Do not bend the 1/4" hose at a radius of less than 1" and don't put side load pressure on fitting. The hose should be straight beyond the fitting for 1" before bending.

Inspect hose for scratches that run lengthwise on hose prior to installation. Contact Air Lift customer service at (800) 248-0892 if the air line is damaged.

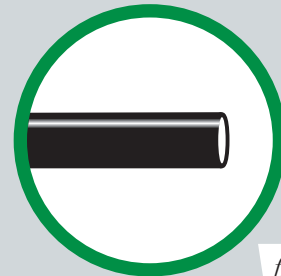

To watch a video demonstrating proper air line cutting, go to air-lift.co/cuttingairline

fig. 53

4. Place a 5/16" nut and star washer on the air valve. Leave enough of the inflation valve in front of the nut to extend through the hole and have room for the rubber washer, flat washer, and 5/16" nut and cap. There should be enough valve exposed after installation – approximately 1/2" – to easily apply a pressure gauge or an air chuck. (Fig. 54)

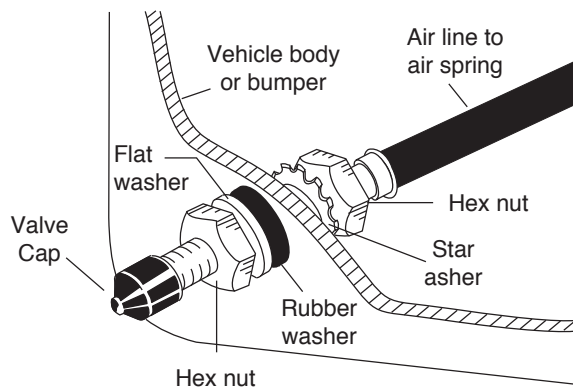
fig. 54

5. Push the inflation valve through the hole and use the rubber washer, flat washer, and another 5/16" nut to secure it in place. Tighten the nuts to secure the assembly.
6. Route the air line along the frame to the air fitting on the air spring (Fig. 55). Keep AT LEAST 6" of clearance between the air line and heat sources, such as the exhaust pipes, muffler, or catalytic converter. Avoid sharp bends and edges. Use plastic tie straps to secure the air line to fixed points along the chassis. Be sure that the tie straps are tight, but do not pinch the air line. Leave at least 2" of slack to allow for any movement that might pull on the air line.

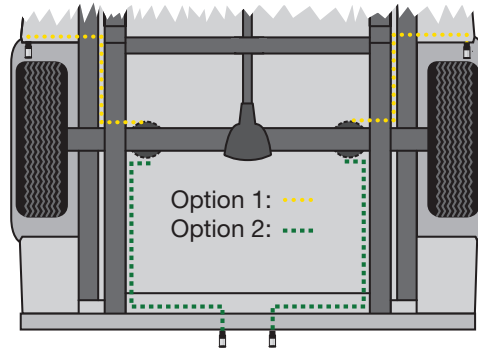

fig. 55

7. Before installing the right (passenger) side hose, install the hose heat shield over the hose (Fig. 56). Once the hose has been inserted into the fitting, push the hose heat shield up to the fitting.



Hose heat shield shown in place on the right side (passenger) of the vehicle. Make sure heat shield is pushed up against the fitting once the hose is installed.

fig. 56

8. Cut off the air line, leaving approximately 12" of extra air line. A clean square cut will prevent leaks. Insert the air line into the air fitting. This is a push-to-connect fitting. Simply push the air line into the 90° swivel fitting until it bottoms out (9/16" of air line should be in the fitting).

CHECKING FOR LEAKS

1. Inflate the air spring to 30 PSI.
2. Spray all connections and the inflation valves with a solution of 1/5 liquid dish soap and 4/5 water. Spot leaks easily by looking for bubbles in the soapy water.
3. After the test, deflate the springs to the minimum pressure required to restore the system to normal ride height. Do not deflate to lower than 5 PSI.
4. Check the air pressure again after 24 hours. A 2-4 PSI loss after initial installation is normal. Retest for leaks if the loss is more than 5 PSI.

FIXING LEAKS

1. If there is a problem with the swivel fitting:
 - a. Check the air line connection by deflating the spring and removing the line by pulling the collar against the fitting and pulling firmly on the air line. Trim 1" off the end of the air line. Be sure the cut is clean and square (see Fig. 53). Reinsert the air line into the push-to-connect fitting.
 - b. Check the threaded connection by tightening the swivel fitting another half turn. If it still leaks, deflate the air spring, remove the fitting, and re-coat the threads with thread sealant. Reinstall by hand tightening as much as possible and then use a wrench for an additional two turns.
2. If there is a problem with the inflation valve:
 - a. Check the valve core by tightening it with a valve core tool.
 - b. Check the air line by removing the air line from the barbed type fitting. Cut the air line off a few inches in front of the fitting and use a pair of pliers or vice grips to pull/twist the air line off of the fitting.

CAUTION

DO NOT CUT OFF THE AIR LINE COMPLETELY AS THIS WILL USUALLY NICK THE BARB AND RENDER THE FITTING USELESS.

3. If the preceding steps have not resolved the problem, call Air Lift customer service at (800) 248-0892.

INSTALLING THE HEAT SHIELD

1. Bend tabs to provide a dead air space between exhaust pipe and heat shield. (Fig. 57) Attach the heat shield to the exhaust pipe using the clamps. Bend the heat shield for maximum clearance to the air spring.

NOTE

Some vehicles have large resonators in this area; it will be necessary to double up on the clamps to fit these models. (Fig. 57)

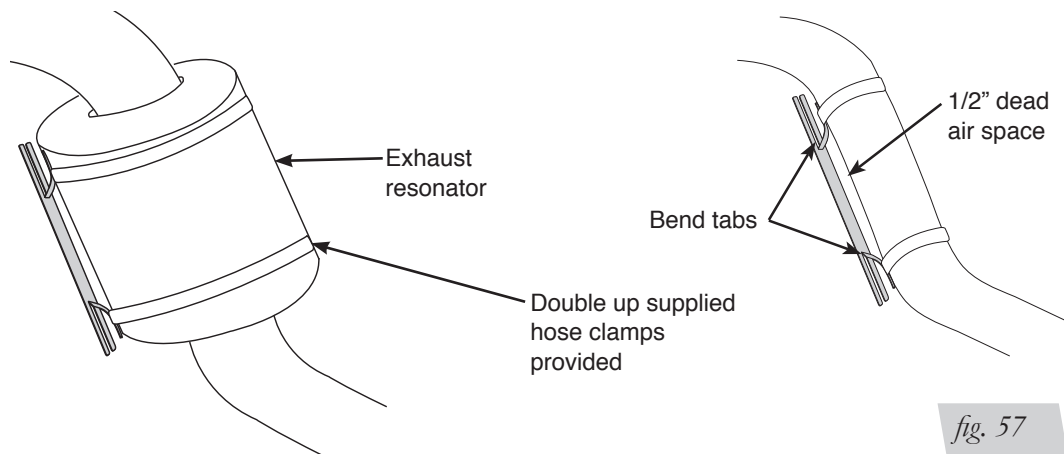

fig. 57

FINISHED INSTALLATION PHOTOS

1. The following images show the finished installation of both sides. (Figs. 58, 59, 60 & 61)



Left (driver's side) view of the kit installed from the rear.



Right (passenger's side) view of the kit installed.



Left (driver's side) view of the kit installed from rear center of vehicle.



Right (passenger's side) view of the kit installed from forward of the axle.

Before Operating

INSTALLATION CHECKLIST

- Clearance test** — Inflate the air springs to 75-90 PSI and make sure there is at least 1/2" clearance from anything that might rub against each sleeve. Be sure to check the tire, brakes, frame, shock absorbers and brake cables.

- Leak test before road test** — Inflate the air springs to 75-90 PSI and check all connections for leaks. All leaks must be eliminated before the vehicle is road tested.

- Heat test** — Be sure there is sufficient clearance from heat sources, at least 6" for air springs and air lines. If a heat shield was included in the kit, install it. If there is no heat shield, but one is required, call Air Lift customer service at **(800) 248-0892**.

- Fastener test** — Recheck all bolts for proper torque.

- Road test** — The vehicle should be road tested after the preceding tests. Inflate the springs to recommended driving pressures. Drive the vehicle 10 miles and recheck for clearance, loose fasteners and air leaks.

- Operating instructions** — If professionally installed, the installer should review the operating instructions with the owner. Be sure to provide the owner with all of the paperwork that came with the kit.

POST-INSTALLATION CHECKLIST

- Overnight leak down test** — Recheck air pressure after the vehicle has been used for 24 hours. If the pressure has dropped more than 5 PSI, then there is a leak that must be fixed. Either fix the leak yourself or return to the installer for service.

- Air pressure requirements** — It is important to understand the air pressure requirements of the air spring system. Regardless of load, the air pressure should always be adjusted to maintain adequate ride height at all times while driving.

- Thirty-day or 500-mile test** — Recheck the air spring system after 30 days or 500 miles, whichever comes first. If any part shows signs of rubbing or abrasion, the source should be identified and moved, if possible. If it is not possible to relocate the cause of the abrasion, the air spring may need to be remounted. If professionally installed, the installer should be consulted. Check all fasteners for tightness.

Product Use, Maintenance and Servicing

Minimum Recommended Pressure	Maximum Air Pressure
5 PSI	100 PSI

MAINTENANCE GUIDELINES

NOTE

By following the steps below, vehicle owners will obtain the longest life and best results from their air springs.



1. Check the air pressure weekly.
2. Always maintain normal ride height. Never inflate beyond 100 PSI.
3. If you develop an air leak in the system, use a soapy water solution (1/5 liquid dish soap and 4/5 water) to check all air line connections and the inflation valve core before deflating and removing the air spring.

FOR SAFETY AND TO PREVENT POSSIBLE DAMAGE TO THE VEHICLE, DO NOT EXCEED MAXIMUM GROSS VEHICLE WEIGHT RATING (GVWR), AS INDICATED BY THE VEHICLE MANUFACTURER. ALTHOUGH THE AIR SPRINGS ARE RATED AT A MAXIMUM INFLATION PRESSURE OF 100 PSI, THE AIR PRESSURE ACTUALLY NEEDED IS DEPENDANT ON LOAD AND GVWR.

4. Loaded vehicles require at least 25 PSI. A “loaded vehicle” refers to a vehicle with a heavy bed load, a trailer or both. Never exceed GVWR, regardless of air spring, air pressure or other load assist. The springs in this kit will support approximately 40 pounds of load (combined on both springs) for each 1 PSI of pressure. The required air pressure will vary depending on the state of the original suspension. Operating the vehicle below the minimum air spring pressure will void the Air Lift warranty.
5. When increasing load, always adjust air pressure to maintain normal ride height. Increase or decrease pressure from the system as necessary to attain normal ride height for optimal ride and handling. Remember that loads carried behind the axle (including tongue loads) require more leveling force (pressure) than those carried directly over the axle.
6. Always add air to springs in small quantities, checking the pressure frequently.
7. Should it become necessary to raise the vehicle by the frame, make sure the system is at minimum pressure (5 PSI) to reduce the tension on the suspension/brake components. Use of on board leveling systems do not require deflation or disconnection.
8. Periodically check the air spring system fasteners for tightness. Also, check the air springs for any signs of rubbing. Realign if necessary.
9. On occasion, give the air springs a hard spray with a garden hose in order to remove mud, sand, gravel or other abrasive debris.

TROUBLESHOOTING GUIDE

1. Leak test the air line connections, the threaded connection into the air spring, and all fittings in the control system.
2. Inspect the air lines to be sure none are pinched. Tie straps may be too tight. Loosen or replace the strap and replace leaking components.
3. Inspect the air line for holes and cracks. Replace as needed.
4. Look for a kink or fold in the air line. Reroute as needed.

If the preceding steps do not solve the problem, it is possibly caused by a failed air spring — either a factory defect or an operating problem. Please call Air Lift at (800) 248-0892 for assistance.

FREQUENTLY ASKED QUESTIONS

Q. Will installing air springs increase the weight ratings of a vehicle?

No. Adding air springs will not change the weight ratings (GAWR, GCWR and/ or GVWR) of a vehicle. Exceeding the GVWR is dangerous and voids the Air Lift warranty.

Q. Is it necessary to keep air in the air springs at all times and how much pressure will they need?

For LoadLifter 5000 Ultimate, the recommended minimum air pressure is 5 PSI, but it can safely be run at zero air pressure.

Q. Is it necessary to add a compressor system to the air springs?

No. Air pressure can be adjusted with any type of compressor as long as it can produce sufficient pressure to service the springs. Even a bicycle tire pump can be used, but it's a lot of work.

Q. How long should air springs last?

If the air springs are properly installed and maintained they can last indefinitely.

Q. Will raising the vehicle on a hoist for service work damage the air springs?

No. The vehicle can be lifted on a hoist for short-term service work such as tire rotation or oil changes. However, if the vehicle will be on the hoist for a prolonged period of time, support the axle with jack stands in order to take the tension off of the air springs.

TUNING THE AIR PRESSURE

Pressure determination comes down to three things — level vehicle, ride comfort and stability.

1. Level vehicle

If the vehicle's headlights are shining into the trees or the vehicle is leaning to one side, then it is not level (Fig. 62). Raise the air pressure to correct either of these problems and level the vehicle.

2. Ride comfort

If the vehicle has a rough or harsh ride it may be due to either too much pressure or not enough (Fig. 63). Try different pressures to determine the best ride comfort.

3. Stability

Stability translates into safety and should be the priority, meaning the driver may need to sacrifice a perfectly level and comfortable ride. Stability issues include roll control, bounce, dive during braking and sponginess (Fig. 64). Tuning out these problems usually requires an increase in pressure.



Bad headlight aim

fig. 62



Rough ride

fig. 63

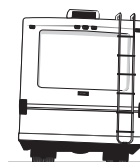

Sway and body roll

fig. 64

GUIDELINES FOR ADDING AIR

1. Start with the vehicle level or slightly above.
2. When in doubt, always add air.
3. If the front of the vehicle dives while braking, increase the pressure in the front air bags, if equipped.
4. If it is ever suspected that the air bags have bottomed out, increase the pressure. (Fig. 65)
5. Adjust the pressure up and down to find the best ride.
6. If the vehicle rocks and rolls, adjust the air pressure to reduce movement.
7. It may be necessary to maintain different pressures on each side of the vehicle. Loads such as water, fuel, and appliances will cause the vehicle to be heavier on one side (Fig. 66). As much as a 50 PSI difference is not uncommon.



Bottoming out

fig. 65

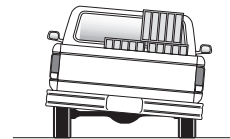

Unlevel

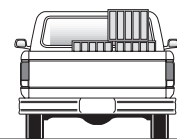

Level

fig. 66



Notes



Notes



Limited Warranty and Return Policy

WHAT THIS WARRANTY COVERS

Air Lift Company provides a warranty to the original purchaser of its Load Support Products, for the periods of time listed below, by product line, from the date of original purchase, that the products will be free from defects in workmanship and materials when used on cars and trucks as specified by Air Lift Company and under normal operating conditions, subject to the requirements and exclusions set forth below.

WHAT THIS WARRANTY DOES NOT COVER

The warranty does not apply to products that have been improperly applied, improperly installed, or which have not been maintained in accordance with installation instructions furnished with all products. This warranty does not apply and is void if damage or failure is caused by: accident, abuse, misuse (including but not limited to racing or off-road activities or commercial use), abnormal use, faulty installation, liquid contact, fire, earthquake or other external cause; operating the product outside Air Lift Company's instructions, specifications or guidelines; or service, alteration, maintenance or repairs performed by anyone other than Air Lift Company to the product from its purchased condition. This warranty also does not apply to: consumable parts, such as batteries; cosmetic damage, including but not limited to scratches or dents; defects caused by normal wear and tear or otherwise due to the normal aging of the product, or if any serial or identification number has been removed or defaced from the product. Air Lift Company reserves the right to change the design of any product without assuming any obligation to modify any product previously manufactured.

LIMITATION OF LIABILITY

To the extent permitted by law, this warranty and the remedies set forth herein are exclusive and in lieu of all other warranties, remedies and conditions, whether oral, written, statutory, express or implied. AIR LIFT COMPANY DISCLAIMS ALL STATUTORY AND IMPLIED WARRANTIES, INCLUDING WITHOUT LIMITATION, WARRANTIES OF MERCHANTABILITY AND FITNESS FOR A PARTICULAR PURPOSE AND WARRANTIES AGAINST HIDDEN OR LATENT DEFECTS TO THE EXTENT PERMITTED BY LAW. To the extent such warranties cannot be disclaimed, such implied warranties shall apply only for the warranty period specified above. Please note that some states do not allow limitation on how long an implied warranty (or condition) lasts. So the above limitation may not apply to you.

Except as provided in this warranty and to the extent permitted by law, Air Lift Company shall not be liable for any direct, special, incidental or consequential damages resulting from any breach of warranty or condition, or arising in connection with the sale, use or repair of air lift products, or under any other legal theory, including but not limited to loss of use, loss of revenue, loss of actual or anticipated profits, loss of the use of money, loss of business, loss of opportunity, loss of goodwill, and loss of reputation. Air Lift Company's maximum liability shall not in any case exceed the purchase price paid by you for the Air Lift product. Please note that some states do not allow the exclusion or limitation of incidental or consequential damages, so the above limitation or exclusion may not apply to you.

HOW TO GET SERVICE

If a defect in workmanship or materials causes your Air Lift product to become inoperable within the warranty period, before returning any defective product, call Air Lift Company at (800) 248-0892 in the U.S. and Canada (elsewhere, (517) 322-2144) to obtain a Returned Materials Authorization (RMA) number. The consumer shall be responsible for removing (labor charges) the defective product from the vehicle and returning it, shipping costs prepaid, to Air Lift Company for verification. Returns to Air Lift Company must be postage prepaid and sent to: Air Lift Company • 2727 Snow Road • Lansing, MI • 48917. You must prove to the satisfaction of Air Lift Company the date of original purchase of your Air Lift product. You must also enclose the RMA number and a return address. A minimum \$10 shipping and handling charge will apply to all warranty claims. You must also pack the product to minimize the risk of it being damaged in transit. If we receive a product in damaged condition as the result of shipping, we will notify you and you must seek a claim with the shipper.

WHAT AIR LIFT COMPANY WILL DO

If you submit a valid claim to Air Lift Company during the warranty period, Air Lift Company will, at its option, repair your Air Lift product or furnish you with a new or rebuilt product. Air Lift Company will not reimburse you for repairs or replacement parts provided by other parties. Your repaired or replacement Air Lift product will be returned to you (subject to payment of the required warranty claim shipping and handling charge) and it will be covered under the warranty for the balance of the warranty period, if any. When a product or part is replaced, any replacement item becomes your property and the replaced item becomes property of Air Lift Company. You are responsible for installation/reinstallation (labor charges) of the product.

HOW THE LAW RELATES TO THIS WARRANTY

This warranty gives you specific legal rights and you may also have other rights which vary from state to state. By this warranty, Air Lift Company does not limit or exclude your rights except as allowed by law. To fully understand your rights, you should consult the laws of your state.

SPECIFIC LOAD SUPPORT WARRANTY PERIODS BY PRODUCT LINE

LoadLifter 5000™ Ultimate.....	Lifetime Limited	WirelessAIR™	2 Year Limited
LoadLifter 5000™	Lifetime Limited	WirelessONE™	2 Year Limited
RideControl™	Lifetime Limited	LoadController™ Single and Dual.....	2 Year Limited
Air Lift 1000™	Lifetime Limited	LoadController™ I and II	2 Year Limited
AirCell™	Lifetime Limited	SmartAir™ II.....	2 Year Limited
SlamAir™	Lifetime Limited	Other Accessories	2 Year Limited

How to Get Replacement Parts

If you need replacement parts, contact the local dealer or call Air Lift customer service at (800) 248-0892. Most parts are immediately available and can be shipped the same day.

Contact Air Lift Company customer service at (800) 248-0892 first if:

- Parts are missing from the kit.
- Need technical assistance on installation or operation.
- Broken or defective parts in the kit.
- Wrong parts in the kit.
- Have a warranty claim or question.

Contact the retailer where the kit was purchased:

- If it is necessary to return or exchange the kit for any reason.
- If there is a problem with shipping if shipped from the retailer.
- If there is a problem with the price.

Contact Information

If you have any questions, comments or need technical assistance contact our customer service department by calling (800) 248-0892, Monday through Friday. For calls from outside the USA or Canada, our local number is (517) 322-2144.

For inquiries by mail, our address is PO Box 80167, Lansing, MI 48908-0167. Our shipping address for returns is 2727 Snow Road, Lansing, MI 48917.

You may also contact us anytime by e-mail at sales@airliftcompany.com or on the web at www.airliftcompany.com.

Need Help?

Contact our customer service department by calling (800) 248-0892, Monday through Friday. For calls from outside the USA or Canada, dial (517) 322-2144.

**Register your warranty online at
www.airliftcompany.com/warranty**



Thank you for purchasing Air Lift products — the professional installer's choice!

Air Lift Company • 2727 Snow Road • Lansing, MI 48917 or PO Box 80167 • Lansing, MI 48908-0167
Toll Free (800) 248-0892 • Local (517) 322-2144 • Fax (517) 322-0240 • www.airliftcompany.com

Printed in the USA
JJC-0517