

<THESE INSTRUCTIONS MUST BE GIVEN TO THE END USER>



B&W Trailer Hitches
 1216 Hawaii Rd / PO Box 186
 Humboldt, KS 66748
 P:800.248.6564
 F:620.869.9031

Call or Email us for
 Installation Support
 hitches@turnoverball.com
 bwtrailerhitches.com

See Limited Lifetime Warranty at
bwtrailerhitches.com/warranty

Turnoverball® Gooseneck Hitch Installation Instructions

MODEL 1309R

2009-2018 Dodge/Ram 1500 Trucks
 2019-2020 Ram 1500 Classic Trucks

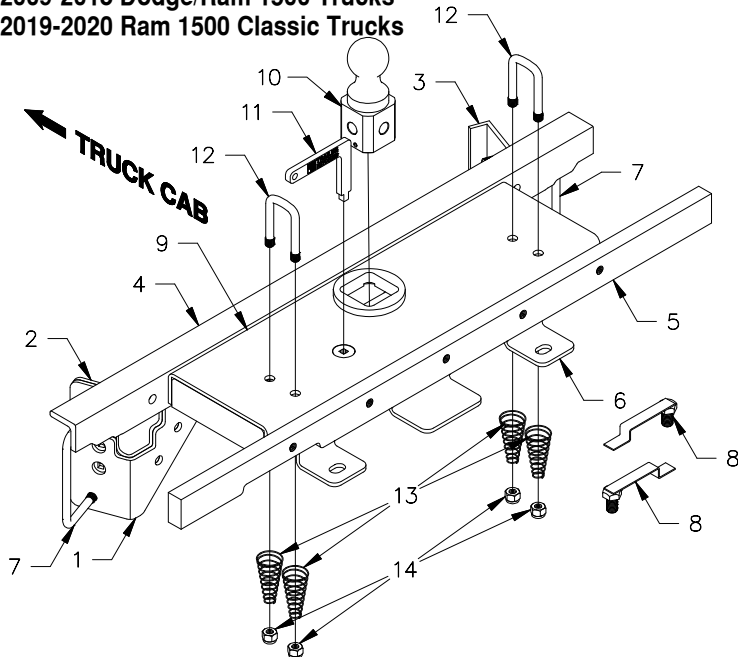

Mounting Kit Box (GNRM1309)		
ITEM	DESCRIPTION	QTY
1	Outside Driver Side Plate	1
2	Inside Driver Side Plate	1
3	Passenger Side Plate	1
4	Front Cross Member	1
5	Rear Cross Member	1
6	Rear Brace	1
7	1/2" X 5-1/2" X 4-1/4" U-Bolt	2

Center Box (GNRC909)		
ITEM	DESCRIPTION	QTY
9	Center Section	1
10	2-5/16" Ball	1
11	Latch Pin Handle	1

Mounting Kit Bolt Bag		
ITEM	DESCRIPTION	QTY
8	Bolt Guide Assembly	2
	1/2" X 1-1/2" Cap Screw	9
	1/2" X 2-1/4" Cap Screw	4
	1/2" Lock Washer	17
	1/2" Flat Washer	13
	1/2" Finish Nut	12
	5/8" Serrated Flange Nut	2

Safety Chain Kit Bolt Bag		
ITEM	DESCRIPTION	QTY
12	1/2" U-Bolt	2
13	Conical Springs	4
14	1/2" Lock Nut	4
	5/16" X 3/4" Carriage Bolt	1
	5/16" X 3/4" Cap Screw	1
	5/16" Lock Nut	1

NOTICE: At this time no accessories, including the model RVK3000 RV Companion 5th wheel hitch, the RVK3400 slider, and the RVK3405 slider, will work with this model of Turnoverball **except:** 4" Dodge Hitch Extender (part# GNXA4685) & RV Companion 5th wheel hitch (model RVK3500), with special socket post.

⚠ WARNING

Failure to comply with the safety information in these instructions could result in serious injury or death.

- ⚠ Read all installation and operating instructions along with all labels before using this product.
- ⚠ Adding components such as a Turnoverball hitch to the chassis of any vehicle can be hazardous. There is potential for unexpected combustion of fuel, electric shock, burns, shifting or falling of unstable vehicle, damage to vehicle, injury from tool usage and many other hazards. This installation must be completed by someone who is aware of the hazards involved. This person must be knowledgeable of proper safety procedures for a vehicle modification of this nature, and for usage of the equipment required to perform the installation.
- ⚠ Without proper knowledge, towing can be a dangerous activity. Understand all the risks involved with towing before proceeding. For information on towing safety, see "**The Trailer Handbook: A Guide to Understanding Trailer and Towing Safety**" from the National Association of Trailer Manufacturers, www.NATM.com and your trailer manufacturer's owner's manual.
- ⚠ Do not exceed tow or tongue rating of coupler, tow or tongue rating of hitch, or tow or weight ratings of truck or trailer. See vehicle and trailer manufacturer information for ratings. Exceeding these ratings may cause damage to towing components or loss of attachment between the trailer and truck.
- ⚠ Do not modify this product in any manner. Doing so could alter its integrity and lead to a loss of attachment between the trailer and the tow vehicle.
- ⚠ Additional caution must be used when towing a wedge car trailer. Towing stability greatly depends on keeping the center of gravity as low as possible. Load heavy cars over the axles. Never tow with a single car on the front of the trailer. When towing a wedge car trailer, never exceed speeds that are reasonable for the roadway conditions (e.g. turns, going around a curve, etc.). Failure to account for proper trailer center of gravity and speeds that are reasonable for the roadway conditions may cause damage to the truck, trailer, towing components, and loss of attachment between the truck and trailer.
- ⚠ This product was designed to fit vehicles in their original, "as manufactured" condition. Compatibility with vehicles having replacement parts, or other modifications is not guaranteed. Inspect vehicle for modifications before installation of this product.
- ⚠ The Turnoverball hitch comes equipped with a 2-5/16" ball. Trailers towed with the ball provided must have a 2-5/16" coupler. Towing with a larger coupler could cause loss of attachment between the trailer and the tow vehicle.
- ⚠ A visual inspection of the hitch should be performed before each time you tow. Regularly check that all pinned connections are secure, and that all bolted connections are at the correct torque specification. Check for cracks or damage to the hitch. Do not tow with the hitch if cracks or damage outside of normal wear is found. Towing with a hitch that has cracks or damage could result in damage to the tow vehicle, trailer, towing components or loss of attachment between the tow vehicle and trailer.

PREPARE TO INSTALL

NOTE: Remove all parts from the packaging and familiarize yourself with all the parts and tools required. Use the parts list on the front page to verify that all parts and hardware are present.

Installation of the Turnoverball hitch requires several common tools and a few specialized tools. Below is a listing of equipment used during a typical installation.

TOOLS REQUIRED

- Impact wrench or ratchet with 3/4" socket.
- 1/2", 3/4" & 15/16" Box end wrench
- Marking tool (pencil or permanent marker)
- 4" hole saw
- Drill with 1/2" bit
- Ear protection
- Pry Bar
- Lifting Device
- Flashlight
- Eye protection
- Torque wrench
- Tape measure
- Pilot hole Bit

1. **Determine cab clearance.** The Turnoverball hitch is designed so that the ball can be inverted and stored below the surface of the truck bed while not in use. The ball location is determined by this design feature and the truck geometry. Measure the trailers to be towed with this hitch to be sure that the location of the 2-5/16" ball listed in Step 5 will provide ample turning clearance between the nose of the trailers and the cab of the truck.

WARNING: Cab clearance on short bed trucks is very limited when towing certain trailers. Failure to ensure that there will be adequate clearance, may result in significant property damage, or serious injury.

2. **Remove the spare tire (optional).** Following the vehicle manufacturer's instructions, remove the spare tire. This will provide easier access to the area where the hitch will be installed. Remember to replace tire when installation is completed.

3. **Position the vehicle.** Installation of the hitch requires the installer to be under the truck bed in the area of the rear axle. Lifting the vehicle makes this area more accessible to the installer, and improves the installation process.

WARNING: Lift vehicle using only equipment designed for lifting and positioning vehicles for service. Failure to do so may result in property damage, serious injury, or death.

4. **Prepare a lifting device (optional).** The purpose of the device is to safely hold the hitch in position during part of the installation. See Figure A1 for an example. A simple mechanical lifting device is available for purchase from B&W.

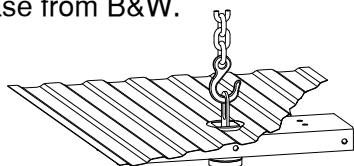

Figure A1.

5. **Mark the hole locations.** Begin by marking the locations for the 4" diameter and 3/4" diameter holes in the truck bed floor. To mark the location of the 4" hole, measure from the back of the truck bed floor by hooking a tape measure over the back of the sheet metal and marking the floor with the length specified for your bed size and centered between the wheel wells. The 3/4" hole will be offset from center on the driver side of the bed. Locate the mark for the 3/4" hole with the length specified for bed size from the back of the truck bed floor, and 4-3/4" from the center of the 4" hole, see Figure A2. The locations of these holes are critical to the installation of the hitch, so measure, mark, and saw carefully.

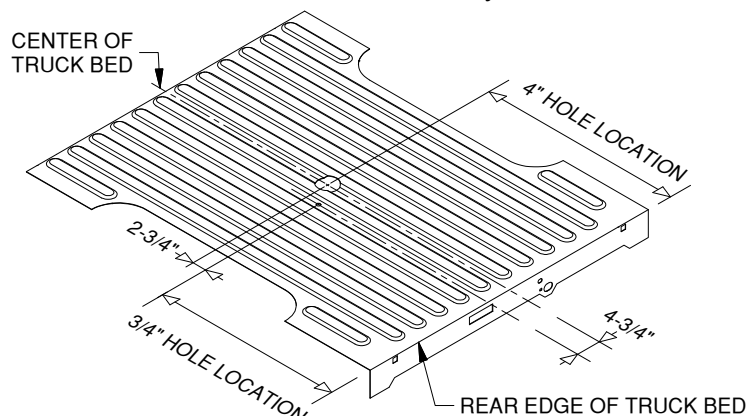

Figure A2.

4" HOLE LOCATION

8' LONG BED - 42-1/8"

SHORT BED (BEDS LESS THAN 8' LONG) - 40-1/8"

3/4" HOLE LOCATION

8' LONG BED - 39-3/8"

SHORT BED (BEDS LESS THAN 8' LONG) - 37-3/8"

IMPORTANT: The hitch is designed to install only at the described location. Failure to place the 4" and 3/4" holes precisely may result in added difficulty during installation or property damage.

IMPORTANT: If the bed is equipped with a plastic bed liner, the hole may be cut through both the liner and the bed. However, the center of truck bed may be more difficult to locate, and the mark may be harder to hit if the liner slides or moves. Failure to cut the hole in the correct location may adversely affect the install and may result in property damage.

IMPORTANT: If your truck has a spray-in bed liner you will need to take this into account when you are measuring, and add the thickness of the applied liner that has been sprayed over the end of the bed.

6. **Cut the holes.** Cut the hole in the marked location using a 4" and 3/4" hole saw or by marking out the holes and using a saber saw equipped with a metal cutting blade. Remove any burrs created while cutting hole.

⚠ WARNING: Turnoverball hitch components are heavy and may be cumbersome to handle. Failure to use proper lifting techniques and caution when handling these items could result in serious injury.

⚠ WARNING: Most trucks have fuel lines, brake lines, electrical wires or other vehicle systems located along the frame rails or in the general area where B&W Turnoverball hitches install. Carefully examine the locations of these systems before installation. Make certain that these are not damaged during positioning hitch components, drilling holes, or tightening fasteners. Damage to these systems may result in property damage, serious injury, or death.

INSTALL REAR CROSS MEMBER

- 1. Remove the plastic wheel fenders (optional).** Remove the plastic wheel fenders to allow better access to hitch installation area. Re-install fenders when installation is complete.
- 2. Relocate wiring and vent tube.** A wiring harness that must be relocated runs along the top of the driver's side frame and the frame cross member that is just behind the axle. The harness is secured to the top of the cross member by plug fasteners. Pull each of the fasteners, as needed, to move the harness so that it lays in the notch of the rear cross member and does not get pinched. The vent tube coming out of the rear axle is clipped onto the same frame cross member. Remove the vent tube, clip and all. Allow this to hang during installation. It will be relocated after the hitch is installed.
- 3. Place the rear cross member.** The rear cross member is the 2" x 1" bar with the threaded holes. The cross member will be installed from the passenger side, just in front of the rear tire. Insert the cross member between the frame and the top suspension control arm with the notch machined into the cross member going first and facing the rear. Slide the leading end of the cross member above the exhaust and over the frame of the truck on the driver side while moving that end toward the rear, see Figure B1. As the leading end gets to the driver side, raise the opposite end of the cross member up until both ends of the cross member can be positioned over the top of the frame with the cross member laying flat and the notch still facing the rear, see Figure B2.

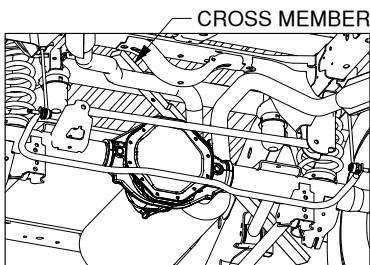

Figure B1: View under bed looking from rear towards the axle.

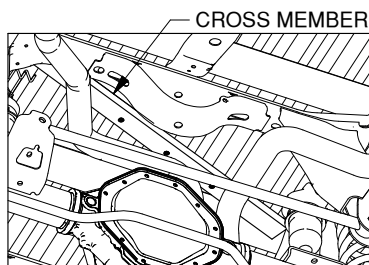

Figure B2: View under bed looking at area above axle.

- 4. Position the rear cross member.** Adjust the cross member so that it is parallel to the axle and slide it toward the rear of the truck until it is over the frame cross member where the wiring harness was attached. Rotate the cross member from flat to vertical so that the notch on the driver side of the cross member is down, see Figure B3. This notch provides clearance for the wiring harness and an exhaust bracket that is present on models that have dual exhaust. Slide the cross member rearward as far as possible while making sure that the wiring harness does not get pinched or smashed. The cross member will rest on the frame and should be suspended just above the frame cross member.

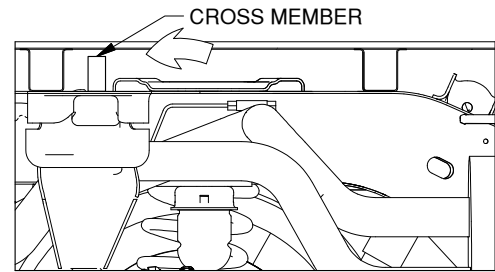

FIGURE B3: Cut-away view of under bed looking from passenger side of truck.

INSTALL CENTER SECTION

- 1. Position the center section.** Position the center section so that the 4" diameter raised area of the center fits into the 4" diameter hole in the truck bed while the 3/8" square hole is centered under the 3/4" diameter hole in the truck bed. When installed the round receiver will be almost directly above the axle of the pickup. If the pickup is equipped with dual exhaust the installation is more difficult. From behind the rear axle and with the bottom side of the center facing the passenger side of the truck, send the end of the center without the spring over the axle first, see Figure C1. Send the lead end of the center toward the front of the truck and to the passenger side far enough so the end of the center toward the rear of the truck will clear the exhaust, see Figure C2.

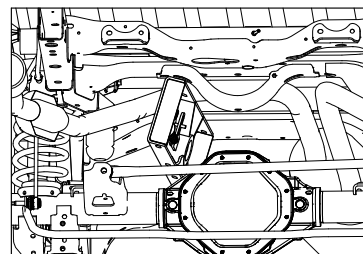

Figure C1: View under bed looking from rear towards the axle

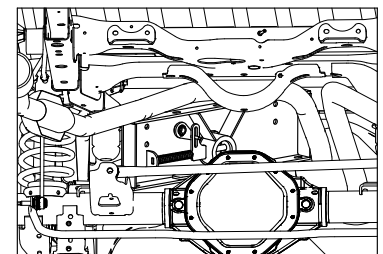

Figure C2: View under bed looking from rear towards the axle

Continued on next page...

2. **Install the center section.** Once the hitch is clear of exhaust, rotate, and lift it so that the 4" raised area is toward the bottom of the truck bed. Slide the center rearward over the exhaust until the 4" diameter raised portion is in the 4" diameter hole in the truck bed while the 3/8" square hole is centered under the 3/4" diameter hole in the truck bed, see Figures C3 through C5. If available, an overhead lifting device can be attached to the latch pin of the center section at this time to apply upward pressure on the center, holding it in place. Slide the rear cross member forward until it makes contact with the center section. Line the holes in the rear cross member up with the slots in the center. Attach the center to the rear cross member using the two outside slots and middle slot in the center. Thread a 1/2" x 1-1/2" long bolt into each threaded hole in the rear cross member adding a lock washer, and flat washer to each connection. Hand tighten hardware at this time. Do not fully tighten.

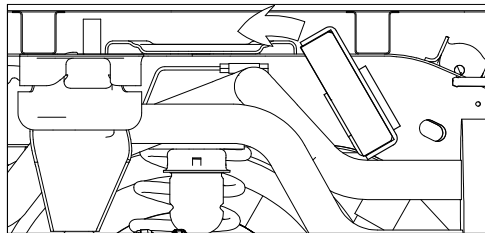

Figure C3. (Cut-away view under bed)

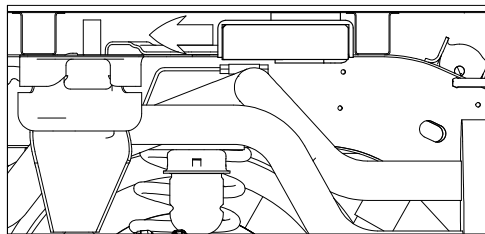

Figure C4. (Cut-away view under bed)

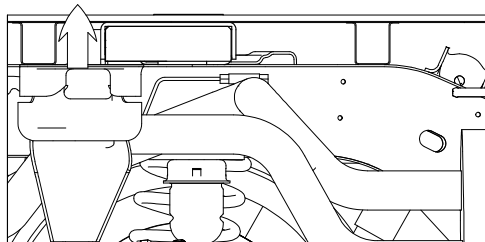

Figure C5. (Cut-away view under bed)

INSTALL FRONT CROSS MEMBER

1. **Position the front cross member.** The front cross member is the 2" x 2-1/2" angle. Install the cross member from the passenger side in front of the rear tire, see Figure D1. Move the cross member so that it spans the frame and sits in an upside down "V" position with the holes toward the rear of the truck. Slide the cross member rearward to the center section.

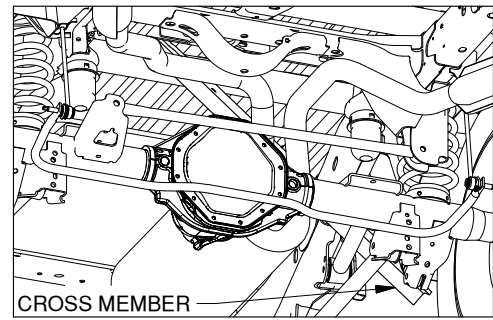

Figure D1: View under bed looking at area above axle.

2. **Install the front cross member.** Center the cross member in the truck so that the holes in the cross member will line up with the slots in the center. Using an adjustable wrench or other means, stand the cross member up so that leg of the angle with the holes is vertical. Slide the cross member back against the center, see Figures D2 and D3. The wiring harness should be off the top of the frame to the inside. Make sure the harness does not get pinched between the frame and the hitch parts. Attach the center and the cross member with two 1/2" x 2-1/4" long bolts with flat washers in the two center holes only. The bolt heads must be toward the rear of the truck. It may be necessary to retract the latch pin to make room to insert the bolts into the center section. Add a lock washer, and finish nut to both bolts and hand tighten. Do not fully tighten at this point.

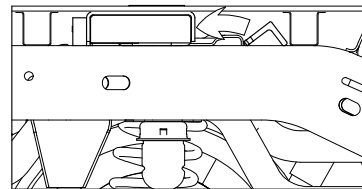

Figure D2: (Cut-away view)

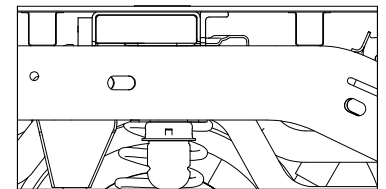

Figure D3: (Cut-away view)

INSTALL SIDE PLATES

1. **Place the U-bolts.** Place one U-bolt in front of each coil spring around the pickup frame as shown in Figure E1. To ease installation of the side plates, start with the U-bolts pulled back from the frame so that the ends of U-bolts are flush with the wall of the tubular frame, see Figure E2.

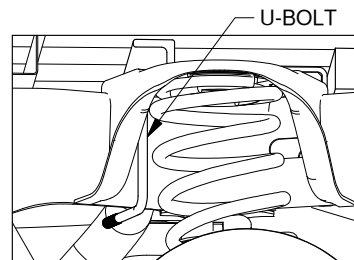

Figure E1: View of driver side suspension spring (Tire and wheel well shroud not shown)

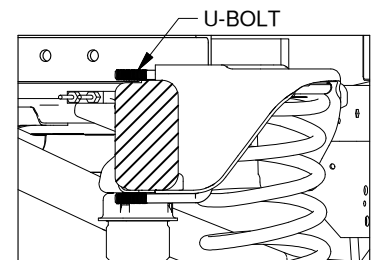

Figure E2: Cutaway view of suspension spring area looking towards the rear of the truck

Continued on next page...

2. **Install passenger side plate.** Locate the Passenger side side plate. Position the side plate so that the two round holes match up to the U-bolt on the passenger side and push the U-bolt into the holes, see Figure E3. Secure the side plate and U-bolt with lock washers and nuts. Attach this side plate to the front cross member and center using a 2-1/4" long bolt through the center, cross member and side plate along with a lock washer, two flat washers, and a finish nut. Finish attaching the side plate by placing another 1/2" x 1-1/2" long bolt through the cross member and the side plate adding a flat washer, lock washer, and finish nut. Hand tighten these connections.

NOTICE: If the vehicle is equipped with a four corner air suspension, the air line along the passenger side of the frame will need to be re-located around the passenger side plate. After the U-bolt is installed, loosen the air line by pulling it away from the frame so that the side plate can be installed between the air line and the frame. Next, attach the side plate as described above. After the side plate is secure, pull the airline down and under the side plate. Make sure the airline is in resting in a location that cannot be pinched or damaged.

3. **Install the driver side plates.** The two side plates that are left will be combined to secure the hitch to the frame on the driver side. Using the slot provided, maneuver the outside side plate around the brake lines and line the holes up with the U-bolt, see Figure E4. The wiring harness may lay in this slot to prevent it from being pinched by the U-bolt, side plate, or cross member.

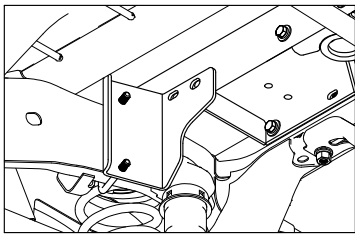

Figure E3: View of passenger side plate looking from floor up at the frame

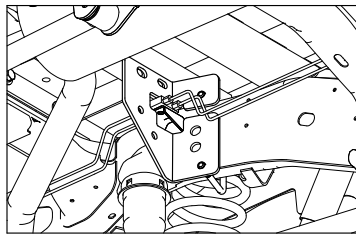

Figure E4: View of driver side plate looking from floor up at the driver side frame.

4. **Driver side plate cont.** Insert the U-bolt into the holes on the side plate just enough to hold the side plate in place. Position the inside side plate over the first as shown, see Figure E5. Insert the U-bolt into the holes of the inside side plate. Secure the side plates and U-bolt with lock washers and nuts. Fasten the two side plates together as shown using 1/2" x 1-1/2" long bolts, lock washers and finish nuts, see Figure E6. Attach these side plates to the front cross member and center using a 2-1/4" long bolt through the center, cross member and side plate along with a lock washer, two flat washers, and a finish nut. Finish attaching the side plates by placing a 1/2" x 1-1/2" long bolt through the cross member and the side plates adding a flat washer, lock washer, and finish nut. Hand tighten these connections.

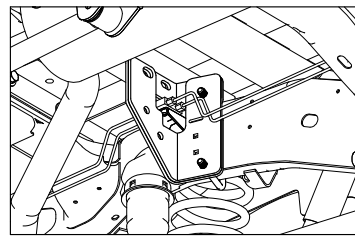

Figure E5: View of driver side plate looking from floor up at the driver side frame.

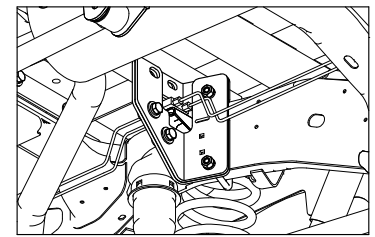

Figure E6: View of driver side plate looking from floor up at the driver side frame.

INSTALL REAR BRACE

1. **Locate the bolt guides.** Locate the two 5/8" x 1" long bolts that are welded to thin straps (bolt guides), see Figure F1.

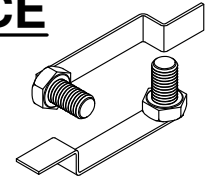

Figure F1.

2. **Position the straps.** Using the straps install the bolt guides into the frame cross member just behind the axle, see Figures F2 & F3. The straps on the bolt guides will keep them from turning.

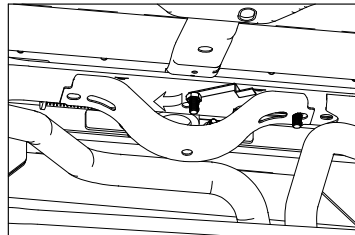

Figure F2: View under bed looking from floor to area above axle.

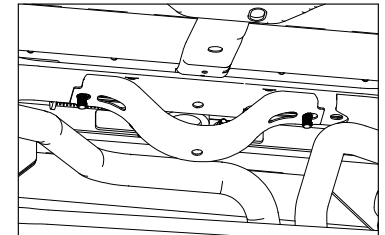

Figure F3: View under bed looking from floor to area above axle.

3. **Install the rear brace.** Position the two large slots over the 5/8" bolts of the bolt guides, see Figure F4. Attach the rear brace to the center section and the rear cross member with two 1/2" x 1-1/2" long bolts, lock washers and flat washers. Hand tighten only at this time. Using the 5/8" flange nuts, attach the rear brace to the frame cross member with the bolt guides. If the truck is equipped with dual exhaust, it may be helpful to pry the exhaust downward while installing the flange nut on the driver side bolt guide, see Figure F5.

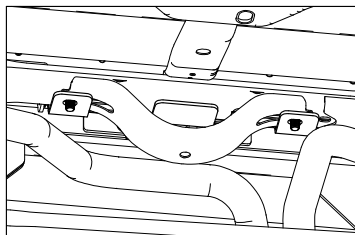

Figure F4: View under bed looking from floor to area above axle.

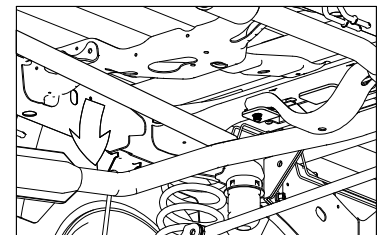

Figure F5: View under bed looking from floor to area above driver side exhaust pipe.

NOTICE: On some newer model trucks it may be helpful to lower the exhaust further by disconnecting the rear exhaust hanger. Always reconnect the exhaust hanger when installation is complete.

NOTICE: In some cases, the exhaust may lay against the 5/8" bolt guides after installation is complete. This may cause the exhaust to rattle. Please call B&W customer service for additional information including possible solutions for the hardware interference.

TIGHTEN HARDWARE

1. **Before tightening.** Make sure that the center section is tight against the bottom of the truck bed, and that the hitch is centered and square in relation to the truck frame. The 3/8" square hole in the center must be close to the center of the 3/4" hole in the truck bed.
2. Tighten the hitch hardware in the following sequence. Torque the 5/8" flange nuts to 110 ft. lbs. Be sure the rear cross member is centered across frame and that the wiring harness is not pinched then tighten the rear brace to the rear cross member and center. Tighten the center to the rear cross member. Be sure that the front cross member is centered and tighten the center to the cross member. Tighten both side plate U-bolts alternating between the top and bottom threads so that the U-bolt is secured evenly. Torque nuts on U-bolts to 40 ft. lbs. Tighten the two bolts holding the two side plates together on the driver side, then tighten the side plates to the front cross member and center. Torque all 1/2" hardware to 110 ft. lbs. except for the U-bolts.

3. **Replace the vent tube.**

Locate the axle vent tube that was disconnected from the frame at the beginning of the install. Relocate the vent by clipping the end to the frame cross member as shown, see Figure G1.

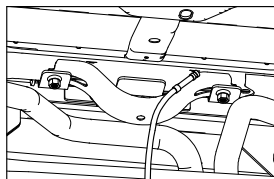

Figure G1: View under bed looking from floor to area above axle.

INSTALL SAFETY CHAIN U-BOLTS

1. **Drill the holes.** To install the safety chain brackets, it is necessary to drill four 1/2" holes through the truck bed floor. Drill the holes so that they match up with the two sets of holes on each side of the center, see Figure H1. This may be done by drilling the 1/2" holes from the bottom using the center as a guide, or by drilling a smaller pilot hole from the bottom and drilling the 1/2" holes from the top side of the bed.
2. **Install the U-bolts.** From the top side of the truck bed, drop a U-bolt in each set of holes.
3. **Add Springs.** Place a conical spring over each leg of the U-bolts and secure with a 1/2" lock nut. see Figure H2. Tighten the lock nut until the nut is flush with the end of the U-bolt.

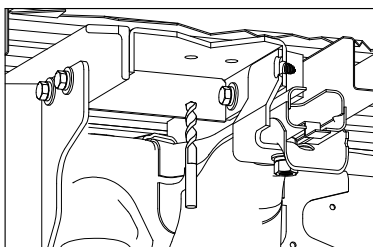

Figure H1: Cutaway view from under the bed.

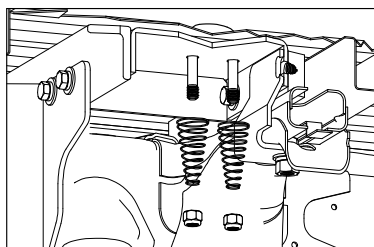

Figure H2: Cutaway view from under the bed.

PREPARE FOR TOWING

1. **Latch pin operation.** To operate the latch pin of the hitch, use the L-shaped handle provided. Insert the square end of the handle into the 3/8" square hole in the center from the top side of the truck bed. To retract the latch pin, rotate the handle counterclockwise. Place the 2-5/16" ball into the hitch receiver. Engage the latch pin by rotating the handle clockwise. Be certain the latch pin passes through the holes in the 2-5/16" ball and fully engages through the hitch receiver. This can be determined by whether or not the handle returns to its original location.

⚠ WARNING: When installed properly the latch pin will pass through the 2-5/16" ball and fully engage through both walls of the hitch receiver. Failure of the pin to engage the ball and hitch properly could result in a loss of attachment between the trailer and the tow vehicle.

2. **Lubricate 2-5/16" ball.** Apply a light coating of grease to the corners on the square shank of the 2-5/16" ball.

⚠ WARNING: Inverting the ball while hauling heavy loads may cause the ball to strike the truck's differential, drive line, or other components. Inspect the relationship between the ball and truck components to ensure the proper clearance. Failure to remove the ball when hauling heavy loads may result in property damage, injury or death. A cover to prevent debris from entering the socket while operating without the ball in place is available from B&W.

3. **Re-read front page.** Re-read all warnings on front page of these instructions. If you are not the end user, make sure that users of this product receive a copy of these instructions.