

A high-angle, top-down photograph of a person wearing a blue long-sleeved shirt, white shorts, and a brown corduroy cap, working on a silver metal towing device mounted in the bed of a dark-colored truck. The person is leaning over the device, which has a large circular component and various mechanical parts. The truck bed has a textured, ribbed surface. The overall scene is set outdoors on a gravel surface.

# COMPANION SLIDER

YOUR TOWING ADVENTURE BEGINS

An aerial photograph of a deep, rugged river canyon during sunset. The sky is filled with warm, golden light, and the canyon walls are illuminated with shades of orange and red. A river flows through the center of the canyon. The BW logo is prominently displayed in the middle of the image.

**BW**

*TOWING ADVENTURE*



# DON'T WORRY YOUR HITCH WAS MADE RIGHT HERE.

You've got a lot riding on your hitch and the only thing keeping your truck and your trailer connected are those relatively small pieces of engineered steel. The hitch matters to your safety and the safety of our roads.

That's why we treat the manufacture of your trailer hitch with the respect it deserves. For one, we insist on American-made steel, like the sheet steel we buy from U.S. Steel out of Gary, Indiana or the round bar that becomes the gooseneck ball made at a mill in Norfolk, Nebraska. Where the strength and flexibility of the steel can mean life or death, we trust the U.S. steel mills with their finely controlled processes and specifications we can trust.

A hitch is only as good as the welds holding it together. We insist on making those welds under our roof. And the hard-working, skilled Americans that make the welds do so according to the American Society for Testing and Materials Welding Standards.

Thank you for putting your trust in us.

**- Joe Works**

**WELCOME TO THE FAMILY.**

---

**YOU MADE A GREAT CHOICE.**



# SIMPLE GOALS:

MAKE IT SAFE,  
MAKE THE RIDE SMOOTH,  
AND MAKE IT REMOVABLE.



Cam action latching handle  
for easy release, even when  
parked on unlevel sites

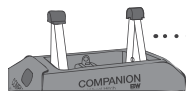

Polyurethane bushings  
provide a quiet, rattle-free  
towing experience

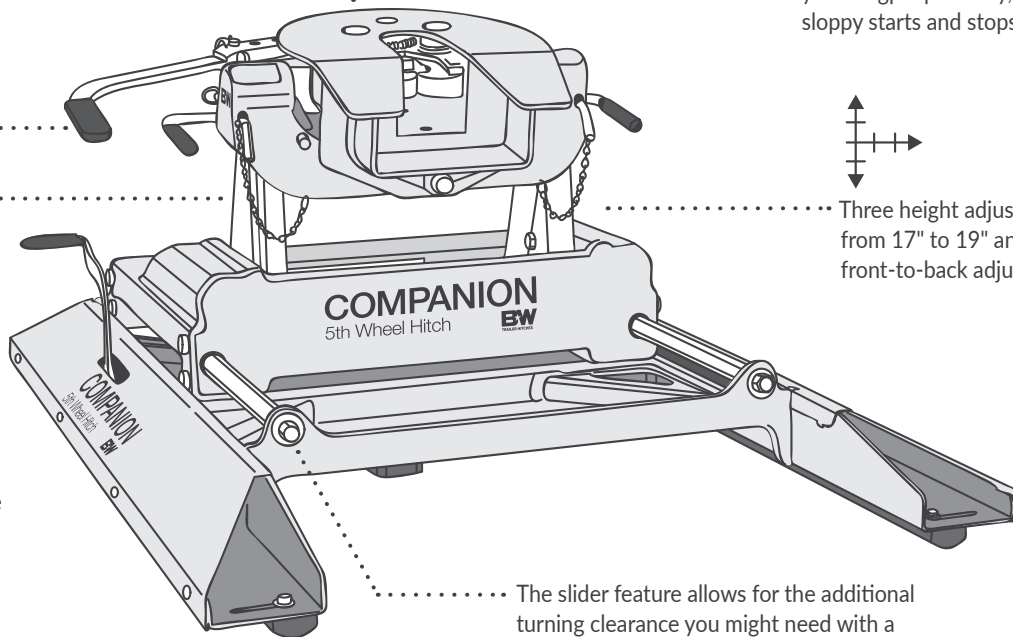

Fully articulating head  
allows front-to-back and  
side-to-side pivoting

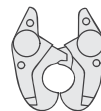

1" thick, wrap-around jaws fit  
your kingpin perfectly, eliminating  
sloppy starts and stops

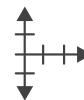

Three height adjustments  
from 17" to 19" and 2" of  
front-to-back adjustment

The slider feature allows for the additional  
turning clearance you might need with a  
short-bed truck.

# THE B&W DIFFERENCE

Our jaws are a full inch thick cast material and the left and right jaw are machined together to create a precise connection to your kingpin. Then the jaws are wired together, plated, and assembled as a pair. Learn more about this process on the B&W Trailer Hitches' YouTube channel.

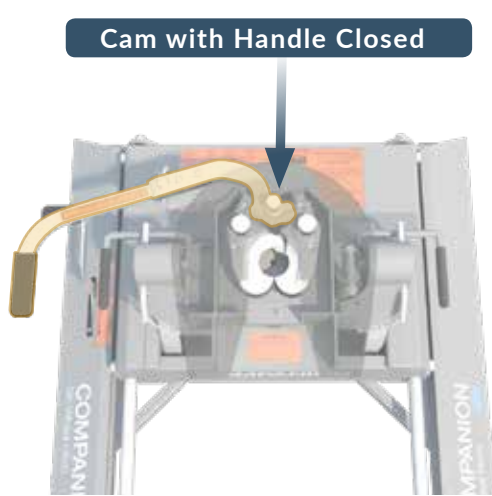

We designed our jaws and handle to work with a cam mechanism. When the handle is pinned closed, the cam keeps the jaws from opening.

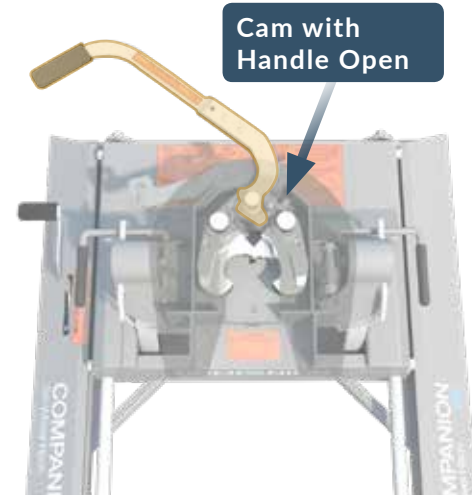

When the handle is open the cam allows the jaws to open, **even if you are in a bind** because of unlevel ground. If the handle is open, you may go ahead and drive out of the jaws. They will open as you pull away.

# ABSORBING THE SHOCK

The Companion allows side-to-side movement and articulation when you are maneuvering or on uneven ground.

The shock absorber, located on one side of the coupler, cushions that movement and allows gentle side-to-side movement without the slamming. Sit back and enjoy the ride.

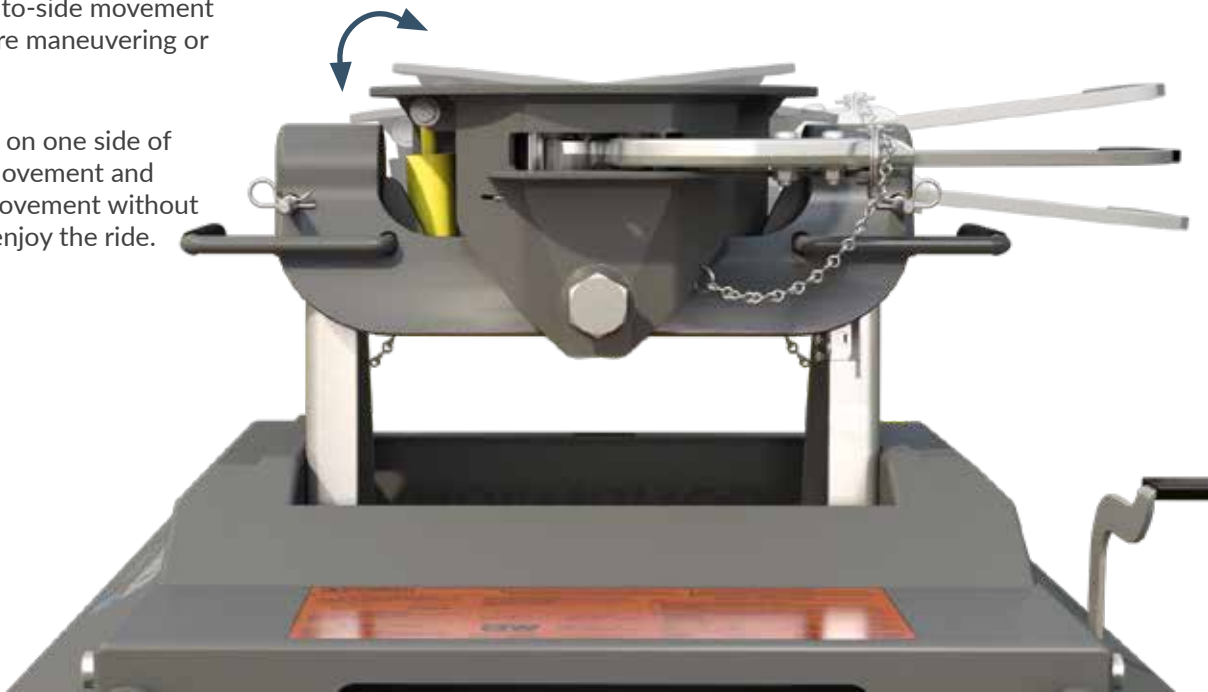

## JUST HOW TIGHT ARE OUR PROCESSES?

Machining on the jaws must be  $\pm .002$  of an inch. (A piece of paper is about twice that thick.)

# ADJUST ARMS FOR PROPER CLEARANCE





## INSTALLING PIVOT ARMS

Mount the pivot arms using one of the six different locations illustrated. These six locations allow flexibility in coupler height (vertical adjustment) and distance from the cab (horizontal adjustment). Choose a location so that your trailer will be as level as possible.

### WARNING! - DO NOT USE A WEDGE.

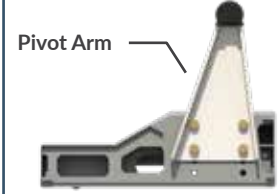

Preventing the kingpin from rotating within the jaws of the Companion coupler with a wedge, or any other device, such as Reese Sidewinder® or Reese Revolution®, could result in property damage, serious injury or death.

		Horizontal Adjustment	
		FORD/GM PUCKS	RAM PUCKS
		Kingpin 3" in front of axle	Kingpin 1" in front of axle
		Kingpin 2" in front of axle	Kingpin over axle
		Kingpin 1" behind post	Kingpin 3" behind post
Vertical Adjustment	Highest Position (19")		
	Medium Position (18")		
	Lowest Position (17")		





## **WATCH YOUR CAB**

Check that you know how sharply you can turn before encountering your cab with your fifth wheel. There are several factors that affect this angle including: the pin box location, the width of trailer, and the shape of the trailer nose.



## **WATCH YOUR BED SIDES**

Check for clearance between your fifth wheel and the sides of your truck bed. Allow several inches so that uneven ground doesn't cause contact. Adjust the Companion to a higher position or your kingpin (if it is adjustable) to a lower position to affect this distance.

# INSTALLING THE SINGLE POINT COMPANION SLIDER

1. Ensure the slider base handle is in the locked position. Disengage the latch pin in the wheel well of the driver's side of the truck by pulling toward you and then to the left.

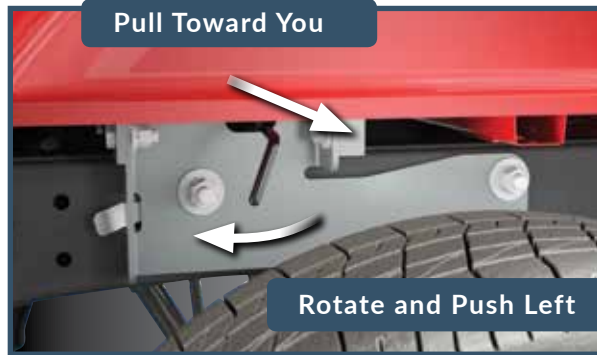

2. Remove the ball or plug from the receiver in the bed. Adjust the plastic feet for your bed ribs. Then place the base, with the post installed, in the receiver. Engage the latch pin fully.

Place Base in Receiver

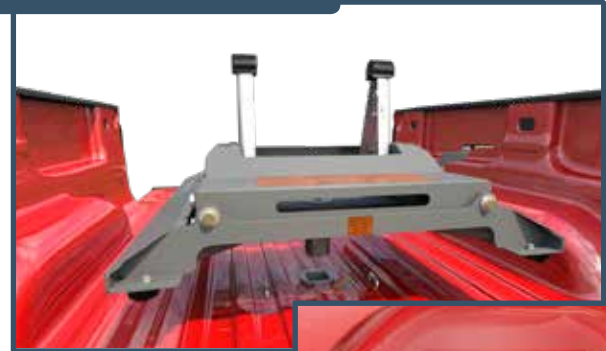

Re-engage the latch pin making sure the pin goes all the way through the post.



3. Tighten the drawdown bolt on the top of the square post to 80 ft-lbs.

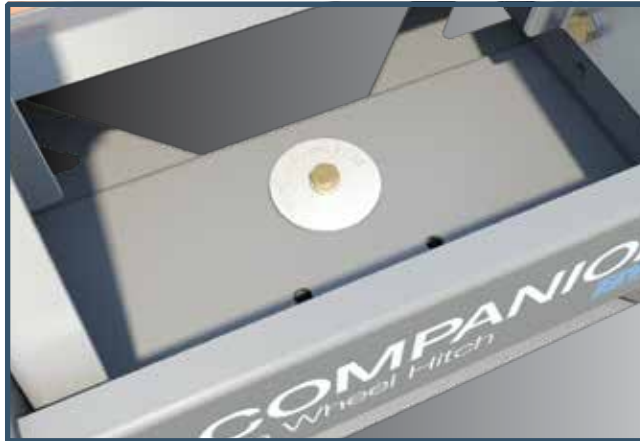

4. Place the coupler on the pivot arms and pin in place.



Place the Coupler on Pivot Arms

# REMOVING THE SINGLE POINT COMPANION SLIDER

1. Ensure the slider base handle is in the locked position. Unpin and remove the coupler head.



2. Loosen the drawdown bolt.

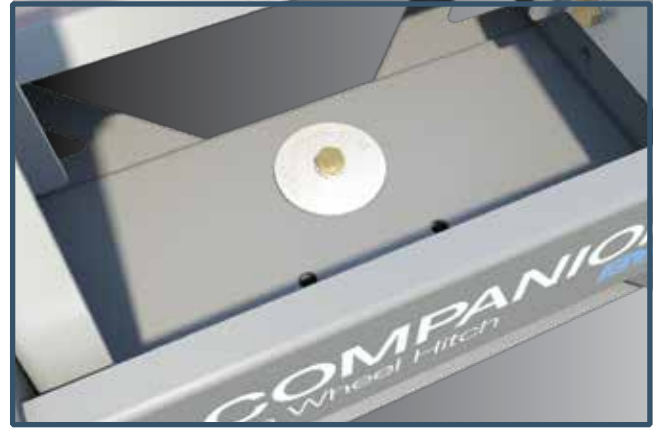

- 3.** Disengage the latch pin in the driver's side wheel well by pulling towards you and then to the left.

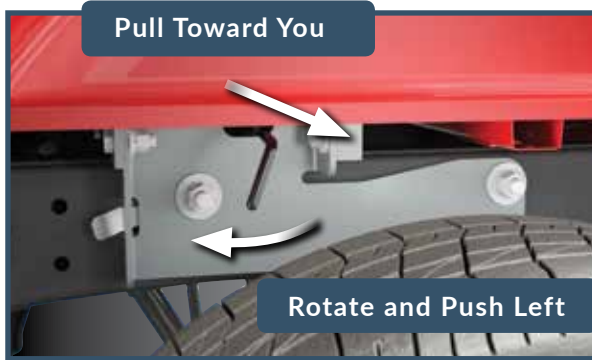

- 4.** Remove the base. Use the ball, in the inverted position, to fill the receiver hole when not towing.

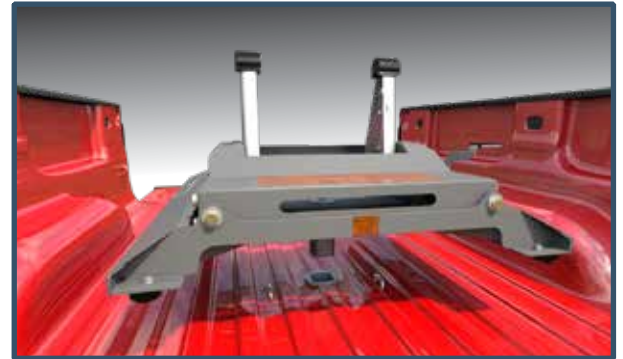

# INSTALLING THE OEM COMPANION SLIDER

1. Ensure the slider base handle is in the locked position. Remove the latch pins from each handle and rotate the handles out. Place the Companion base over the attachment points and carefully lower it until the latch cams pass through the floor and the base rests flat against the top of the attachment points.



2. Once the base is in place, turn each of the latch handles so the base is drawn firmly down onto the attachment points. You should feel some resistance with turning the handles as the base is drawn down. If any of the handles will not close or if they rotate freely with no resistance, the tension on the latch handles will need to be adjusted.



Place Base in Receiver

**If your handle needs tension adjustment.** With a pair of needle nose pliers, un-bend and remove the cotter pin installed at the top of the latch cam. Then adjust the height of the castle nut.

**To loosen the latch handle** (handle is difficult to rotate or cannot be closed) rotate the castle nut counter-clockwise (loosen) with a 15/16" wrench or socket.

**To tighten the latch handle** (handle rotates without any resistance) rotate the castle nut clockwise (tighten) with a 15/16" wrench or socket.

Use trial and error to find the correct latch tension for each attachment point. After the tension is set, replace the cotter pin and re-bend the ends. You may have to rotate the castle nut slightly to allow the cotter pin to pass through.

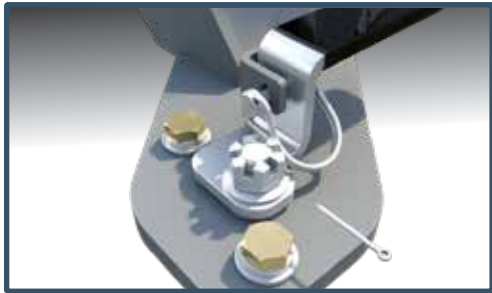

3. With the base firmly held down and each latch handle closed, replace the latch pins removed in step one. Place the coupler on the pivot arms and pin in place.



Place the Coupler on Pivot Arms

# REMOVING THE OEM COMPANION SLIDER

1. Ensure the slider base handle is in the locked position. Unpin and remove the coupler head.



2. Remove the latch pins from each of the handles.





- 3.** Turn latch handles to the open position.



- 4.** Lift the base straight up and out of the attachment points.



# KNOW BEFORE TOWING

Your Companion Slider is rated to tow 20,000 lbs. It is important to learn your manufacturer's weight limits (truck, fifth wheel, and hitch). Detailed instructions for comparing these weight limits to the actual weights of your set-up are found on the next few pages.

Truck manufacturers give their trucks specific ratings after extensive testing. Tow ratings are based on the capacity of a truck's engine, transmission and brakes to safely handle the weight of a loaded trailer. For Gross Weight Ratings, the truck's tires, frame, and suspension must be able to bear the load.

Even though your Companion Slider fifth wheel hitch is rated to tow 20,000 lbs., never exceed your truck's weight ratings.

All of our hitches are tested for both strength and durability according to SAE J-2638, the latest standard for fifth wheel and gooseneck hitches.



Without proper knowledge, towing can be a dangerous activity. If you are new to towing, we recommend

***"The Trailer Handbook:  
A Guide to Understanding  
Trailer and Towing Safety"***

from the National Association of Trailer Manufacturers. This booklet is available by going to [NATM.com](http://NATM.com).

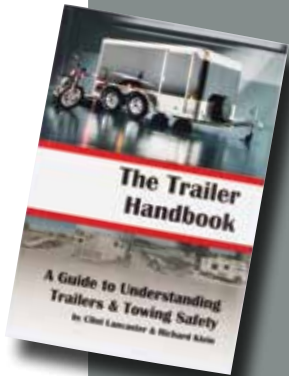



# FINDING MANUFACTURER WEIGHT LIMITS

Locate your **Gross Vehicle Weight Rating (GVWR)**.

This is the maximum allowable weight of the fully loaded vehicle.

You can find this, most likely, on the sticker inside your driver's side door.

**GVWR**

You should also locate your **Gross Combined Weight Rating (GCWR)**

from your truck manufacturer. This is the maximum allowable weight of the tow vehicle and the loaded trailer including all cargo and passengers.

Find this in your owner's manual or by calling your truck dealer.

**GCWR**

And finally, locate your **Max Tow Rating**.

It is sometimes located in the truck owner's manual or look for it at [trailerlife.com/trailer-towing-guides](http://trailerlife.com/trailer-towing-guides).

**Max Tow Rating**

B&W recommends that your **Vertical Towing Weight Rating (VTWR)**

for your hitch be no more than 25% of your truck's Max Tow Rating.

Make this calculation:  $\text{Max Tow Rating} \times .25 = \text{VTWR}$

**VTWR**

Once you have located your truck manufacturer's weight ratings, transfer them into the corresponding boxes on the next two pages.

# FINDING YOUR ACTUAL WEIGHTS

Take your loaded truck and loaded trailer to a scale at a truck stop, quarry or material supply center. For a small fee you can weigh your tow vehicle and trailer on their scale.



	MUST BE MORE THAN	
--	-------------------	--

**GVWR** \*

*your GVW*

## 1. Find your GVW (Gross Vehicle Weight)

Weigh just your truck with a full tank of gas, all your passengers and items in the cab and truck bed with your trailer loaded and attached, but not on the scale.

Do Not Exceed Your Truck Manufacturer's **GVWR**



	MUST BE MORE THAN	
--	-------------------	--

**GCWR** \*

*your GVW*

## 2. Find your GCW (Gross Combined Weight)

Weigh your fully loaded truck and trailer including all cargo, a full tank of gas and passengers.

Do Not Exceed Your Truck Manufacturer's **GCWR**

\* Transfer Manufacturer's Ratings from previous page.



$$\boxed{\phantom{00000}} - \boxed{\phantom{00000}} = \boxed{\phantom{00000}}$$

*your GCW*
*your Truck Weight*
*your Towing Weight*



	MUST BE MORE THAN	
--	-------------------	--

**MAX TOW RATING** \*

*your Towing Weight*

$$\boxed{\phantom{00000}} - \boxed{\phantom{00000}} = \boxed{\phantom{00000}}$$

*your GVW*
*your Truck Weight*
*your VTW*



	MUST BE MORE THAN	
--	-------------------	--

**VTWR** \*

*your VTW*

### 3. Find your **Towing Weight**

Weigh your loaded truck without the trailer attached. This is your truck weight.

Subtract your **Truck Weight** from your **GCW**. This is your towing weight.

### 4. Find your **VTW** (Vertical Tow Weight) also known as Tongue Weight

Subtract your **Truck Weight** from your **GVW**.

## IMPORTANT!

Even though you may be under your vehicle's Max Towing Rating, when your Gross Vehicle Weight (GVW) goes up, (more passengers, more cargo) your ability to tow the Max Towing Rating may not be possible, because:

**THE GROSS COMBINED WEIGHT RATING (GCWR) MUST NOT BE EXCEEDED.**

# ATTACHING YOUR TRAILER

1. Remove the coupler cam handle safety pin and use the cam handle to open the coupler jaws.

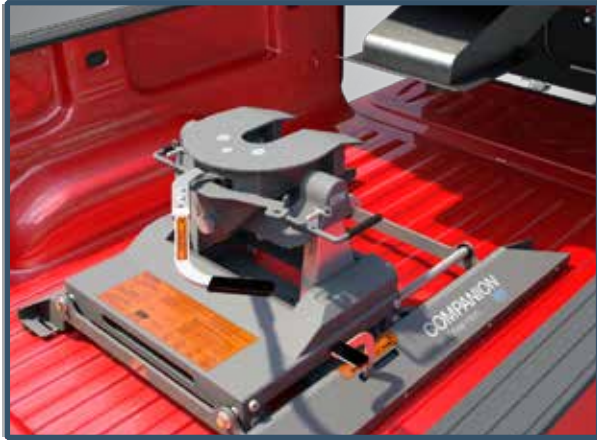

2. Adjust the height of the fifth wheel trailer using the jack so that the kingpin plate is slightly lower than the top of the coupler.
3. Back the truck towards the trailer, centering the trailer's kingpin in the coupler, until the kingpin has engaged the jaws.



4. Ensure that the coupler cam handle has completely closed and insert the cam handle safety pin through the cam handle and the coupler.



5. Hook up brake and lighting connections before towing.

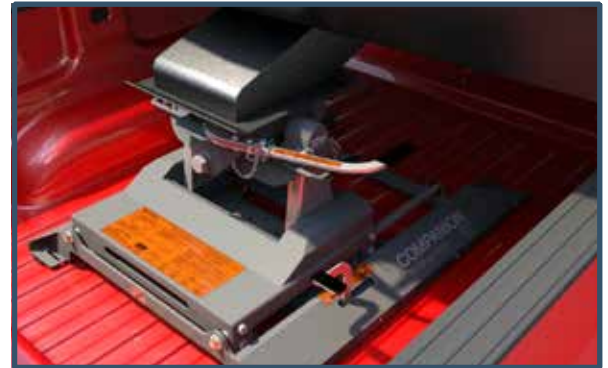

# CONDUCT A SAFETY TEST

Before towing, you should conduct a safety test to make certain that you are properly hitched.

1. Place the truck in 'park', and put the emergency brake on.

The trailer should have wheels blocked:



The trailer's landing gear should be firmly on the ground, supporting the weight of the trailer:

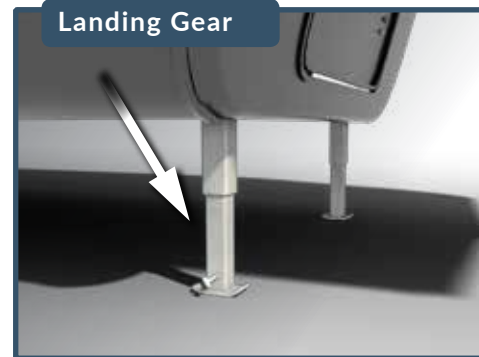





- 2.** Make sure that no one is between the truck and the trailer. Release the emergency brake and apply the trailer brakes.
- 3.** Try to pull the trailer forward with the truck. If the trailer is properly hooked up, the wheel blocks and trailer brakes should not allow the truck to move forward.
- 4.** If the trailer is not hitched correctly, the truck will separate from the trailer. However, with the landing gear resting firmly on the ground, it will support the trailer and not allow it to drop or fall on the truck sides.



# MOVING YOUR SLIDER TO THE MANEUVERING POSITION

1. While the trailer is coupled, set the trailer brakes and/or chock the trailer wheels.
2. Pull the handle towards the rear of the truck to move it to the unlocked position.
3. Pull the truck forward slowly until the handle falls into the locked position.
4. Release the trailer brakes, un-chock the trailer and maneuver the trailer as needed.

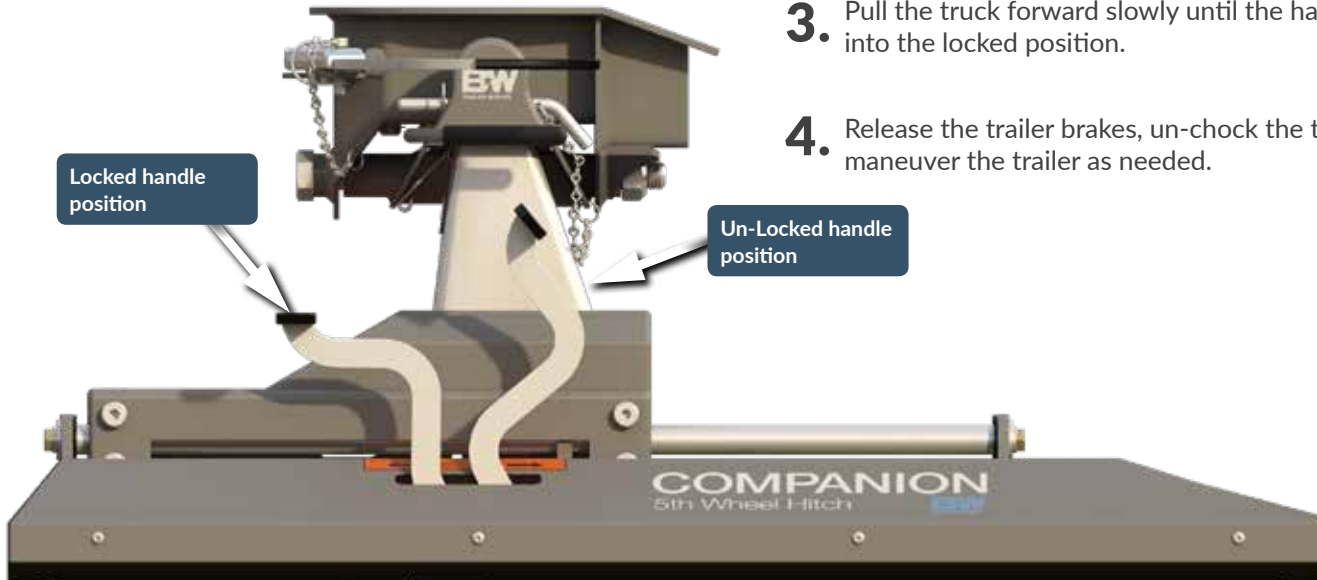

# MOVING YOUR SLIDER TO THE TOWING POSITION

- 1.** Once the trailer is satisfactorily positioned, set the trailer brakes and/or chock the trailer wheels.
- 2.** Pull the handle towards the rear of the truck to move it to the unlocked position.
- 3.** Move the truck slowly in reverse until the handle falls and is in the locked position.
- 4.** Release the trailer brakes and/or un-chock the trailer.

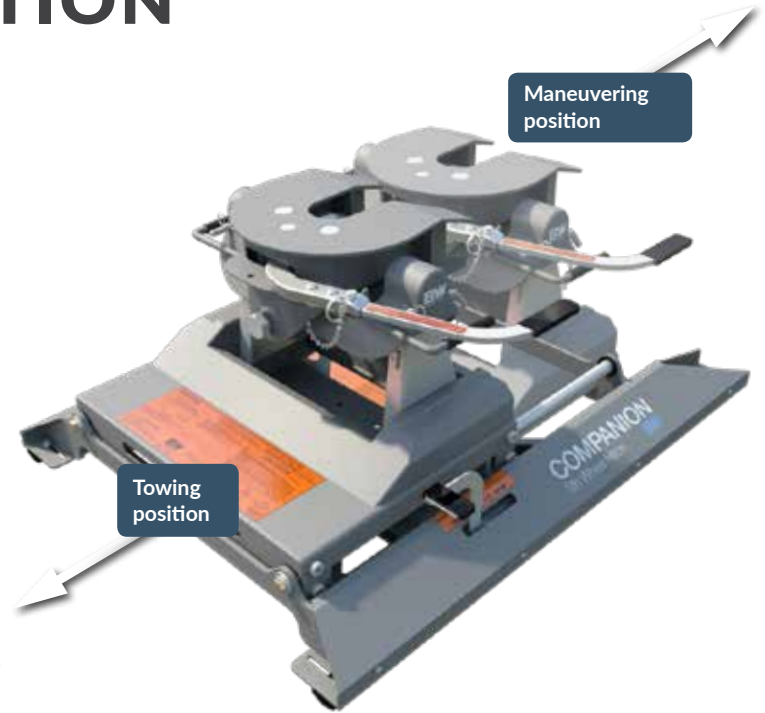

# DISCONNECTING YOUR TRAILER

1. Lower landing gear and chock the trailer wheels.

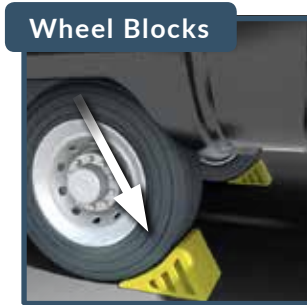

2. Raise the trailer until the tongue weight is removed from the truck.

3. Unpin the coupler handle and rotate to the open position to release the jaws.



4. Use the safety pin to lock the handle in the open position and when you are sure that the landing gear will support the trailer, move the truck forward to release the jaws from the kingpin.
5. If the jaws do not open, that may be an indication that there is still downward pressure on the jaws. Readjusting the landing gear may relieve that pressure. However, if the handle is open, the jaws will always open as you pull away once pressure is relieved.



# HITCH MAINTENANCE

There are four places on the Companion that you should lubricate regularly.

1. Grease the saddle through the grease zerk approximately every six months with multi-purpose grease. This allows the coupler to pivot freely.

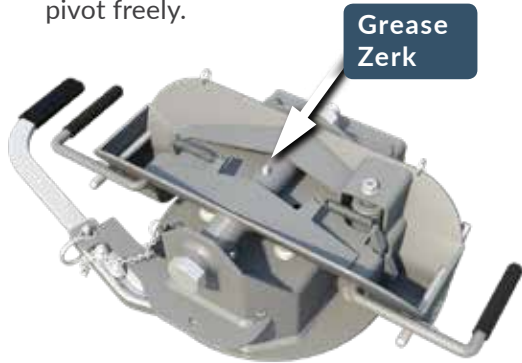

2. Spread a thin layer of multi-purpose grease around the inside surface of the jaws where they grasp the kingpin. You may also want to apply some grease to the kingpin on your trailer.

3. As needed, grease the polyurethane bushings with high-grade lithium grease.



Note: No lubrication of the sliding mechanism is necessary.



# BW<sup>®</sup>

## TRAILER HITCHES

### MULTI-PURPOSE WHITE LITHIUM GREASE

- Lubricates and Protects
- Water Resistant
- Single Use

**LOVE YOUR HITCH  
LONGER!**

Net Wt. 7 g

Here is your first grease packet to get you started. If you need more, feel free to contact us at 800-248-6564

4. Lubricate the top surface of the coupler with automotive type chassis grease or use a nylon lube plate to provide a lubricated surface.



## LUBE PLATES

Lube plates come in all sizes. We recommend a 10" version, like this one infused with graphite, available online at [bwtrailerhitches.com/product/graphite-lube-plate](http://bwtrailerhitches.com/product/graphite-lube-plate)

# LET'S TALK TESTING

WITH B&W ENGINEERING MANAGER, TAYLOR JONES

## **Q: WHAT TESTING STANDARDS EXIST TODAY FOR GOOSENECK AND FIFTH WHEEL HITCHES?**

**A:** SAE-J2638 is the standard that establishes the minimum performance criteria for gooseneck and fifth-wheel hitches up to 30,000 lbs. Currently, the standard is a recommended practice and NOT a requirement to sell or use a trailer hitch.

However, I strongly believe that anyone towing a gooseneck or fifth-wheel should be using equipment, whether it's ours or another brand, that has been tested and passes the J-2638 standards. I recommend customers ask before buying.

## **Q: WHAT DOES SAE-J2638 REQUIRE?**

**A:** The standard requires hitches to complete nine independent tests without loss of attachment. (This means that if the damage occurred while driving, it would not allow the trailer to separate from the truck.)

The nine tests include static tests of force against the hitch in six directions and three dynamic tests of 300,000 cycles each. And while the standard allows you to use a different specimen for each test, my personal requirement for B&W is that a single specimen pass the dynamic tests and *then also* pass the static tests. I think this reflects what happens in the real world. An accident rarely happens when a hitch is brand-new. It happens after years of wear from the road.



**STATIC:** Load is applied at an even rate to determine the structural integrity and absolute strength of the structure.

**DYNAMIC:** (Cyclical) a load is applied, released, then applied again to determine the overall structural integrity and its resistance to fatigue failure.

Static tests simulate extreme load situations, such as hard braking.

Dynamic tests simulate thousands of miles of extreme use.



**LONGITUDINAL**



**TRANSVERSE**



**VERTICAL**

## **Q: HOW DOES B&W USE THE TESTING DATA?**

**A:** Before we build a trailer hitch, we model it using CAD software. Then, in a digital environment, we subject it to the types of forces we know exist, using FEA (Finite Element Analysis.) This modeling gives us a good idea of what we will see on the testing equipment and in real situations. From there, a prototype is built and we run it through the full gamut of J-2638 tests at the max tow rating for the truck it is designed to fit.

After the J-2638 testing is complete, we also subject our designs to real world testing by using them to tow heavy trailers with different types of loads. We've been collecting data on how hitches perform for a long time. When we see hitches that have been in accidents, it confirms the data that we have. It's reassuring to see our hitches perform on the road the way we predicted in the lab.



# OUR APPROACH TO WARRANTY

It is our policy to stand behind the products we build.

We are confident that our products are made without design or quality defects. However, if you believe that one of our products doesn't live up to our standards, we would make it right with you, our customer.

If your product suffers damage because of an accident or misuse on your part, we would work with you to get you back on the road with as little cost and hassle to you as possible, because that is just being a good neighbor.

We can't keep your product in 'new' condition and your product and the finish will age through normal wear and tear. You should only use our products in the manner intended in their design. Most of our products require some routine maintenance to continue to work as they did when they were new.

We appreciate it when our customers register their products with us. However, we offer our warranty regardless.

To register your product with us,  
please go to [www.bwtrailerhitches.com/warranty](http://www.bwtrailerhitches.com/warranty)  
or call us at **800-248-6564**.



# OUR AMERICAN DREAM STORY

Like many, ours began in a garage in 1987, with two men and an idea. Roger Baker and Joe Works (the 'B' and the 'W') began building custom truck beds and quickly recognized a way to improve the inconvenience of a gooseneck ball permanently welded in the bed. They designed a gooseneck hitch with the mounting hardware underneath the bed and a ball that turned over and stowed where it was used. The Turnoverball<sup>®</sup> Gooseneck Hitch was born.

A few years later, they applied the same concepts to fifth-wheel hitches. Using the same under-bed mounting hardware and hole in the bed, they designed the Companion<sup>®</sup> with a single-point attachment that was removable when not towing. They also designed the Companion to be quiet and smooth when towing.

While competitors take manufacturing to China and Mexico, Joe (Roger retired in 1999) remains committed to using American-made raw materials and American Labor.

***"You don't work for me, you work for the customer. We can compete in this global economy by designing better, using technology, and truly caring about our customers," Joe affirmed.***

Our product line now includes all types of towing products manufactured under the 497,000 sqft. facility. In 2007, Joe began transferring ownership of the company to us, the now 425 employee-owners.





# LIKE THE QUALITY OF YOUR COMPANION?

CHECK OUT OUR OTHER PRODUCTS

Request our Product Catalog by calling 800-248-6564 or at [www.bwtrailerhitches.com](http://www.bwtrailerhitches.com)



**TOW & STOW®**



**B&W GEAR**  
BECAUSE YOU CAN'T  
WEAR A TRAILER HITCH



# WE'D LOVE TO HEAR FROM YOU!

B&W Trailer Hitches | 1216 Hawaii Road | Humboldt, KS 66748

**800.248.6564**

Live chat with us on our website  
[bwtrailerhitches.com](http://bwtrailerhitches.com)

