



BLUE OX[®]

BX1007 2001-03 Acura CL Installation Instructions

Baseplate Installation Instructions

Serial Number

Please read **BOTH** these Installation Instructions and the General Instructions before attempting to install or operate this equipment.

- Blue Ox[®] towing products and accessories are intended to be installed by Blue Ox[®]. Dealers who are familiar with our products and have the equipment necessary and knowledge to do "fit work". When necessary Blue Ox[®] Dealers can be found at www.blueox.us or by contacting our Customer Care Department at (402) 385-3051 or toll free (888) 425-5382.
- Many Blue Ox[®] Baseplates are designed to use existing holes and hardware to mount the baseplate to the towed vehicle. Even though bolts are there, do not assume they are adequate for baseplate mounting. Always use hardware supplied in the hardware kit and existing hardware specified in the Baseplate Installation Instructions.

Attachment Tab Height: 12"

Attachment Tab Width: 24"

Bolt Torque Specifications

Torque in Foot-Pounds per Metric Bolts

Bolt Size	Grade 8.8	Grade 10.9
6MM	6	8
8MM	16	22
10MM	31	40
12MM	54	70
14MM	89	117

Confirm the towability and pre-towing procedures for your vehicle with the owner's manual or contact the vehicle's manufacturer for specific towing procedures. You can also contact REMCO for additional information at 1(800)228-2481.

Bolt Torque Specifications

Torque in Foot-Pounds per Inch Bolts

Bolt Size	Grade 5	Grade 8
1/4"	10	14
5/16"	19	29
3/8"	33	47
7/16"	54	78
1/2"	78	119
5/8"	154	230



! WARNING

Failure to read and follow these instructions could result in separation of the towed vehicle from the tow bar, causing property damage, loss of towed vehicle, personal injury or death.

BX1007

2001-03 Acura CL

Installation Instructions

Parts List

Ref. No.	Qty.	Part #	Description
1	1	61-5522	Weldment, Baseplate, BX1007
2	3	61-4978	3/8" Whiz Nut, w/ 14" Wire
3	2	61-5331	Weldment, Bolt Plate, 3/8-16 x 1 1/4"
4	7	201-0368	3/8-16 x 1 1/4" Hex Bolt, Grd. 5, ZP
5	7	203-0010	3/8" Lock Washer, ZP
6	6	202-0003	3/8-16 Hex Nut, ZP
7	3	203-0003	3/8" Flat Washer, ZP
8	2	201-0979	#12-14 x 1" Self Drilling Screw, ZP
9	2	201-0192	#10-32 x 1/2" Slot RD. HD. Screw
10	2	101-5822	Adapter, 4 Way Connector
11	2	203-0054	#10 Lock Washer
12	2	202-0047	#10 Hex Nut

Tools Required

12MM Wrench	C Clamp
14MM Wrench	Utility Knife
9/16" Wrench	Phillips Screwdriver
3/4" Wrench	LOCTITE Red

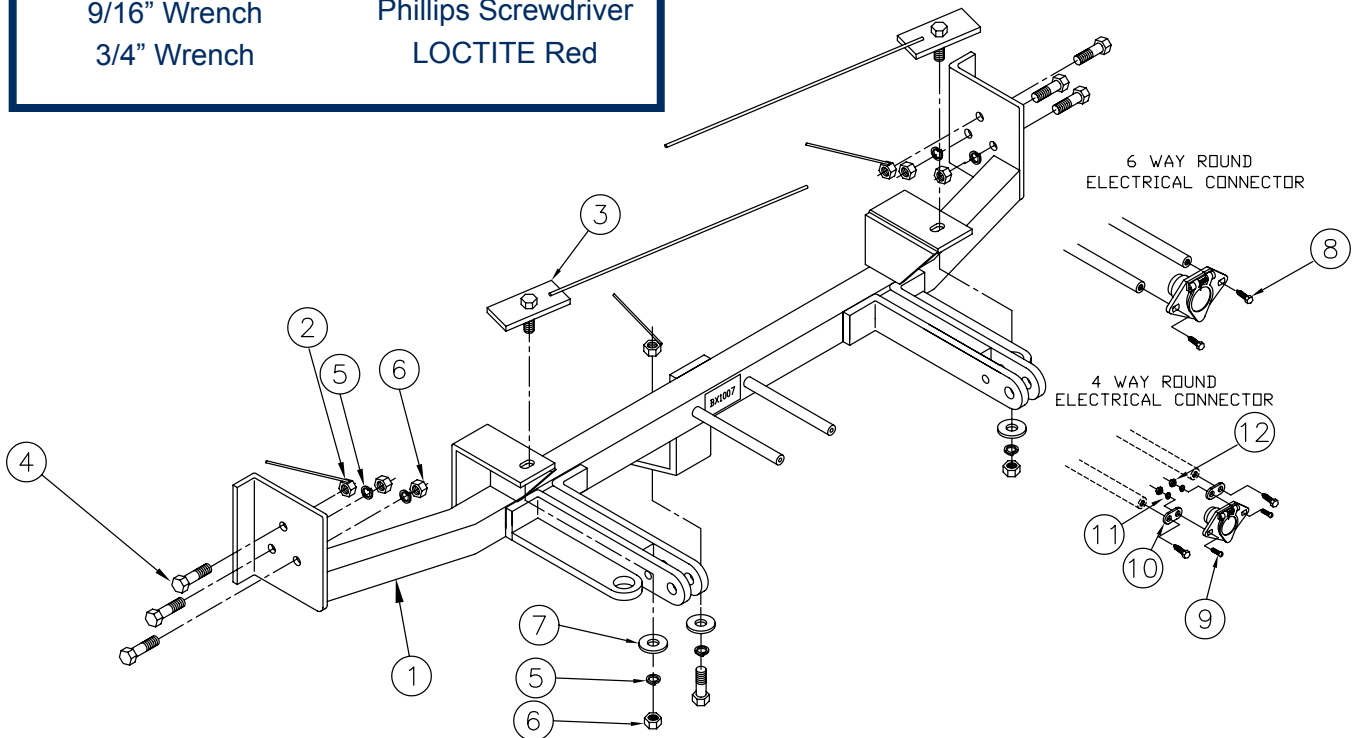

Important:

Use only genuine factory replacement parts on your baseplate. Do NOT substitute homemade or non-typical parts. If a bolt is lost or in need of replacement, for your safety and the preservation of your baseplate, be sure to use a replacement bolt of the same grade (In most cases it will be Grade 5, please reference the parts list above). Replacement parts may be ordered through your nearest Blue Ox® Dealer or Distributor, or call our 24/7 Customer Care Team at (402)385-3051.

BX1007
2001-03 Acura CL
Installation Instructions

Standard Tab Spacing Guidelines:

Due to the design of the removable tabs, the RangeFinderII tow bar can not be used. Adapters, except the BX8833 and BX88151, can not be used with this baseplate.

Instructions:

The front fascia is removed and replaced for baseplate installation. Drilling is required.

The dimensional variations between otherwise identical vehicles can be considerable. While the baseplate was designed for easy installation, it may be necessary to tailor the baseplate slightly to compensate for auto manufacturer's tolerances. These minor adjustments may include filing a hole slightly, bending electrical rods, and/ or bending end plates.

The BX8869 Bulb and Socket Wiring Kit is recommended for this vehicle.

Installation Instructions



1. Open hood and remove pushpins from the top of the grille and set aside to be reinstalled later.

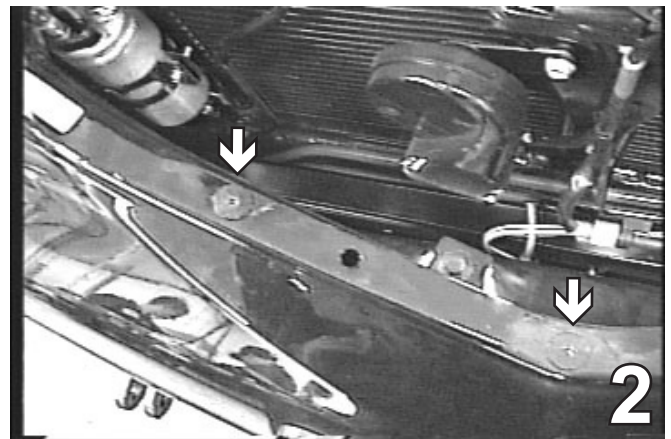

2. Remove the Phillips screws from the top of the plastic fascia. Set screws aside to be reinstalled later.

BX1007
2001-03 Acura CL
Installation Instructions



3. Remove the bolt from the wheel well molding forward of the front tires and the pushpins and bolts from the bottom of the fascia. Remove the fascia from the vehicle. Do this to both sides of the vehicle.

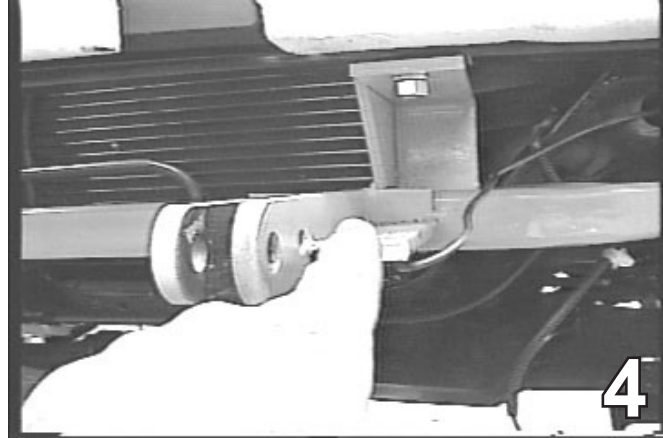

4. Hold the baseplate up so it straddles the frame and the front braces lay flush to the bottom of the metal bumper and the center brace lines up to an existing hole in the lower cross member.

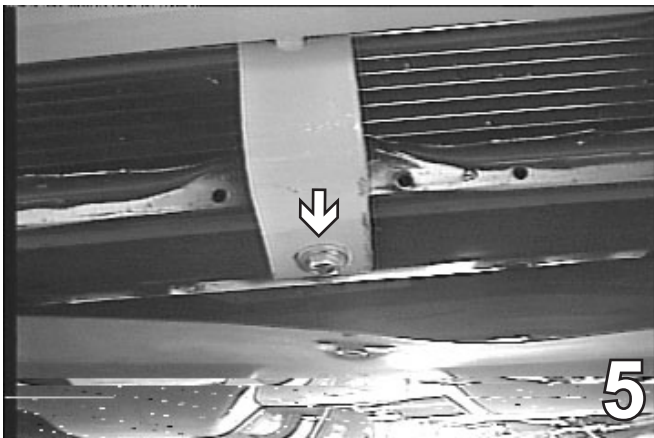

5. Use the 3/8" -16 x 1 1/4" hex bolts and 3/8" whiz nut with 14" wire for the lower brace, tighten the nut and the bolt. **Use LOCTITE red with each bolt throughout the installation.**

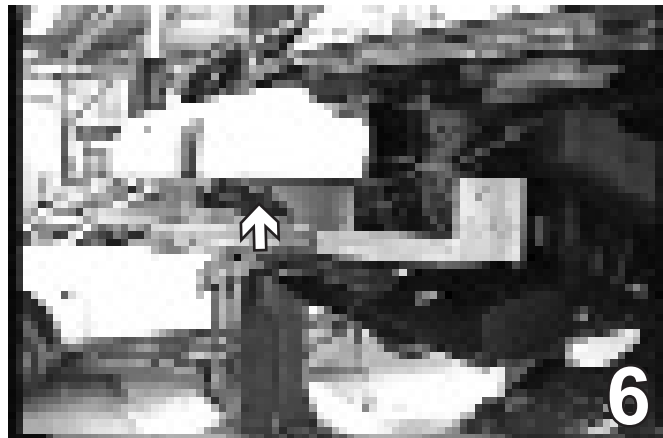

6. Clamp the baseplate so the two braces are flush with the bottom of the metal bumper. Drill 3/8" holes and use the 3/8"-16 x 1 1/4" hex bolt, 3/8" lock washer, 3/8-16 hex nut, and the 3/8" flat washer.

BX1007
2001-03 Acura CL
Installation Instructions



7. Insert the nut plates through the side of the bumper for the front braces.

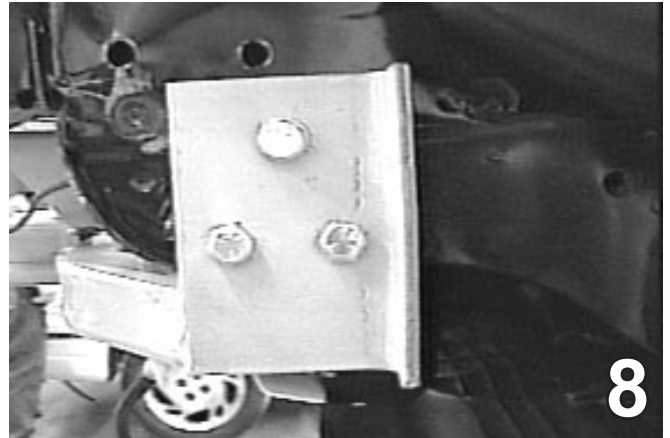

8. Once the middle braces are bolted to the frame, drill the 3/8" holes for each side. Use the 3/8"-16 x 1 1/4" hex bolt, 3/8" lock washer, and 3/8 flat washer.

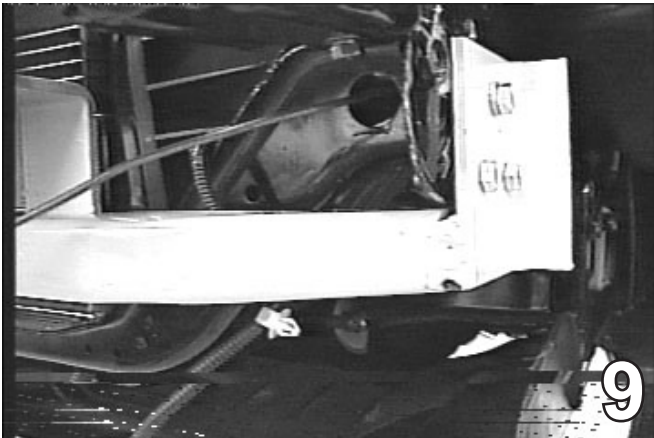

9. Insert the wire nut plate through the large hole on the cross frame. Tighten bolts according to the chart on the front page of this document.

10. Replace the electrical connections, bumper and fascia. Baseplate installation is now complete.

Install the tow bar and safety cables according to the instructions included in their packages.

Do not substitute other devices if the tow bar pin and clip are lost.

DEALER OR INSTALLER: BE CERTAIN THE USER RECEIVES THE INSTRUCTION SHEETS.

BX1007
2001-03 Acura CL
Installation Instructions

CUSTOMER SERVICE COMMITMENT

Blue Ox is committed to providing you with exceptional customer care throughout your lifetime with our products. Our team is here to assist you with any questions you may have regarding the performance of your product. Simply call 1-800-228-9289 and you can speak with our customer care team.

Additionally, please visit our website to see which rallies our Destination America team will be attending. For a nominal fee, our service technician will service your towing system to ensure it's in proper working condition. Also as a commitment to our customers, should you visit our factory you can stay at our full service Blue Ox campground at no charge along with enjoying a factory tour.

Again thank you for being our customer and for the confidence you have shown in the performance of our products. It is because of customers like you we enjoy the success we have today.



© 2005 Blue Ox
One Mill Road, Industrial Park
Pender, Nebraska 68047
Phone: (402) 385-3051
Toll Free: (888) 425-5382
Fax: (402) 385-3360
www.blueox.us