



BLUE OX® 2004-06 Acura MDX

Baseplate Installation Instructions

Installation Instructions

BX1015

Serial Number

Please read BOTH these Installation Instructions and the General Instructions before attempting to install or operate this equipment.

- Blue Ox® towing products and accessories are intended to be installed by Blue Ox® Dealers who are familiar with our products and have the equipment necessary and knowledge to do "fit work". When necessary Blue Ox® Dealers can be found at www.blueox.us or by contacting our Customer Care Department at (402) 385-3051 or toll free (888) 425-5382.
- Many Blue Ox® Baseplates are designed to use existing holes and hardware to mount the baseplate to the towed vehicle. Even though bolts are there, do not assume they are adequate for baseplate mounting. Always use hardware supplied in the hardware kit and existing hardware specified in the Baseplate Installation Instructions.

Attachment Tab Height: 26 1/4"

Attachment Tab Width: 25"

Bolt Torque Specifications

Torque in Foot-Pounds per Metric Bolts

Bolt Size	Grade 8.8	Grade 10.9
6MM	6	8
8MM	16	22
10MM	31	40
12MM	54	70
14MM	89	117

Confirm the towability and pre-towing procedures for your vehicle with the owner's manual or contact the vehicle's manufacturer for specific towing procedures.

Bolt Torque Specifications

Torque in Foot-Pounds per Inch Bolts

Bolt Size	Grade 5	Grade 8
1/4"	10	14
5/16"	19	29
3/8"	33	47
7/16"	54	78
1/2"	78	119
5/8"	154	230



! WARNING

Failure to read and follow these instructions could result in separation of the towed vehicle from the tow bar, causing property damage, loss of towed vehicle, personal injury or death.

BX1015

2004-06 Acura MDX

Installation Instructions

Parts List

Ref. No.	Qty.	Part #	Description
1	1	61-6212	Weldment, Baseplate, BX1015
2	4	61-5589	Nut plate, 3/8-16 Nut, w/ 14" Wire
3	4	61-5208	3/8-16 Nut plate, 1/4 "x 1" x 1", w/14" Wire
4	2	102-6682	Backing Plate, BX1015
5	12	201-0440	3/8-16 x 1 1/2" Hex Bolt, Grd. 5, ZP
6	12	203-0010	3/8" Lock Washer, ZP
7	4	203-0003	3/8" Flat Washer, ZP
8	4	202-0003	3/8-16 Hex Nut, ZP
9	4	201-0446	8MM-1.25 x 30MM Hex Bolt, Grd. 8.8, ZP
10	4	203-0009	5/16" Lock Washer, ZP
11	4	203-0002	5/16" Flat Washer, ZP
12	2	201-0979	#12-14 x 1" Self Drilling Screw, ZP
13	2	201-0192	#10-32 x 1/2" Slot, Rd. Hd. Screw
14	2	203-0054	#10 Lock Washer
15	2	202-0047	#10-32 Hex Nut
16	2	101-5822	Adapter, 4 Way Connector
17	2	62-3468	Attachment, Assembly, SF/SB (R)
	2	226-0046	Baseplate Safety Cable, 36" CL III (Not Shown)
	2	229-0359	Quicklink, 3/8, ZP (Not Shown)
	2	290-0437	Cap Plug, Black (Not Shown)

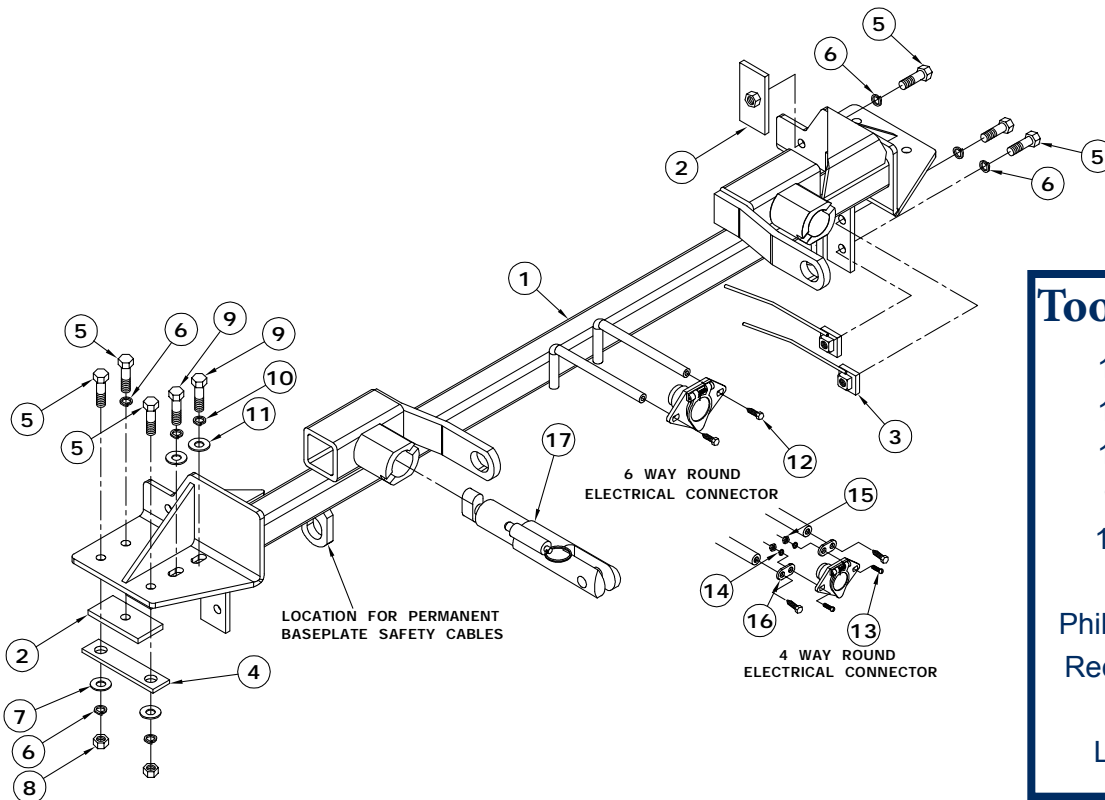

Tools Required

- 12MM Socket
- 14MM Socket
- 13MM Socket
- 9/16" Socket
- 13/32" Drill Bit
- Utility Knife
- Phillips Screwdriver
- Reciprocating Saw
- Vise Grip
- LOCTITE Red

Important:

Use only genuine factory replacement parts on your baseplate. Do NOT substitute homemade or non-typical parts. If a bolt is lost or in need of replacement, for your safety and the preservation of your baseplate, be sure to use a replacement bolt of the same grade (In most cases it will be Grade 5, please reference the parts list above). Replacement parts may be ordered through your nearest Blue Ox® Dealer or Distributor, or call our 24/7 Customer Care Team at (402)385-3051.

BX1015

2004-06 Acura MDX

Installation Instructions

Attachment Tabs:

Due to the design of the removable tabs, the RangeFinder II and Ambassador tow bars can not be used. Adapters, except the BX8833 and the BX88151, can not be used with this baseplate.

Instructions:

The front fascia, headlights, horn bracket, and air baffle are removed for the baseplate installation. Drilling is required. Trimming of the air dam and the grille is required.

The dimensional variations between otherwise identical vehicles can be considerable. While the baseplate was designed for easy installation, it may be necessary to tailor the baseplate slightly to compensate for auto manufacturer's tolerances. These minor adjustments may include filing a hole slightly, bending electrical rods, and/ or bending end plates.

The BX8869 Bulb and Socket Wiring Kit is recommended for this vehicle.



1. Remove 11 pushpins from the plastic above the radiator. Remove the plastic from the top of the radiator. Set pushpins aside to reinstall later.

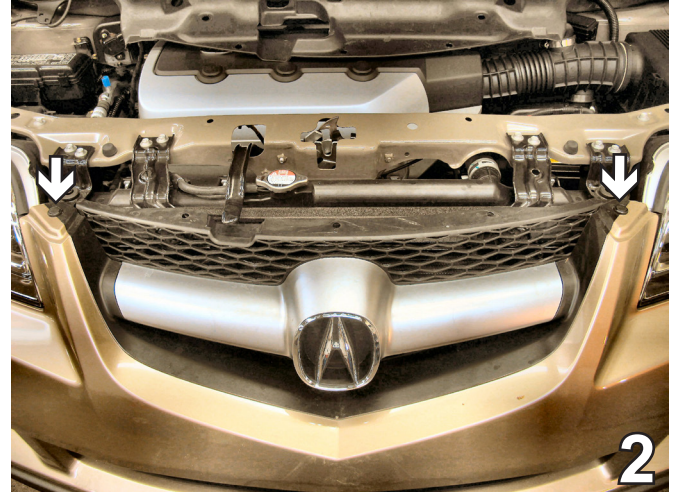

2. Between the headlight and the grille, on the top side of the fascia, remove two pushpins. Set pushpins aside.

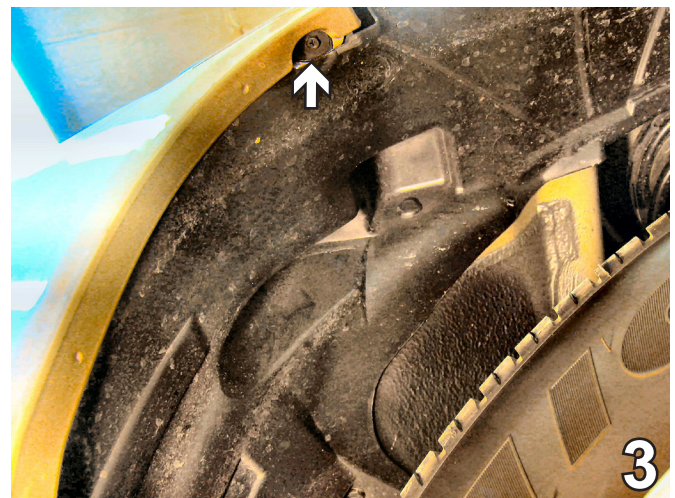

3. Just forward of the front tire, on the edge of the fascia, use an 8MM socket or Phillips screwdriver to remove one metric bolt. Set bolt aside to reinstall later. Do this to both sides of the vehicle.

BX1015

2004-06 Acura MDX

Installation Instructions

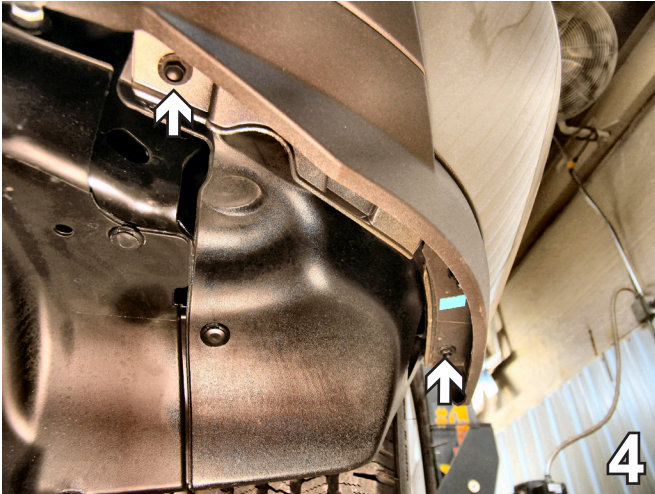

4. Just forward of the front tire, on the outermost bottom edge of fascia, remove two metric bolts using a 10MM socket, as indicated by the white arrow in the photo above. Do this to both sides of the vehicle. Set bolts aside to reinstall later.

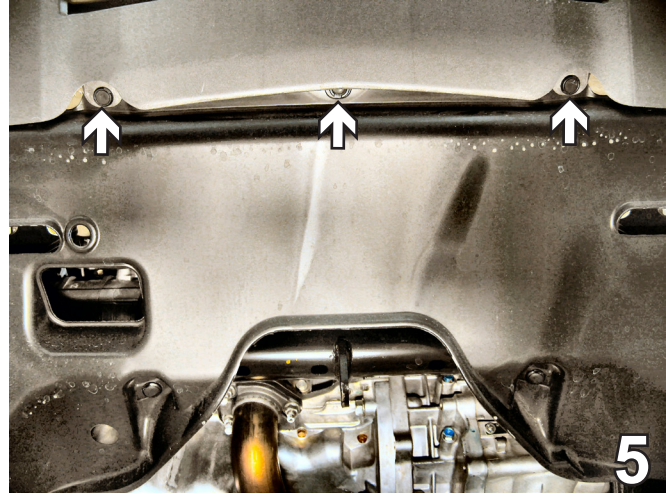

5. Remove three pushpins that run horizontally along the bottom of fascia, where the belly pan and fascia meet. Set bolts aside to be reinstalled later.

6. Start fascia removal by pulling down on the fascia where it meets the fender, just forward of the front tire. While still on the side of the vehicle, pull fascia slightly forward – releasing it from two clips. Do the steps above to both sides of the vehicle. From the front of the vehicle, pull fascia forward enough to disconnect the fog lights. Then, continue pulling fascia forward to remove. Carefully set fascia aside to reinstall later.

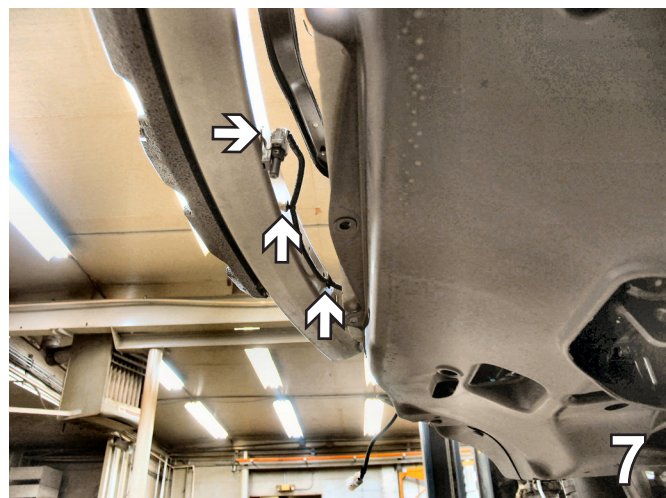

7. Behind the bumper, remove the temperature sensor from its clip. Also remove two pushpin connectors for the coax cable that are secured behind the bumper. Set temperature sensor and coax cable out of the way to be reinstalled later.

BX1015

2004-06 Acura MDX

Installation Instructions

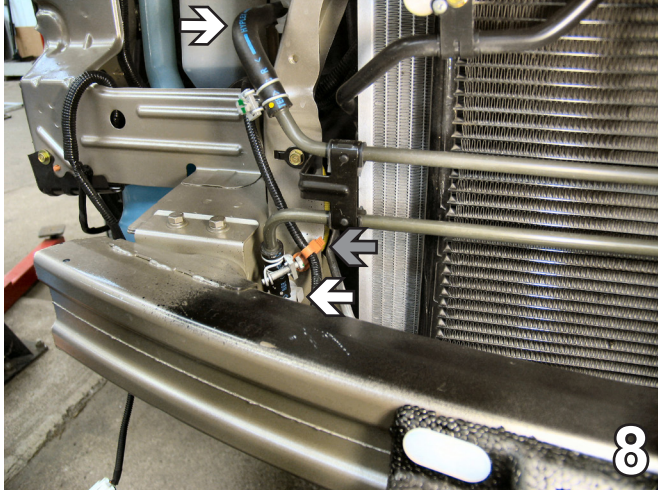

8. On the passenger's side remove one coax cable pushpin connector from the radiator support – just below the coolant tubing (see grey arrow). Release the clips from the coolant hose (see white arrows). Find one immediately behind the bumper, next to the frame rail. The other is found midway up the radiator support.

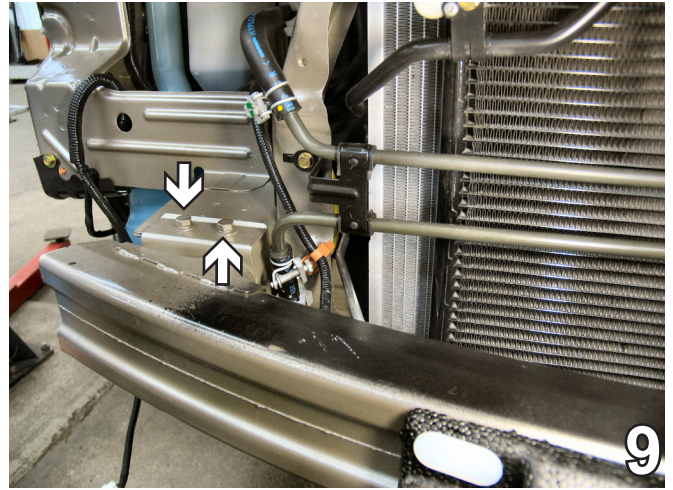

9. Using a 12MM socket, remove two metric bolts from the metal bumper bracket and one metric bolt underneath the metal bumper. Do this to both sides of the vehicle. Pull bumper forward to remove. Set metal bumper and bolts aside to reinstall later.



10. Lay the bracket of the metal bumper on a solid surface. Use a hammer to pound and flatten the rib on top of the bracket. Do this to both sides of the vehicle.



11. Mark and cut a section of the bumper bracket edge that faces toward the center of the bumper. Using the reciprocating saw, make a horizontal cut on the top of the bracket removing 3/8" from the end of the bracket. The cut travels the length of the top of bracket and down over the bracket lip about 1/4".

BX1015

2004-06 Acura MDX

Installation Instructions

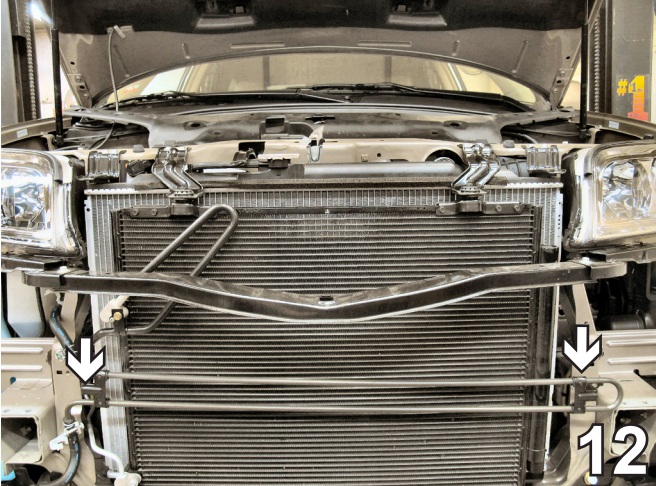

12. On the lower section of the radiator support, use a 10MM socket to remove the metric bolt of the coolant tubing bracket. Do this to both sides of the vehicle. Swivel the coolant line out of the way to clear the area for baseplate installation.

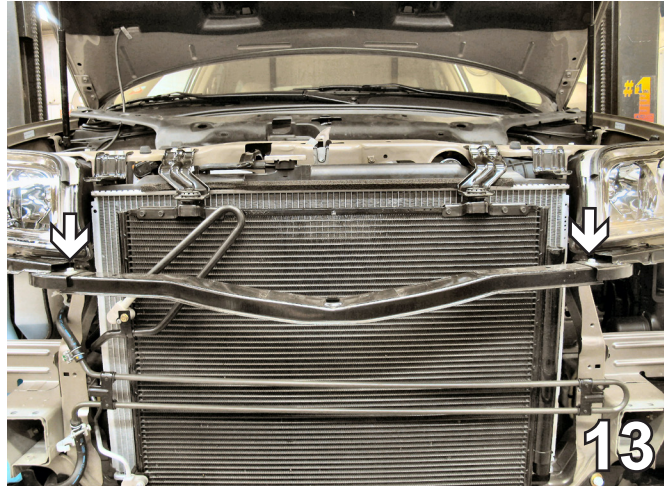

13. Using a 10MM socket, remove a metric bolt from either end of the headlight assemblies bracket. Set the bracket aside to be reinstalled later.

BE SURE TO USE LOCTITE® RED ON ALL BOLTS BEFORE TIGHTENING. TIGHTEN ALL BOLTS ACCORDING TO THE TORQUE CHART ON THE FRONT PAGE OF THESE INSTRUCTIONS OR ON PAGE 3 OF THE BASEPLATE TOWING GENERAL INSTRUCTIONS.

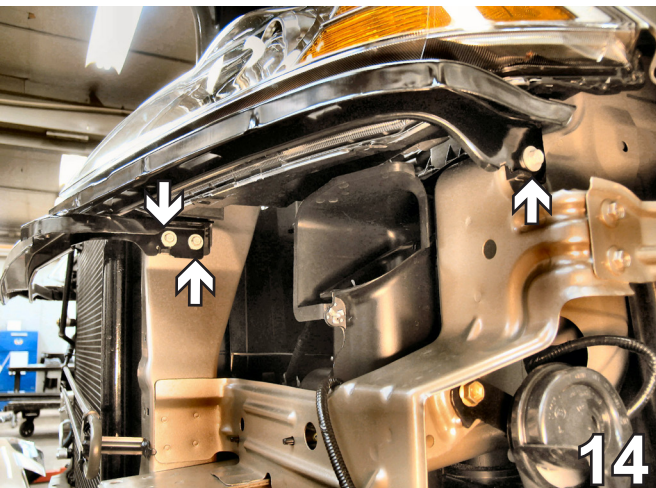

14. Using a 10MM socket, remove three metric bolts from the lower portion of the headlight assemblies bracket. One is located under the headlight, on the outermost edge of bracket. Two are located closer to the mid point of bracket that is secured to the radiator support. Do this to both sides of the vehicle.



15. Using a 10MM socket. Pull the headlight assemblies forward to remove. Disconnect electrical connections. Set bolts and headlight assemblies aside to reinstall later.

BX1015

2004-06 Acura MDX

Installation Instructions

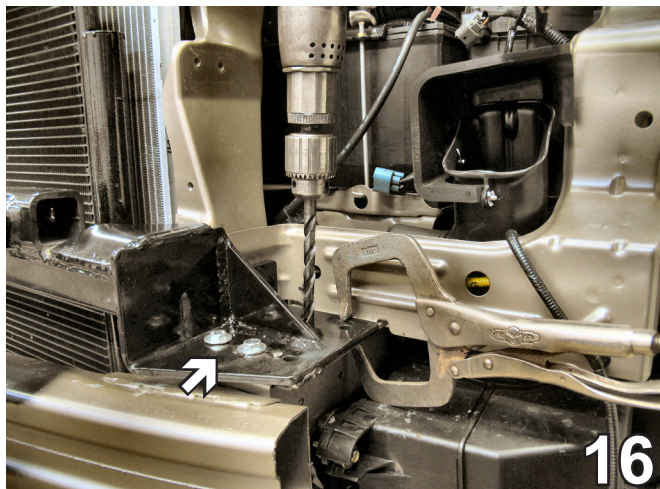

16. Slide metal bumper back on to the frame rail, guiding the baseplate on top of frame rail. Align with the existing holes of the bumper bracket. Insert two 8MM-1.25 x 30MM hex bolts through the baseplate into the two existing bumper bracket holes using 5/16" lock washer and 5/16" flat washers (see arrow). Using a vice grip; clamp the rear of the baseplate. Using the baseplate as a template, drill into the frame rail through the remaining baseplate holes (six). Three are found on the top of the baseplate, another on the side resting against the radiator support. Two more are on the lower portion of the baseplate resting against the side of frame rail. Do this to both sides of the vehicle.

17. Using the 13MM socket, remove the two metric bolts on the top of the baseplate. Do this to both sides of the vehicle. Set the bolts, baseplate and metal bumper aside. Swivel the coolant line back to its original position and reinstall existing metric. Set the baseplate on the top of the frame to align with drilled holes.
18. Guide a 3/8-16 nut plate through the frame opening and align with bolt hole toward the rear of the baseplate, nearest the radiator support. Insert the 3/8-16 hex bolt into those bolt hole with the 3/8 lock washer and hand tighten. Do this on both sides of the vehicle.
- Be sure to use LOCTITE Red on ALL bolts.**

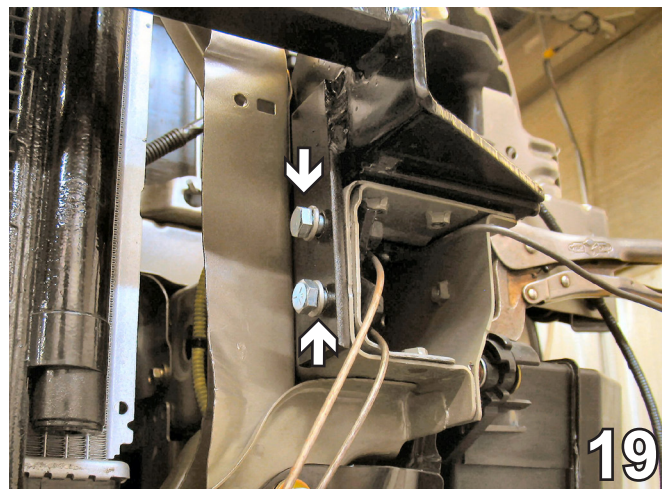

19. Insert the 3/8-16 hex bolts with the 3/8" lock washer through the baseplate holes on the side of the frame rail. Hand tighten bolts to the 3/8-16 nut plates placed on hex bolts through opening in frame end. Do this to both sides of the vehicle. Using diagonal cutters, cut all nut plate wires flush with the end of the frame. **Be sure to apply LOCTITE Red to ALL bolts.**

BX1015

2004-06 Acura MDX

Installation Instructions

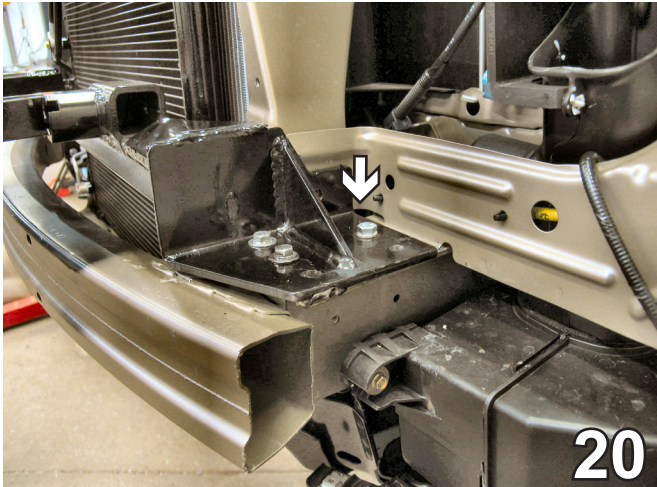

20. Slide bumper between frame and baseplate to align with existing mount locations. Insert two 8MM-1.25 x 30MM hex bolts with 5/16" lock washers and 5/16" flat washers and tighten. Tighten the bolt near the back of the baseplate, as indicated by the white arrow in the photo above. Do this to both sides of the vehicle.

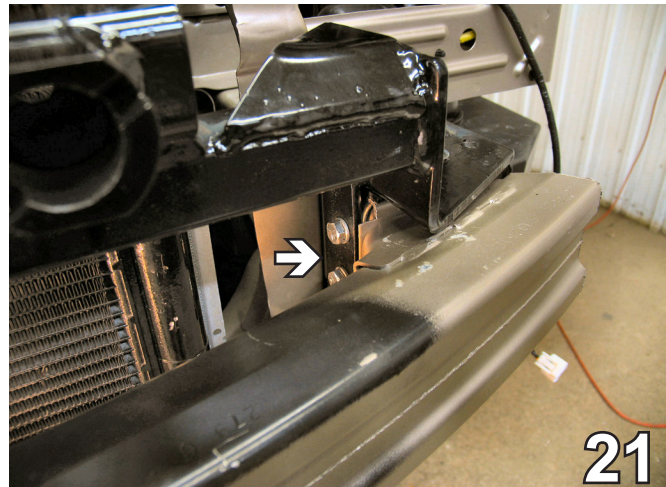

21. Tighten the bolts on the lower portion of the baseplate and all installed bolts in the top of the frame. Do this to both sides of the vehicle.

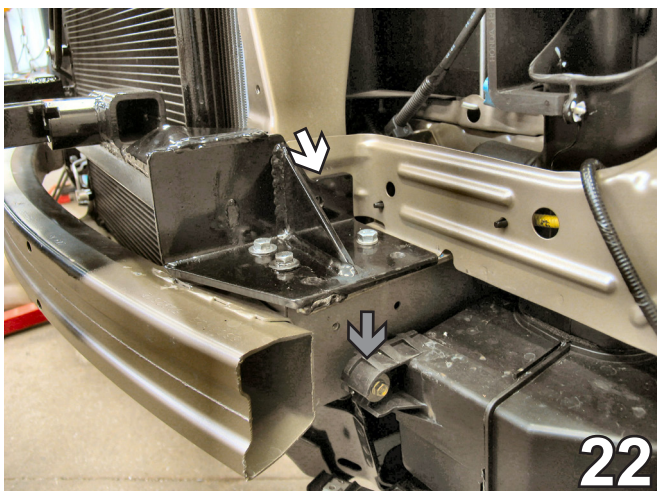

22. Align the nut plate with the drilled hole on the back side of the radiator support and tighten the 3/8-16 hex bolt and lock washer, as indicated by the white arrow in the photo. Do this to both sides of the vehicle. Using the 10MM socket, remove the metric bolt from the air baffle, as indicated by the grey arrow in the photo, and pull the air baffle down away from the frame.

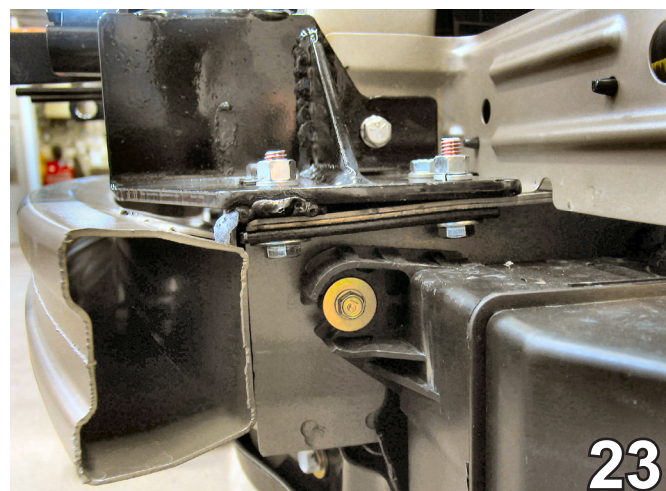

23. Place the backing plate on the bottom side of the frame webbing to align with drilled holes, insert the 3/8-16 x 1 1/2" hex bolts and 3/8" flat washers into this hole, tighten the 3/8-16 hex nuts and 3/8" lock washers. Reinstall the air baffle to its original position.

BX1015
2004-06 Acura MDX
Installation Instructions



24. Place the backing plate on the bottom side of the frame webbing to align with drilled holes, insert the 3/8-16 x 1 1/2" hex bolts and 3/8" flat washer into this hole, tighten the 3/8-16 hex nut and 3/8" lock washers.

Reinstall temperature sensor, hose clamps, headlight assemblies, and fascia. Be sure to install all pushpins and bolts.

Baseplate Installation is now Complete.

Install the tow bar and safety cables according to their instructions. When demonstrating this to the customer, be sure to include all of the Blue Ox packaging and contents.

Be sure that ALL electrical connections are plugged in properly and functioning BEFORE installing the fascia.

DEALER OR INSTALLER:

Be certain the user receives the instruction sheets for their products.

BX1015

2004-06 Acura MDX

Installation Instructions



CUSTOMER SERVICE COMMITMENT

Blue Ox is committed to providing you with exceptional customer care throughout your lifetime with our products. Our team is here to assist you with any questions you may have regarding the performance of your product. Simply call 1-800-228-9289 and you can speak with our customer care team.



Additionally, please visit our website to see which rallies our Destination America team will be attending. For a nominal fee, our service technician will service your towing system to ensure it's in proper working condition. Also as a commitment to our customers, should you visit our factory you can stay at our full service Blue Ox campground at no charge along with enjoying a factory tour.

Again thank you for being our customer and for the confidence you have shown in the performance of our products. It is because of customers like you we enjoy the success we have today.



© 2007, 08, 09 Blue Ox
One Mill Road, Industrial Park
Pender, Nebraska 68047
Phone: (402) 385-3051
Toll Free: (888) 425-5382
Fax: (402) 385-3360
www.blueox.us
7/23/09