



BX1119

2002-04 Jeep Liberty Installation Instructions

Serial Number

Please read **BOTH** these Installation Instructions and the General Towing Instructions before attempting to install or operate this equipment.

- Blue Ox® towing products and accessories are intended to be installed by Blue Ox® Dealers who are familiar with our products and have the equipment and knowledge to do “fit work”. When necessary Blue Ox® Dealers can be found at www.blueox.com or by contacting our Customer Care Department at (402) 385-3051 or Toll Free at (888) 425-5382.
- Many Blue Ox® Baseplates are designed to use existing holes and hardware to mount the baseplate to the towed vehicle. Even though bolts are there, do not assume they are adequate for baseplate mounting. Always use hardware supplied in the hardware kit or existing hardware specified in the Baseplate Towing Installation Instructions.

Attachment Tab Height: 19”

Attachment Tab Width: 20”

Bolt Torque Specifications		
Torque in Foot-Pounds for Metric Bolts		
Bolt Size	Grade 8.8	Grade 10.9
6MM	6	8
8MM	16	22
10MM	31	40
12MM	54	70
14MM	89	117

Confirm the towability and pre-towing procedures for your vehicle with the owner’s manual or contact the vehicle’s manufacturer for specific towing procedures.

Bolt Torque Specifications		
Torque in Foot-Pounds for Inch Bolts		
Bolt Size	Grade 5	Grade 8
1/4”	10	14
5/16”	19	29
3/8”	33	47
7/16”	54	78
1/2”	78	119
5/8”	154	230



WARNING

Failure to read and follow these instructions could result in separation of the towed vehicle from the tow bar, causing property damage, loss of towed vehicle, personal injury or death.

BX1119
2002-04 Jeep Liberty
Installation Instructions

Parts List

Ref. No.	Qty.	Part #	Description
1	1	61-5649	Weldment, Baseplate, BX1119
2	2	62-3468	Removable Attachment Tab (SF/SB)
3	4	61-5208	Weldment, 3/8-16, Nut Plate, With Wire
4	2	102-5597	Side Plate Support
5	4	201-0444	3/8-16 x 2" Hex Bolt, Grd. 5, ZP
6	4	203-0010	3/8" Lock Washer, ZP
7	4	203-0003	3/8" Flat Washer, ZP
8	2	201-0979	#12-14 x 1" Self Drilling Screw, ZP
9	2	202-0047	#10-32 Hex Nut
10	2	203-0054	#10 Lock Washer
11	2	201-0192	#10-32 x 1/2" Slot, Rd. Hd. Screw
12	2	101-5822	Adapter, 4 Way Connector
	2	226-0046	Baseplate Safety Cable, 36" CL III (Not Shown)
	4	229-0359	Quicklink 3/8, ZP (Not Shown)
	10	229-0536	6.3, Plastic Rivets (Not Shown)
	2	290-0437	Cap Plug, Black (Not Shown)

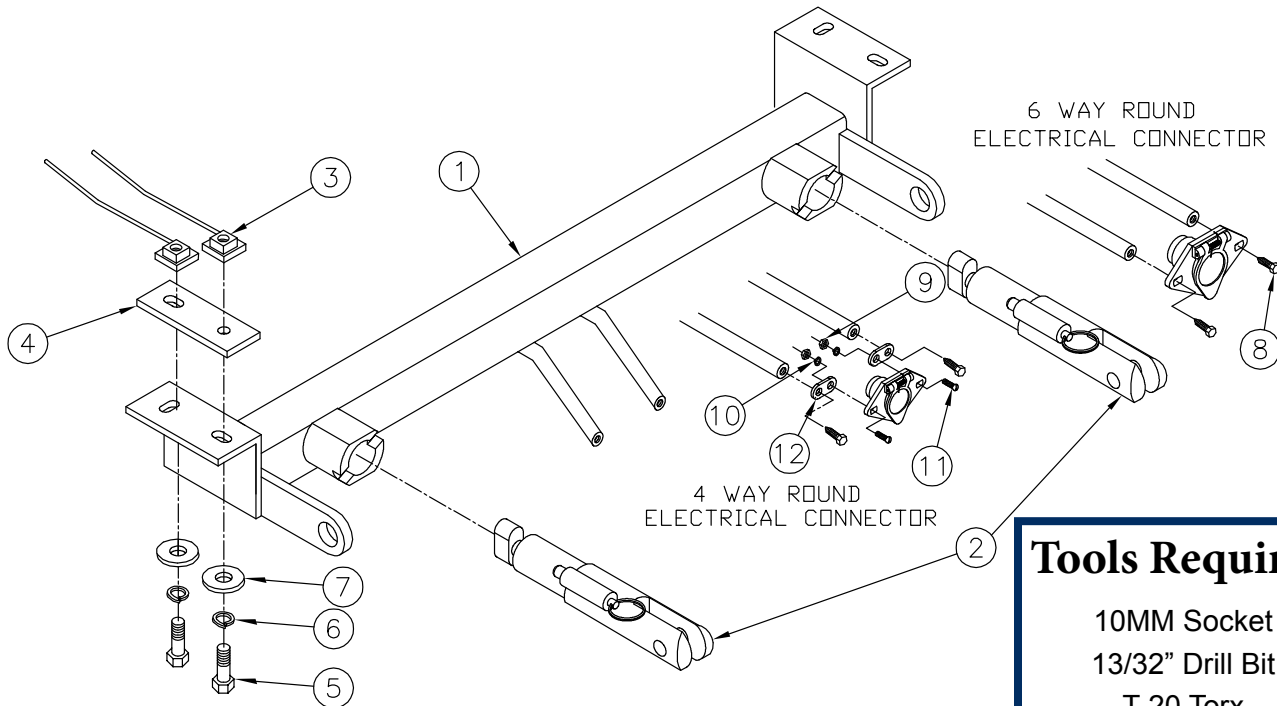

Tools Required

10MM Socket
13/32" Drill Bit
T-20 Torx
Phillips Screwdriver
Vise Grips
Side Cutters
Plastic Rivet Gun
Loctite® RED

Important:

Use only genuine factory replacement parts on your baseplate. Do **NOT** substitute homemade or non-typical parts. If a bolt is lost or in need of replacement, for your safety and the preservation of your baseplate, be sure to use a replacement bolt of the same grade (In most cases it will be Grade 5, please reference the parts list above). Replacement parts may be ordered through your nearest Blue Ox® Dealer or Distributor.

BX1119
2002-04 Jeep Liberty
Installation Instructions

Removable Tabs:

Motorhome mount tow bars are recommended for use with this baseplate. Due to the design of the removable tabs, the RangeFinder II, Adventurer and Ambassador tow bars can not be used. The Acclaim tow bar may be used, but will not fold and store on the front of the vehicle. Adapters, except for the BX8833 and the BX88151, can not be used with this baseplate.

Instructions:

The grille and front fascia are removed and reinstalled during the baseplate installation. Existing holes may need to be drilled out. There is **NO** trimming to the fascia. Tow hooks are removed and **NOT** reinstalled. Drilling is required.

The dimensional variations between otherwise identical vehicles can be considerable. While the baseplate was designed for easy installation, it may be necessary to tailor the baseplate slightly to compensate for auto manufacturer's tolerances. These minor adjustments may include filing a hole slightly, bending electrical rods, and/ or bending end plates.

The BX8869 Bulb and Socket Wiring Kit is recommended for this vehicle.



Installation Instructions:



1. Using the T-20 Torx, remove the two Torx bolts from the top of the headlight assembly and two on the top center of grille. Do this to both sides of the vehicle. Set the torx bolts aside to be reinstalled later. Pull top of grille forward and lift up to remove.

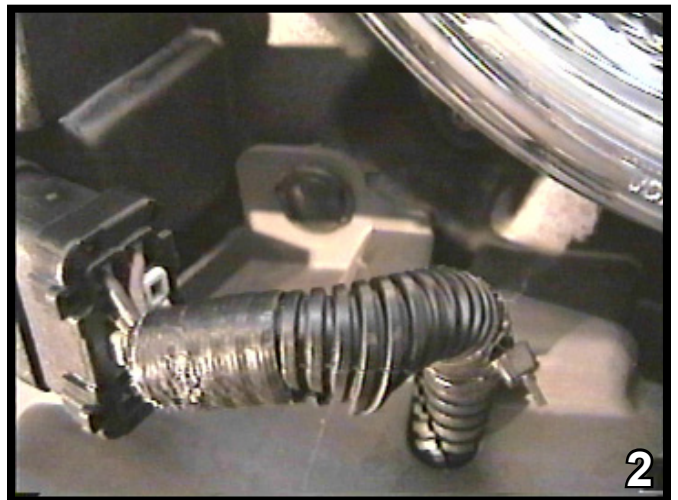

2. Remove the six push pins from the top side of the fascia. Disconnect the electrical plug on the driver's side as seen in the photo above.

BX1119
2002-04 Jeep Liberty
Installation Instructions

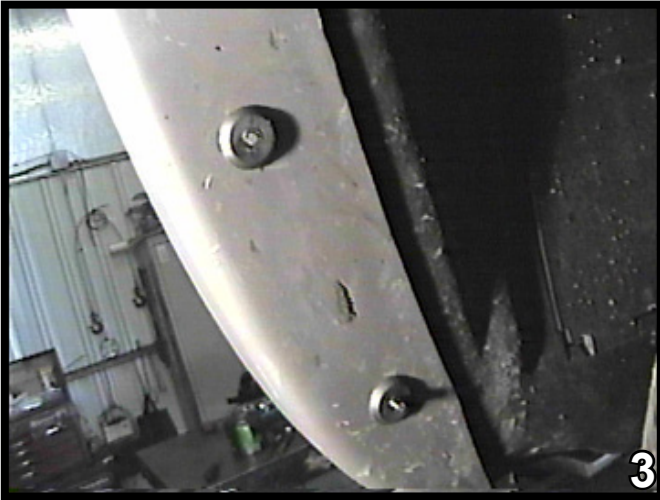

3. Just forward of the front tire are four rivets, cut and remove the three lower rivets and two rivets on the underside of the fascia corner. Do this to both sides of the vehicle. These rivets will be replaced by others later.

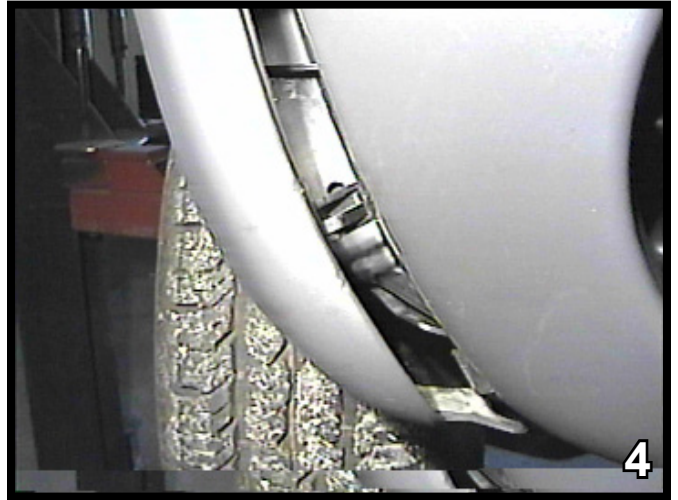

4. Release three clips from the fascia's side by opening the access panel on the wheel well, just forward of the front tires. Do this to both sides of the vehicle.

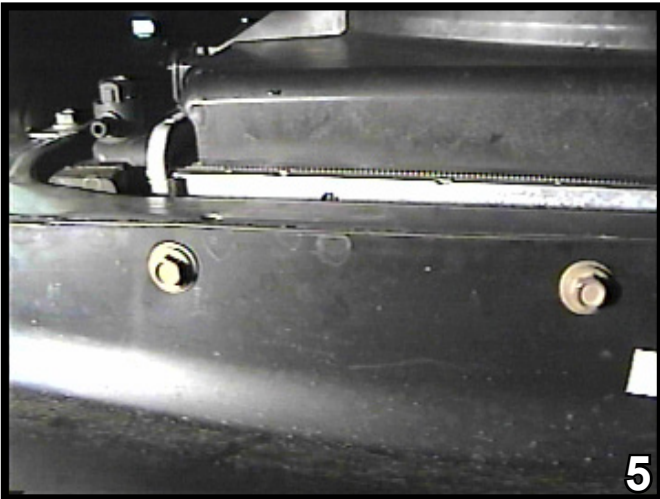

5. Using the 10MM socket, remove four metric bolts from the air dam under the radiator cross member. Set the bolts aside to be reinstalled later. Pull the fascia forward from the bottom and set aside carefully to be reinstalled later. **NOTE: 2003 and 2004 models will only have two metric bolts to remove.**
7. Clamp the baseplate into place using the vise grips. Insert side plate support into frame opening to align with existing holes. Insert the 3/8-16 nut plate into the frame opening to align with 3/8-16x2" hex bolt, the 3/8" lock washer, and the 3/8" flat washer. Do this to both sides of the vehicle.

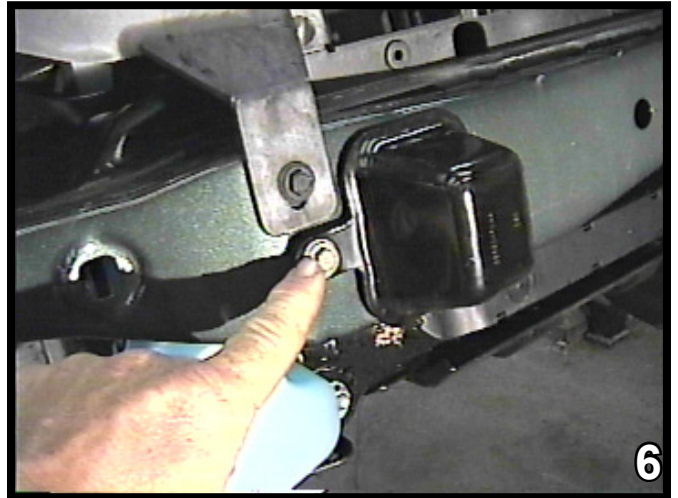

6. To remove the frame cup, use a 10MM socket to remove the metric bolt. Set cup and bolt aside to be reinstalled later. Do this to both sides of the vehicle. Some models may have tow hooks that will be removed at this time.

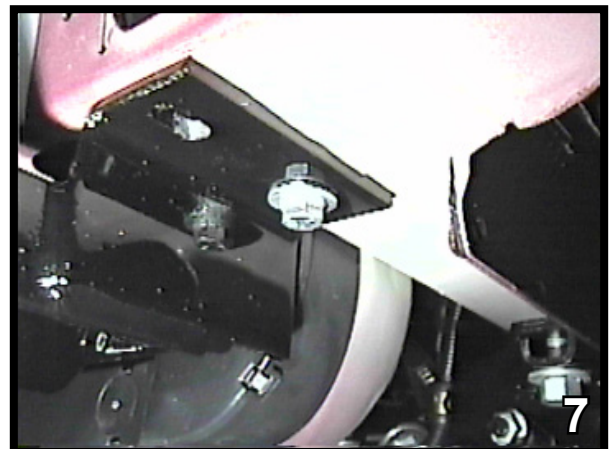

8. Reinstall the frame cups, front fascia and grille. Replacement rivets are provided for the fender wells.

BX1119
2002-04 Jeep Liberty
Installation Instructions

BE SURE TO USE LOCTITE® RED ON ALL BOLTS BEFORE TIGHTENING. TIGHTEN ALL BOLTS ACCORDING TO THE TORQUE CHART ON THE FRONT PAGE OF THESE INSTRUCTIONS OR ON PAGE 3 OF THE BASEPLATE TOWING GENERAL INSTRUCTIONS.

Install the tow bar and safety cables according to their instructions. When demonstrating this to the customer, be sure to include all of the Blue Ox packaging and contents.

DO NOT substitute other devices if the tow bar pins and clips are misplaced.

DEALER or INSTALLER:

Be certain the user receives the instruction sheets for their products.



If the baseplate is in an accident, it must be replaced. **DO NOT** use it again! An accident can cause unseen damage and using it again could result in more damage or serious injury. **DO NOT** use the baseplate if it is damaged or missing parts.

Be sure that **ALL** electrical connections are plugged in properly and functioning **BEFORE** Installing the fascia.

CUSTOMER SERVICE COMMITMENT

Blue Ox is committed to providing you with exceptional customer care throughout your lifetime with our products. Our team is here to assist you with any questions you may have regarding the performance of your product. Simply call 1-800-228-9289 and you can speak with our customer care team.

Additionally, please visit our website to see which rallies our Destination America team will be attending. For a nominal fee, our service technician will service your towing system to ensure it's in proper working condition. Also as a commitment to our customers, should you visit our factory you can stay at our full service Blue Ox campground at no charge along with enjoying a factory tour.

Again thank you for being our customer and for the confidence you have shown in the performance of our products. It is because of customers like you we enjoy the success we have today.



© 2005, 07, 08, 09 Blue Ox
One Mill Road, Industrial Park
Pender, Nebraska 68047
Phone: (402) 385-3051
Toll Free: (888) 425-5382
Fax: (402) 385-3360
www.blueox.com