



BX1123

2005-10 Jeep Grand Cherokee Installation Instructions

Serial Number

Please read **BOTH** these Installation Instructions and the General Towing Instructions before attempting to install or operate this equipment.

- Blue Ox® towing products and accessories are intended to be installed by Blue Ox® Dealers who are familiar with our products and have the equipment and knowledge to do “fit work”. When necessary Blue Ox® Dealers can be found at www.blueox.com or by contacting our Customer Care Department at (402) 385-3051.
- Many Blue Ox® Baseplates are designed to use existing holes and hardware to mount the baseplate to the towed vehicle. Even though bolts are there, do not assume they are adequate for baseplate mounting. Always use hardware supplied in the hardware kit or existing hardware specified in the Baseplate Towing Installation Instructions.

Attachment Tab Height: 19”
Attachment Tab Width: 18-3/4”

Bolt Torque Specifications		
Torque in Foot-Pounds for Metric Bolts		
Bolt Size	Grade 8.8	Grade 10.9
6MM	6	8
8MM	16	22
10MM	31	40
12MM	54	70
14MM	89	117

Confirm the towability and pre-towing procedures for your vehicle with the owner’s manual or contact the vehicle’s manufacturer for specific towing procedures.

Bolt Torque Specifications		
Torque in Foot-Pounds for Inch Bolts		
Bolt Size	Grade 5	Grade 8
1/4”	10	14
5/16”	19	29
3/8”	33	47
7/16”	54	78
1/2”	78	119
5/8”	154	230



WARNING

Failure to read and follow these instructions could result in separation of the towed vehicle from the tow bar, causing property damage, loss of towed vehicle, personal injury or death.

BX1123
2005-10 Jeep Grand Cherokee
Installation Instructions

Parts List

Ref. No.	Qty.	Part #	Description
1	1	61-6078	Baseplate BX1123
2	4	61-5208	3/8" Nut Plate w/ 14" Wire
3	4	201-0440	3/8"-16 x 1-1/2" Hex Bolt, Grade 5, ZP
4	4	201-0443	3/8"-16 x 1" Hex Bolt, Grade 5, ZP
5	8	203-0010	3/8" Lock Washer
6	4	202-0003	3/8"-16 Hex Nut, ZP
7	1	201-0702	6MM-1.00 x 45MM Hex Bolt, Grade 8.8, ZP
8	1	201-0569	1/4"-20 x 3/4" Hex Bolt, Grade 5, ZP
9	2	203-0008	1/4" Lock Washer, ZP
10	2	203-0001	1/4" Flat Washer, ZP
11	1	202-0001	1/4"-20 Hex Nut, ZP
12	6	203-0003	3/8" Flat Washer, ZP
13	2	201-0979	#12-14 x 1" Self Drilling Screw, ZP
14	2	201-0192	#10-32 x 1/2" Slot, Rd. Hd. Screw
15	2	203-0054	#10 Lock Washer
16	2	202-0047	#10-32 Hex Nut
17	2	101-5822	4 Way Connector Adapter
18	2	62-3468	Attachment Tab
	2	226-0046 (not shown)	36" Class III Safety Cable
	2	229-0359 (not shown)	3/8" Quicklink, ZP
	4	229-0536 (not shown)	6.33MM Plastic Rivets
	2	290-0437 (not shown)	Black Receiver Cap Plug
E	1		Existing Metric Bolt for Horn Bracket (PS)

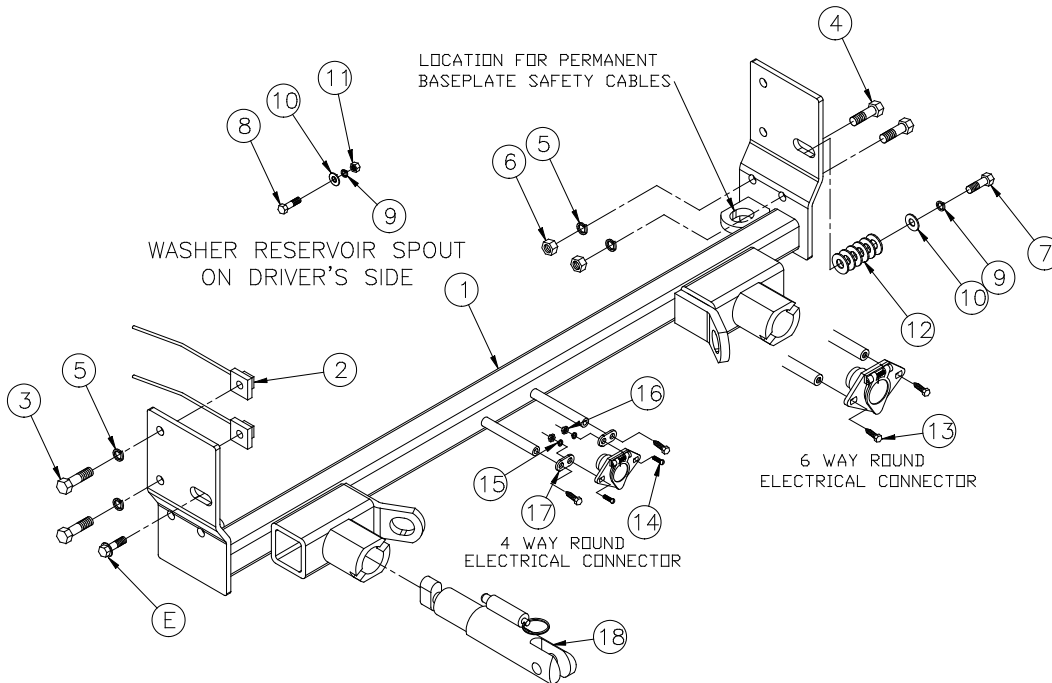

- Tools Required**
- 7MM Socket
 - 10MM Socket
 - 13MM Socket
 - 9/16" Socket
 - 13/32" Drill Bit
 - Phillips Screwdriver
 - Diagonal Cutter
 - Plastic Pop Rivet Tool
 - Vise Grip
 - Loctite® RED

Important:

Use only genuine factory replacement parts on your baseplate. Do **NOT** substitute homemade or non-typical parts. If a bolt is lost or in need of replacement, for your safety and the preservation of your baseplate, be sure to use a replacement bolt of the same grade (In most cases it will be Grade 5, please reference the parts list above). Replacement parts may be ordered through your nearest Blue Ox® Dealer or Distributor.

BX1123
2005-10 Jeep Grand Cherokee
Installation Instructions

Removable Tabs:

Motorhome mount tow bars are recommended for use with this baseplate. Due to the design of the removable tabs, the RangeFinderII, Adventurer, and Ambassador tow bars can not be used. The Acclaim tow bar may be used, but will not fold and store on the front of the vehicle. Adapters, except the BX8833 and BX88151, can not be used with this baseplate.

Instructions:

The black plastic rivet cover above the grille, front grille, front fascia, grille, front fascia, frame caps, tow hooks, horn bracket and windshield washer reservoir are removed and reinstalled during the baseplate installation. TOW HOOKS WILL NOT BE REINSTALLED. Drilling is required.

The dimensional variations between otherwise identical vehicles can be considerable. While the baseplate was designed for easy installation, it may be necessary to tailor the baseplate slightly to compensate for auto manufacturer's tolerances. These minor adjustments may include filing a hole slightly, bending electrical rods, and/ or bending end plates.

The BX8869 Bulb and Socket Wiring Kit is recommended for this vehicle.

Installation Instructions



1. Remove the six (6) pushpins from the black plastic cover on the top side of the fascia. Lift cover up and set aside to be reinstalled later. Pull top of grille forward. Lift up and set aside with pushpins to be reinstalled later.



2. Using the diagonal cutters, remove two (2) rivets from the wheel well cover just forward of the front tires. Do this to both sides of the vehicle. These rivets will be replaced.



BX1123
2005-10 Jeep Grand Cherokee
Installation Instructions



3. Using a 7MM socket, remove one (1) metric bolt from just forward of the front tire, on the fascia's corner. Do this to both sides of the vehicle. Set the bolts aside to be reinstalled later.



4. Remove four (4) pushpins from the top of the front fascia. Set pushpins aside to be reinstalled later.



5. Using the 10MM socket, remove three (3) metric bolts from the lower radiator cross member. Pull the fascia forward, unplug the electrical connections. Set the fascia and the bolts aside carefully to be reinstalled later.



6. Using the 10MM socket to remove one (1) metric bolt. Do this to both sides of the vehicle. Set metric bolts aside to be reinstalled later. Remove the tow hook assembly with the 12MM socket. The tow hooks will **NOT** be reinstalled.

BX1123
2005-10 Jeep Grand Cherokee
Installation Instructions

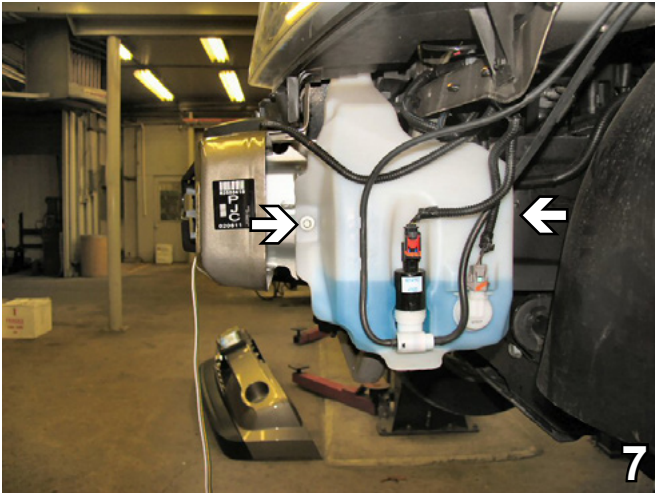

7. Using the 10MM socket, remove two (2) metric bolts from the washer reservoir on driver's side, unplug the electrical connections, disconnect and plug fluid lines. Set bolts aside to be reinstalled later

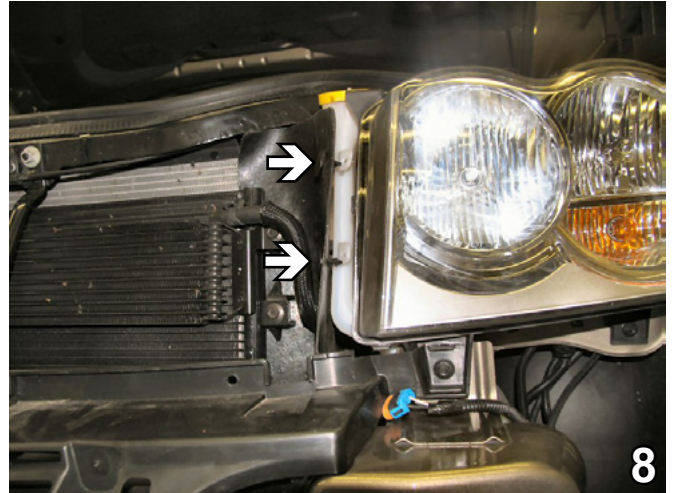

8. Remove two (2) christmas tree pushpins from the washer reservoir spout and air dam just inside of the headlight assembly on the driver's side.

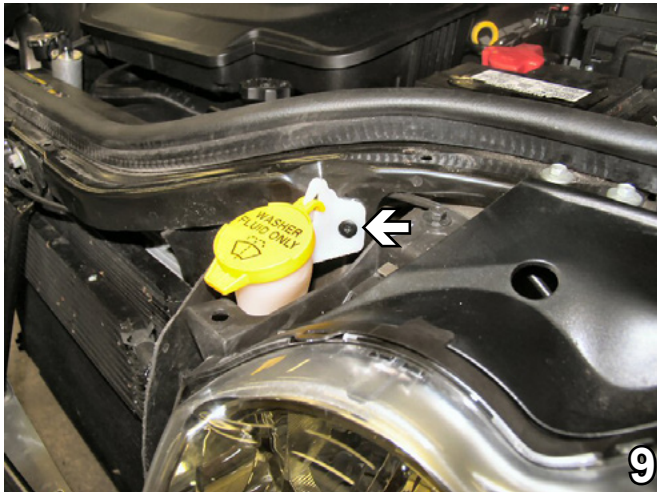

9. Remove a rivet from the reservoir spout with the diagonal cutters, pull reservoir down and set aside to be reinstalled later.



10. Remove the metric bolt from the horn bracket on the passenger's side with the 13MM socket, unplug the electrical and set horn assembly aside.

BX1123
2005-10 Jeep Grand Cherokee
Installation Instructions

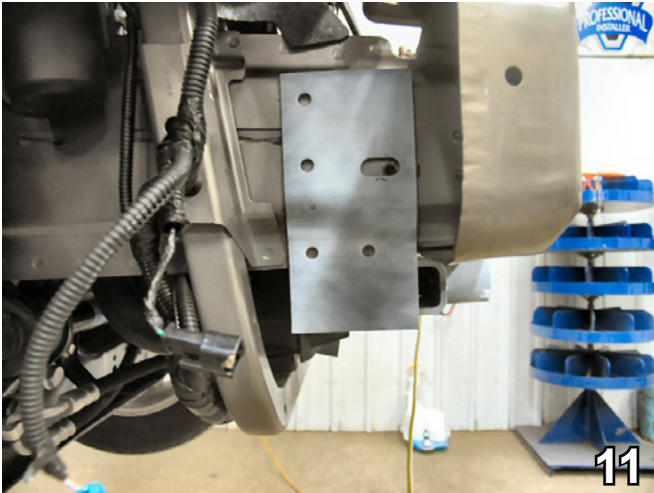

11. Slide the baseplate on to the frame rail to align with the existing hole for the horn bracket on the passenger's side and front bolt location for the reservoir on the driver's side. Using the existing bolts for horn bracket and reservoir, tighten the baseplate to the frame. **BE SURE THE BASEPLATE IS AS FAR FORWARD AS POSSIBLE BEHIND THE BUMPER BRACKET AND LEVEL WITH THE FRAME.** Slide the fascia on to the vehicle to make sure the baseplate comes through the opening properly and adjust as needed.



12. Using the baseplate as a template, drill **ALL** holes with the 13/32" drill bit. Do this to both sides of the vehicle.

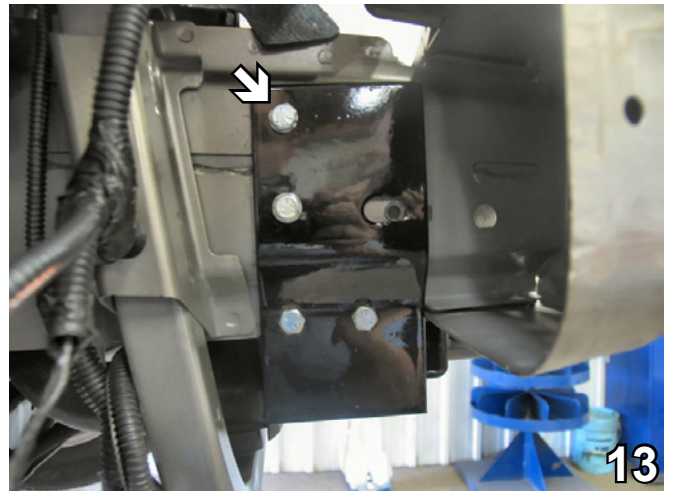

13. Insert the two (2) nut plates into the end of the frame rail to align with the top two (2) drilled holes, tighten the 3/8"-16 hex bolt and lock washer with the 9/16" socket. Do this to both sides of the vehicle.

BE SURE TO USE LOCTITE® RED ON ALL BOLTS BEFORE TIGHTENING. TIGHTEN ALL BOLTS ACCORDING TO THE TORQUE CHART ON THE FRONT PAGE OF THESE INSTRUCTIONS OR ON PAGE 3 OF THE BASEPLATE TOWING GENERAL INSTRUCTIONS.

BX1123
2005-10 Jeep Grand Cherokee
Installation Instructions

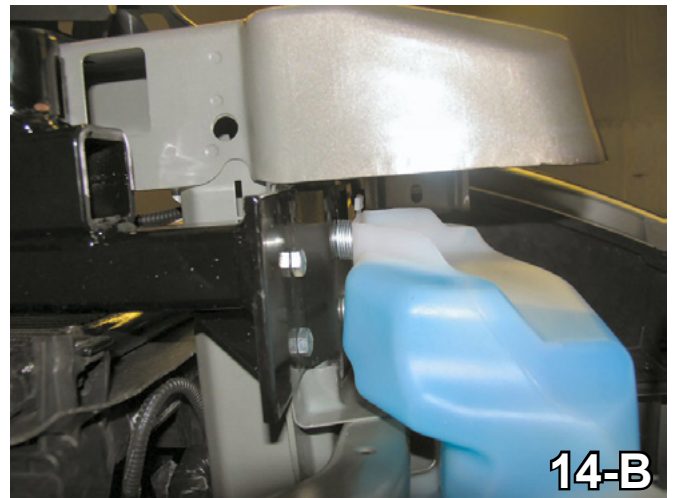
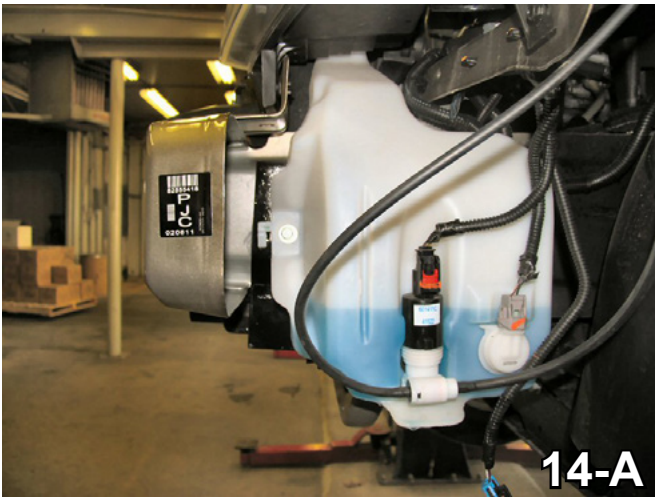

14. Align washer reservoir to its original position and install the existing backing bolt. Insert the 6MM-1.00 x 45MM hex bolt, 1/4" lock washer into the front washer reservoir bolt location, slide six (6) 3/8" flat washers between reservoir and baseplate, tighten to its original position (do **not** over tighten).

BE SURE TO USE LOCTITE® RED ON ALL BOLTS BEFORE TIGHTENING. TIGHTEN ALL BOLTS ACCORDING TO THE TORQUE CHART ON THE FRONT PAGE OF THESE INSTRUCTIONS OR ON PAGE 3 OF THE BASEPLATE TOWING GENERAL INSTRUCTIONS.



15. Tighten the 1/4"-20 x 3/4" bolt and flat washer into the existing bolt hole of upper reservoir spout. Tighten the 1/4" lock washer and hex nut on to the back side of the radiator support.

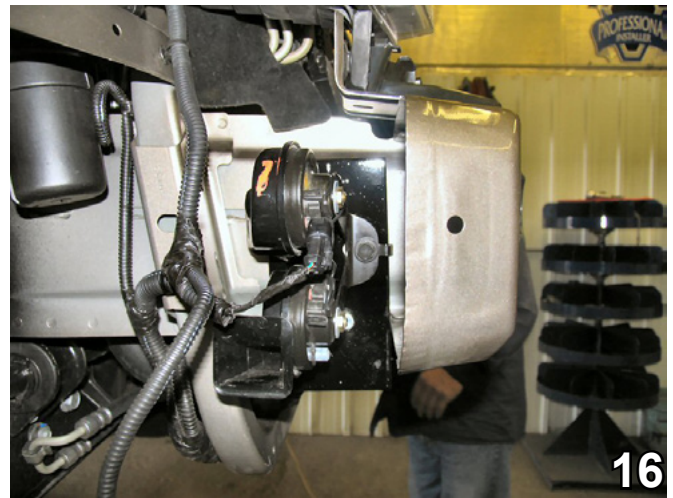

16. Reinstall the horn assembly on the passenger's side using the existing metric bolt.
17. Reinstall the frame caps, fascia, grille and black plastic cover.

Be sure that ALL electrical connections are plugged in properly and functioning BEFORE Installing the fascia.

BX1123
2005-10 Jeep Grand Cherokee
Installation Instructions

DEALER or INSTALLER:

Be certain the user receives the instruction sheets for their products.

Install the tow bar and safety cables according to the instructions in their packages.

Do **NOT** substitute other devices if the tow bar pin and clip are lost.



If the baseplate is in an accident, it must be replaced. DO NOT use it again! An accident can cause unseen damage and using it again could result in more damage or serious injury. DO NOT use the baseplate if it is damaged or missing parts.

CUSTOMER SERVICE COMMITMENT

Blue Ox is committed to providing you with exceptional customer care throughout your lifetime with our products. Our team is here to assist you with any questions you may have regarding the performance of your product. Simply call 1-800-228-9289 and you can speak with our customer care team.

Additionally, please visit our website to see which rallies our Destination America team will be attending. For a nominal fee, our service technician will service your towing system to ensure it's in proper working condition. Also as a commitment to our customers, should you visit our factory you can stay at our full service Blue Ox campground at no charge along with enjoying a factory tour.

Again thank you for being our customer and for the confidence you have shown in the performance of our products. It is because of customers like you we enjoy the success we have today.



© 2006, 07, 08, 09 Blue Ox
One Mill Road, Industrial Park
Pender, Nebraska 68047
Phone: (402) 385-3051
Toll Free: (800)228-9289
Fax: (402) 385-3360
www.blueox.com
10/20/09