



## Baseplate Installation Instructions

# BX1300 2000-01 BMW 325i Installation Instructions

Serial Number

Please read **BOTH** these Installation Instructions and the General Towing Instructions before attempting to install or operate this equipment.

- Blue Ox® towing products and accessories are intended to be installed by Blue Ox® Dealers who are familiar with our products and have the equipment and knowledge to do “fit work”. When necessary Blue Ox® Dealers can be found at [www.blueox.us](http://www.blueox.us) or by contacting our 24/7 Customer Care Department at (402) 385-3051 or Toll Free at (888) 425-5382.
- Many Blue Ox® Baseplates are designed to use existing holes and hardware to mount the baseplate to the towed vehicle. Even though bolts are there, do not assume they are adequate for baseplate mounting. Always use hardware supplied in the hardware kit or existing hardware specified in the Baseplate Towing Installation Instructions.

**Attachment Tab Height:** 17 3/4”

**Attachment Tab Width:** 24”

### Bolt Torque Specifications

Torque in Foot-Pounds per Metric Bolts

Bolt Size	Grade 8.8	Grade 10.9
6MM	6	8
8MM	16	22
10MM	31	40
12MM	54	70
14MM	89	117

Confirm the towability and pre-towing procedures for your vehicle with the owner’s manual or contact the vehicle’s manufacturer for specific towing procedures. You can also contact REMCO for additional information at 1(800)228-2481.



### Bolt Torque Specifications

Torque in Foot-Pounds per Inch Bolts

Bolt Size	Grade 5	Grade 8
1/4”	10	14
5/16”	19	29
3/8”	33	47
7/16”	54	78
1/2”	78	119
5/8”	154	230

## **WARNING**

Failure to read and follow these instructions could result in separation of the towed vehicle from the tow bar, causing property damage, loss of towed vehicle, personal injury or death.

# BX1300 2000-01 BMW 325i Installation Instructions

## Parts List

Ref. No.	Qty.	Part #	Description
1	1	61-5526	Weldment, Baseplate, BX1300
2	4	61-5208	Weldment, 3/8" Nutplate, 1" x 1" with 14" Wire
3	10	201-0440	3/8-16 x 1 1/2" Hex Bolt, Grd. 5, ZP
4	10	203-0010	3/8" Lock Washer, ZP
5	6	202-0003	3/8-16 Hex Nut, ZP
6	2	62-3468	Removable Attachment Tab, Assembly, SF/SB
7	2	201-0979	#12-14 x 1" Self Drilling Screw, ZP
8	2	101-5822	Adapter, 4 Way Connector
9	2	202-0047	#10-32 Hex Nut
10	2	203-0054	#10 Lock Washer
11	2	201-0192	#10-32 x 1/2" Slot, Rd. Hd. Screw
12	1	201-0204	1/4-20 x 1 1/4" Hex Bolt, Grade 5
13	1	203-0008	1/4" Lock Washer
14	1	202-0001	1/4" Hex Nut, ZP
	2	226-0046	Baseplate Safety Cable, 36" CL III (Not Shown)
	2	229-0359	Quicklink, 3/8, ZP (Not Shown)
	2	290-0437	Cap Plug, Black (Not Shown)

## Tools Required

10MM Wrench  
8MM Wrench  
3/8" Drill Bit  
Utility Knife  
Vise Grips  
Tape Measure  
Phillips Screwdriver  
Loctite® RED

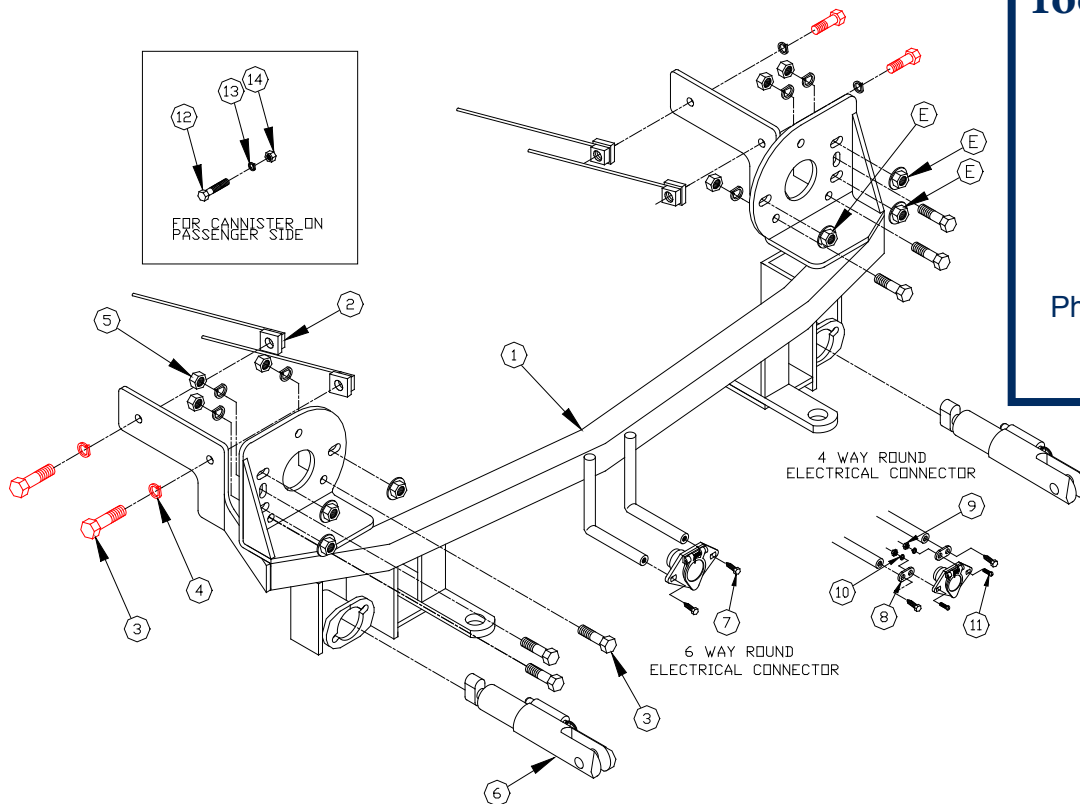

### Important:

Use only genuine factory replacement parts on your baseplate. Do **NOT** substitute homemade or non-typical parts. If a bolt is lost or in need of replacement, for your safety and the preservation of your baseplate, be sure to use a replacement bolt of the same grade (In most cases it will be Grade 5, please reference the parts list above). Replacement parts may be ordered through your nearest Blue Ox® Dealer or Distributor.

# BX1300

## 2000-01 BMW 325i

### Installation Instructions

#### Removable Tabs:

Motorhome mount tow bars are recommended for use with this baseplate. Due to the design of the removable tabs, the RangeFinder II, Adventurer and Ambassador tow bars can not be used. The Acclaim tow bar may be used, but will not fold and store on the front of the vehicle. Adapters, except for the BX8833 and the BX88151, can not be used.

#### Instructions:

The grille, front fascia, tow hooks and frame rail cups are removed for the baseplate installation. Drilling is required. The tow hooks will be removed and will NOT be reinstalled.

The dimensional variations between otherwise identical vehicles can be considerable. While the baseplate was designed for easy installation, it may be necessary to tailor the baseplate slightly to compensate for auto manufacturer's tolerances. These minor adjustments may include filing a hole slightly, bending electrical rods, and/ or bending end plates.

The BX8869 Bulb and Socket Wiring Kit is recommended for this vehicle.

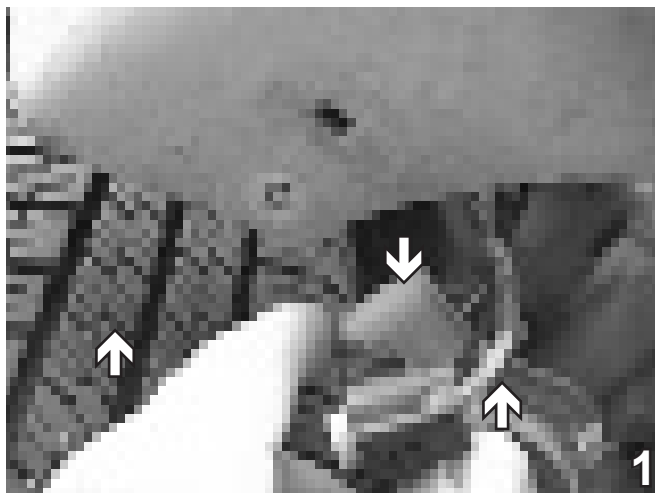

1. Remove the screws and pushpins from the underside of the bumper fascia. Set screws and pushpins aside to be reinstalled later.



2. Remove the #12 Torx bolts from below the headlight. Do this on both sides of the vehicle. Set bolts aside to be reinstalled later. Unplug the running lights, and pull the fascia forward from the vehicle. Set the fascia carefully aside to be reinstalled later.

BX1300  
2000-01 BMW 325i  
Installation Instructions



3. Remove lower plastic that is connected to the fender well molding. Unplug each sensor and set the fender well molding aside to be reinstalled later. Do this to both sides of the vehicle.



4. Remove the 8MM bolts and Phillips screws holding the air intakes to the brakes. The front of the intake will be trimmed to allow the baseplate to be installed. Set the bolts and Phillips screws aside to be reinstalled later.

BX1300  
2000-01 BMW 325i  
Installation Instructions

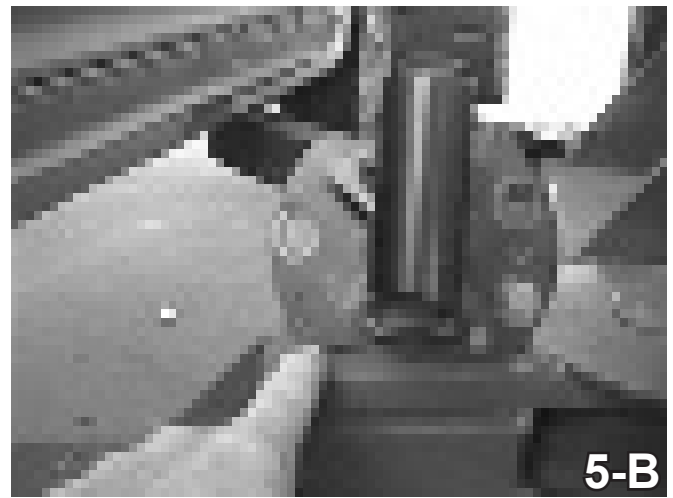

5. Remove the two front bumper brackets. There are three nuts holding each piece. The pop rivets need to be drilled out. The lower ridge where the pop rivet is will need to be trimmed off. Set the nuts aside to be reinstalled later.



6. Remove the passenger's side headlight only. There are four 8MM bolts, two on the top and two on the bottom that hold it in place. Disconnect the electrical wiring and set headlight assembly and bolts aside to be reinstalled later.

BX1300  
2000-01 BMW 325i  
Installation Instructions



7. Remove the two bolts holding the canister exposed when the headlight is removed. The baseplate will be placed between the canister and the frame and then the canister will be bolted onto the baseplate. The lower clip is removed and 1/4" hardware is used to refasten the canister to the lower hole.



8. Trim each air intake to allow for the baseplate installation. Once each are trimmed replace the air intake to its original position.

**BE SURE TO USE LOCTITE® RED ON ALL BOLTS BEFORE TIGHTENING. TIGHTEN ALL BOLTS ACCORDING TO THE TORQUE CHART ON THE FRONT PAGE OF THESE INSTRUCTIONS OR ON PAGE 3 OF THE BASEPLATE TOWING GENERAL INSTRUCTIONS.**



9. Place the baseplate up to the vehicle setting the front pieces on the existing bolts from where the bumper bracket were removed in Step 4. Use the existing nuts. See the drawing on page 2 of this document.

BX1300  
2000-01 BMW 325i  
Installation Instructions

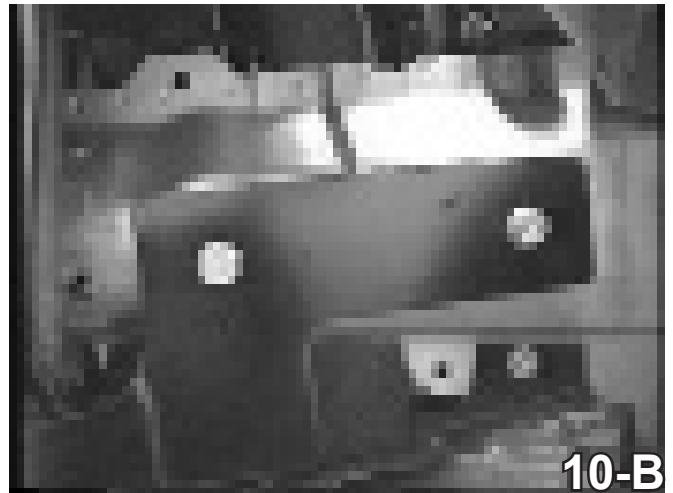

10. Drill the two 3/8" holes for each side of the vehicle using the baseplate as a template. Use the hardware shown in the drawing on page 2 of this document. The wire nut plates are inserted through the front opening of the frame. Tighten according to the chart in the Baseplate General Towing Instructions.

**BE SURE TO USE LOCTITE® RED ON ALL BOLTS BEFORE TIGHTENING. TIGHTEN ALL BOLTS ACCORDING TO THE TORQUE CHART ON THE FRONT PAGE OF THESE INSTRUCTIONS OR ON PAGE 3 OF THE BASEPLATE TOWING GENERAL INSTRUCTIONS.**

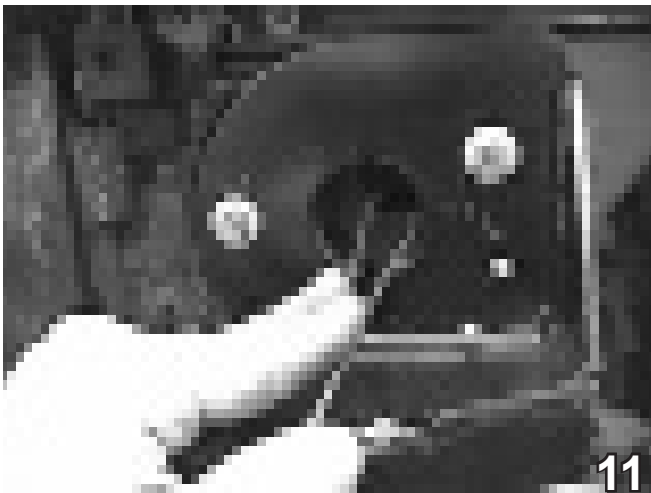

11. Cut the wires flush with the holes so the bumper brackets can be replaced.

12. Remove the bolts from the front of the baseplate and replace the bumper brackets.

BX1300  
2000-01 BMW 325i  
Installation Instructions

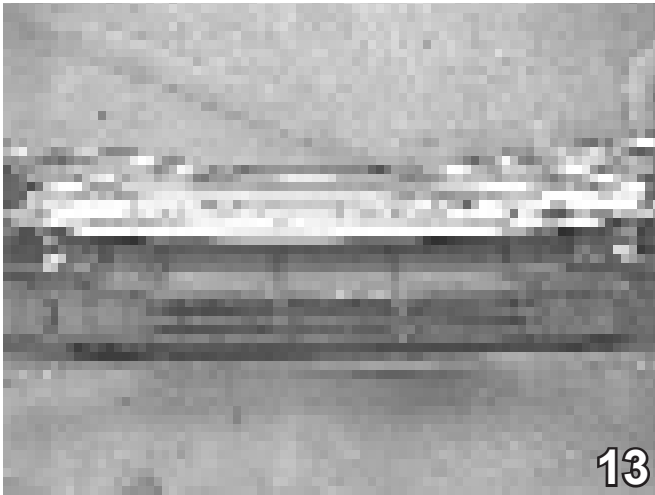

13. Measure the distance between the two holes where the long Torx bolts held the bumper fascia. Set the bumper brackets at the measured distance and hand tighten the bolts.

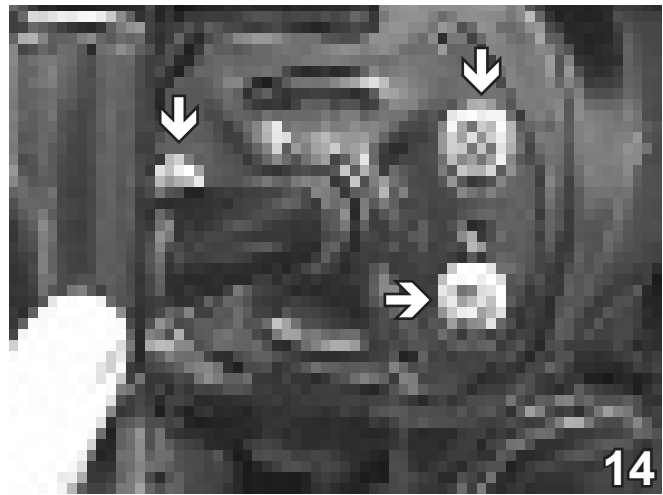

14. Drill one 3/8" hole between the two nuts on the outside of the brackets and one below the lower nut. Also drill one hole below the nut on the inside of the bumper bracket. Use the 3/8" hardware as shown in the drawing on page 2. Tighten ALL bolts. Do this to both sides of the vehicle.



15. The rivet holes are left open.



16. The two outside grille pieces need to be removed (snapped into place) to allow the attachment tabs to be used. Keep the pieces for when the car is not being towed.



BX1300  
2000-01 BMW 325i  
Installation Instructions

Be sure that **ALL** electrical connections are plugged in properly and functioning **BEFORE** Installing the fascia.

**DEALER or INSTALLER:**  
Be certain the user receives the instruction sheets for their products.

Install the tow bar and safety cables according to their instructions. When demonstrating this to the customer, be sure to include all of the Blue Ox packaging and contents.

**DO NOT** substitute other devices if the tow bar pins and clips are misplaced.

## Customer Service Commitment

Blue Ox® is focused on providing exemplary customer service, as observed in our mission statement and guiding principles. In accordance with this objective, Blue Ox® is proud to provide services such as repairs and general maintenance of Blue Ox® products at over 150 RV Rallies. Look for our Destination America or Blue Ox® Racing service crews at the next rally or NASCAR race that you attend. If you were not present, you will find an informative, personalized note explaining any services that may have been performed to your Blue Ox® products.

Blue Ox® also offers educational seminars at rallies and through our Park and Resort teams. In addition, Blue Ox® customers visiting our factory may take advantage of the well-equipped Blue Ox® RV park at no charge to you, our valued and appreciated customer.



© 2005 Blue Ox  
One Mill Road, Industrial Park  
Pender, Nebraska 68047  
Phone: (402) 385-3051  
Toll Free: (888) 425-5382  
Fax: (402) 385-3360  
[www.blueox.us](http://www.blueox.us)  
8/6/08