



BX1302

2001 & 2003 BMW 330CI

Installation Instructions

Attachment Tab Height: 15"

Attachment Tab Width: 20"

Serial Number

Please read **BOTH** these Installation Instructions and the General Instructions prior to installing or operating this equipment.

- Blue Ox® towing products and accessories are intended to be installed by Blue Ox® Dealers who are familiar with our products and have the equipment and knowledge necessary to do "fit work". If needed, Blue Ox® Dealers can be found at www.blueox.com or by contacting our Customer Care Department at (402) 385-3051.
- Many Blue Ox® baseplates are designed to use existing holes and hardware to mount the baseplate to the towed vehicle. Even though bolts are there, do not assume they are adequate for baseplate mounting. Always use the hardware supplied in the hardware kit and existing hardware as specified in the installation instructions.

Bolt Torque Specifications

Torque in Foot-Pounds for Inch Bolts

Bolt Size	Grade 5	Grade 8
1/4"	10	14
5/16"	19	29
3/8"	33	47
7/16"	54	78
1/2"	78	119
5/8"	154	230
3/4"	257	380



If the front of your vehicle looks different than this, please contact us at (402)385-3051.

Reference your vehicle owner's manual for manufacturer's towing specifications.

Bolt Torque Specifications

Torque in Foot-Pounds for Metric Bolts

Bolt Size	Grade 8.8	Grade 10.9
6MM	6	8
8MM	16	22
10MM	31	40
12MM	54	70
14MM	89	117
16MM	161	230
18MM	222	318



WARNING

Failure to read and follow these instructions could result in separation of the towed vehicle from the tow bar, causing property damage, loss of towed vehicle, personal injury or death.

BX1302
2001 & 2003 BMW 330Ci
Installation Instructions

Instruction Notes: The fascia is removed and reinstalled for the baseplate installation. Some drilling and trimming is required.

Place all components that are removed on a flat, sturdy surface. All items will be reinstalled unless otherwise noted after the baseplate is installed.

The dimensional variations between otherwise identical vehicles can be considerable. While the baseplate was designed for easy installation, it may be necessary to tailor the baseplate slightly to compensate for vehicle manufacturer's tolerances.

The BX8869 Tail Light Wiring Kit is recommended for this vehicle.

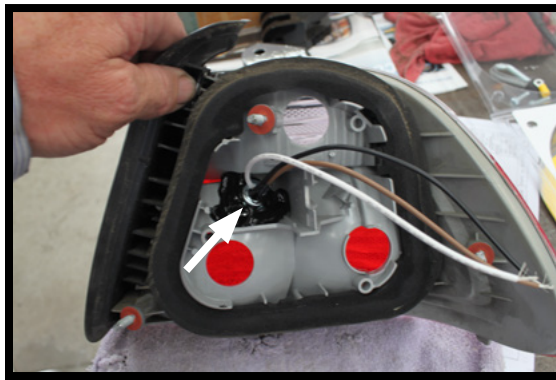

Drill a hole according to the tail
light wiring kit instructions.

NOTICE

- Handling of some cosmetic parts when installing this product may require the use of protective covers, rags, specialty tools, etc. to prevent damage.
- When using power drills be aware of the dangers of torque and drill bit length.
- When using a reciprocating saw be aware of objects behind the cutting surface.
- Use a good quality paint to spray cut edges of frame to prevent rusting.
- Be sure that **ALL** electrical connections are plugged in and accessories are functioning properly before reinstalling the fascia.
- The baseplate is computer tested to your vehicle's GVWR, exceeding this weight will void the manufacturer's warranty.
- Be sure to use Loctite® Red on all bolts before tightening. Tighten all bolts according to the torque chart provided.
- Dealer or installer be certain the user receives these instruction sheet.
- If the baseplate is in an accident, it must be replaced. **DO NOT** use it again! An accident can cause unseen damage and using it again could result in more damage or serious injury. **DO NOT** use the baseplate if it is damaged or missing parts.

BX1302 2001 & 2003 BMW 330Ci Installation Instructions

Tools Required

Large Vise Grip
Utility Knife
Phillips Screwdriver
Torque Wrench
Drill
Reciprocating Saw
Loctite® RED
13/32" Drill Bit
8MM Socket
10MM Socket
9/16" Socket
9/16" Wrench
50 Torx

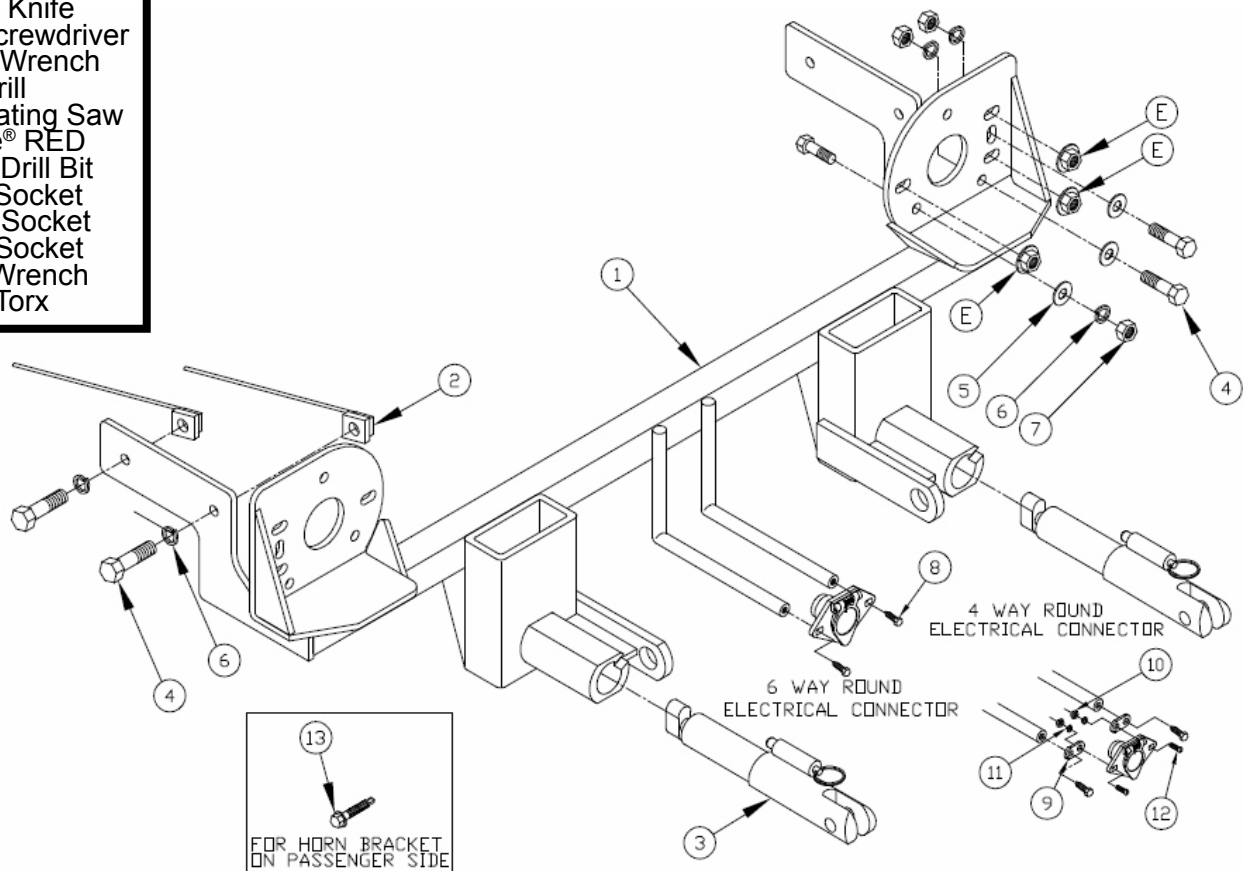

Parts List

Ref. No.	Qty.	Part No.	Description
1	1	61-5795	Weldment, Base Plate, BX1302
2	4	61-5208	Weldment, 3/8 Nut Plate 1 x 1 with 14 Inch Wire
3	2	62-3469	Removable Attachment Tab, S/F, LB
4	10	201-0440	3/8-16 x 1 1/2 Hex Bolt Grd. 5, ZP
5	6	203-0003	3/8 Flat Washer, ZP
6	10	203-0010	3/8 Lock Washer, ZP
7	6	202-0003	3/8-16 Hex Nut, ZP
8	2	201-0979	#12-14 x 1" Self Drilling Screw, ZP
9	2	101-5822	Adapter, 4 Way Connector
10	2	202-0047	#10-32 Hex Nut
11	2	203-0054	#10 Lock Washer
12	2	201-0192	#10-32 x 1/2 Slot, RD. HD. Screw
13	1	201-0654	#10-16 x 1, Self Drilling Screw
	2	226-0046	Baseplate Safety Cable, 36" CL III (Not Shown)
	2	229-0359	Quicklink, 3/8, ZP (Not Shown)
	2	290-0437	Receiver, Cap Plug (BLK) (Not Shown)

Important:

Use only genuine factory replacement parts on your baseplate. Do **NOT** substitute homemade or non-typical parts. If a bolt is lost or in need of replacement, for your safety and the preservation of your baseplate, be sure to use a replacement bolt of the same grade (In most cases it will be Grade 5, please reference the parts list above). Replacement parts may be ordered through your nearest Blue Ox® Dealer or Distributor. Failing to follow and/or altering these installation instructions in either installation or required equipment will void the manufacturer's warranty. Towing behind a non-motorized vehicle will void the warranty.

BX1302
2001 & 2003 BMW 330Ci
Installation Instructions



1. Using a T50 Torx, remove the screw from the underside of the bumper (white). Then remove the push pin (gray). Do this on both sides of the vehicle.



2. Using a 8MM socket, remove the two (2) screws from the wheel well. Do this on both sides of the vehicle.

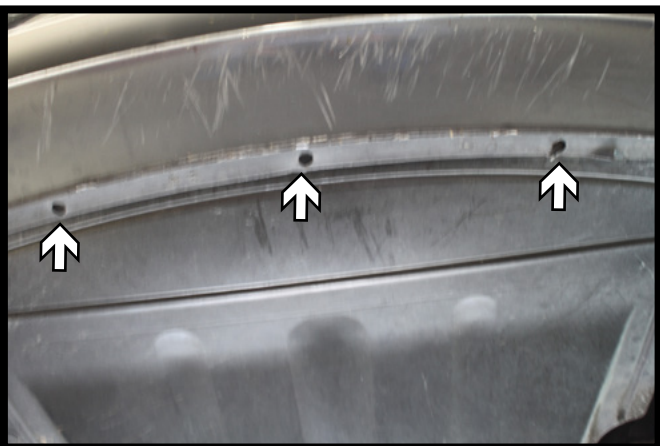

3. Remove the three (3) push pins from the underside of the fascia.



4. Using a 8MM socket, remove the four (4) screws from the corners of the fascia. There are two (2) on each side. Remove the fascia from the vehicle.

BX1302
2001 & 2003 BMW 330Ci
Installation Instructions

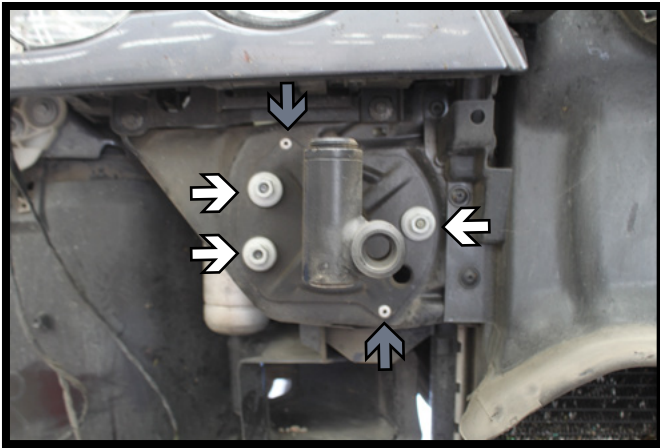

5. Using a 13MM socket, remove the three (3) nuts from the bumper support (white). Then drill out the two (2) rivets (gray). Do this on both sides of the vehicle.



6. Trim the air dam off just below the bolt heads across to allow baseplate clearance.

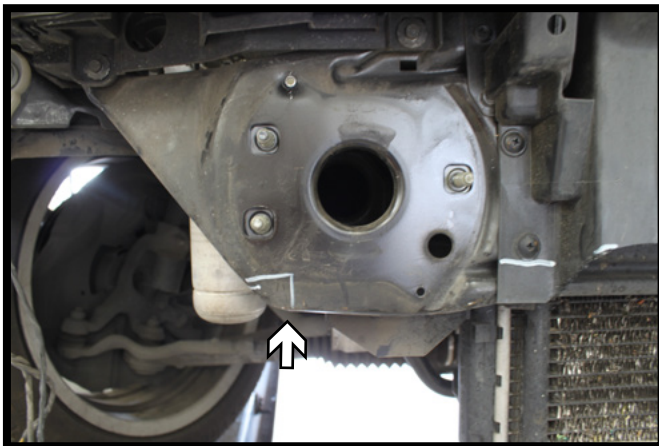

7. Using a reciprocating saw, trim a 1" x 1" notch out of the face of the frame. Do this on both sides of the vehicle.



8. On the bumper support, trim off the lower tab. Do this on both supports.

BX1302
2001 & 2003 BMW 330Ci
Installation Instructions

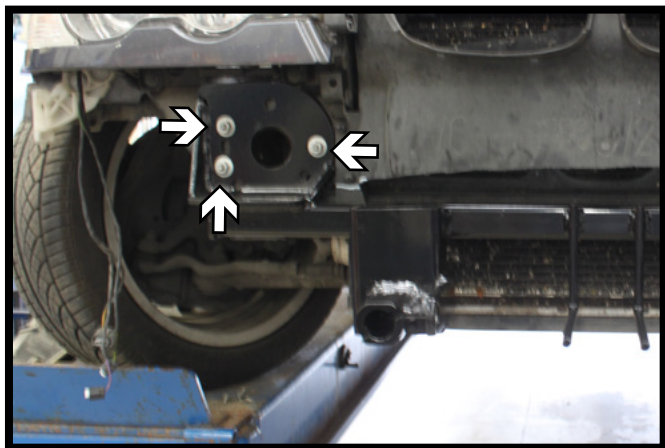

9. Attach the baseplate to the vehicle using the existing nuts. Do this on both sides of the vehicle.

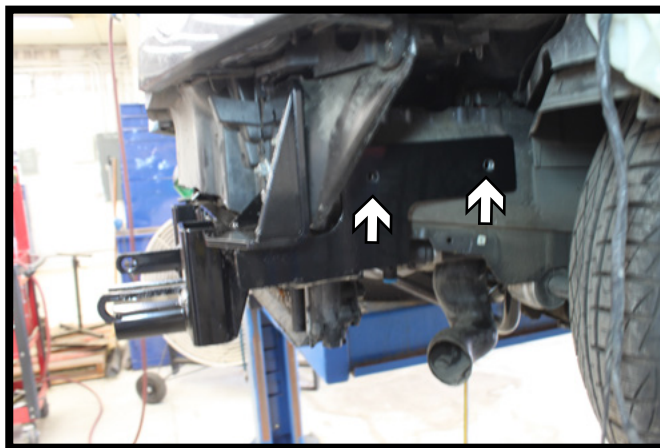

10. Using a 13/32" drill bit, drill the two (2) holes in the side of the baseplate thru the frame. Install 3/8"-16 x 1-1/2" bolts with 3/8" lock washers into the holes and 3/8"-16 nut plates on the inside of the frame. Do this on both sides of the vehicle. Fully tighten all fasteners.

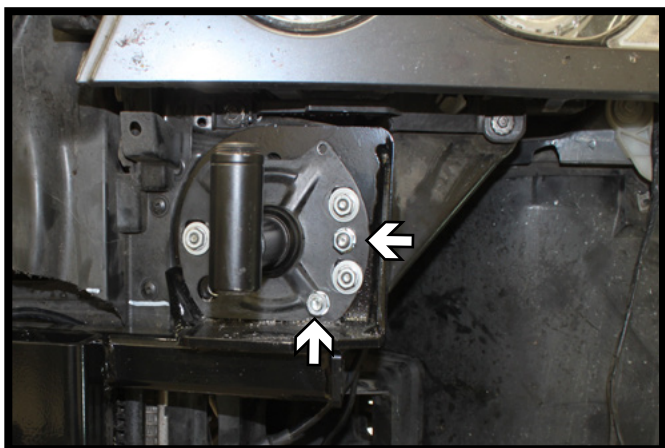

11. Remove the nuts installed previously from step #9. Using a 13/32" drill bit, drill the outer two (2) holes of the baseplate thru the face of the frame. Transfer the hole locations to the support and drill out. Reinstall the support with the existing nuts and install 3/8"-16 x 1-1/2" bolts with 3/8" flat washers into the holes and 3/8" lock washer and nut on the backside of the face. Do this on both sides of the vehicle.

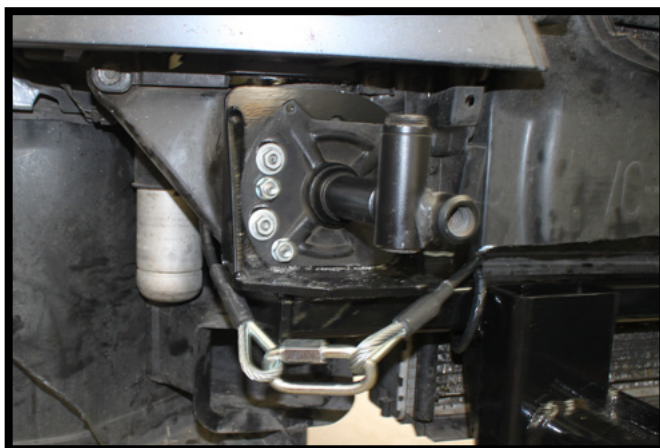

12. Attach the permanent baseplate safety cables to the provided convenience link on the baseplate. The photo above shows the recommended installation of the cables to frame of vehicle. Additional options may interfere with suggested mounting; in this case, secure the cables to a solid piece of the frame as described in the instructions included with the permanent baseplate safety cables. Be sure the safety cables do not rub against any hoses or moving parts. Do this on **BOTH** sides of the vehicle.

BX1302
2001 & 2003 BMW 330Ci
Installation Instructions



13. On the backside of the fascia, measure down from the top of the fascia approximately 7". Mark and trim an area 1" wide x 1-1/4" high for baseplate clearance.



14. Reinstall the fascia.

CUSTOMER SERVICE COMMITMENT

Blue Ox® is committed to providing you with exceptional customer care throughout your lifetime with our products. Our team is here to assist you with any questions you may have regarding the performance of your product. Simply call (402) 385-3051 and you can speak with our customer care team.

Additionally, please visit our website to see which rallies our Destination America team will be attending. For a nominal fee, our service technician will service your towing system to ensure it's in proper working condition. Also, as a commitment to our customers, should you visit our factory, you can stay at our full service Blue Ox® campground at no charge along with enjoying a factory tour.

Again, thank you for being our customer and for the confidence you have shown in the performance of our products. It is because of customers like you we enjoy the success we have today.

© 2013 Blue Ox
One Mill Road, Industrial Park
Pender, Nebraska 68047
Phone: (402) 385-3051
Fax: (402) 385-3360
www.blueox.com