



BX1312

2015-20 Mini Cooper Hardtop 2016-20 Mini Cooper Convertible (Includes S) (No JCW) Installation Instructions

Attachment Tab Height: 11"

Attachment Tab Width: 20"

Serial Number

Please read BOTH these Installation Instructions and the General Information sheet prior to installing or operating this equipment.

- Blue Ox® towing products and accessories are intended to be installed by Blue Ox® Dealers who are familiar with our products and have the equipment and knowledge necessary to do "fit work". If needed, Blue Ox® Dealers can be found at www.blueox.com or by contacting our Technical Service Department at (402) 385-3051.
- Many Blue Ox® baseplates are designed to use existing holes and hardware to mount the baseplate to the towed vehicle. Even though bolts are there, do not assume they are adequate for baseplate mounting. Always use the hardware supplied in the hardware kit and existing hardware as specified in the installation instructions.

Bolt Torque Specifications
Torque in Foot-Pounds for Inch Bolts

Bolt Size	Grade 5	Grade 8
1/4"	10	14
5/16"	19	29
3/8"	33	47
7/16"	54	78
1/2"	78	119
5/8"	154	230
3/4"	257	380



If the front of your vehicle looks different than this, please contact us at (402)385-3051.

Reference your vehicle owner's manual for manufacturer's towing specifications.

Bolt Torque Specifications
Torque in Foot-Pounds for Metric Bolts

Bolt Size	Grade 8.8	Grade 10.9
6MM	6	8
8MM	16	22
10MM	31	40
12MM	54	70
14MM	89	117
16MM	161	230
18MM	222	318

! WARNING

Failure to read and follow these instructions could result in separation of the towed vehicle from the tow bar, causing property damage, loss of towed vehicle, personal injury or death.

BX1312
2015-20 Mini Cooper Hardtop (Includes S) (No JCW)
2016-20 Mini Cooper Convertible (Includes S) (No JCW)
Installation Instructions

Instruction Notes: The fascia, horns and windshield washer fluid reservoir are removed and reinstalled for the baseplate installation. The brake ducts are removed and can be reinstalled after modification if desired. Some drilling and trimming is required.

Place all components that are removed on a flat, sturdy surface. All items will be reinstalled unless otherwise noted after the baseplate is installed.

The dimensional variations between otherwise identical vehicles can be considerable. While the baseplate was designed for easy installation, it may be necessary to tailor the baseplate slightly to compensate for vehicle manufacturer's tolerances.

The BX8848 4-Diode Wiring Kit is recommended for this vehicle.

NOTICE

- Handling of some cosmetic parts when installing this product may require the use of protective covers, rags, specialty tools, etc. to prevent damage.
- When using power drills be aware of the dangers of torque and drill bit length.
- When using a reciprocating saw be aware of objects behind the cutting surface.
- Use a good quality paint to spray cut edges of frame to prevent rusting.
- Be sure that **ALL** electrical connections are plugged in and accessories are functioning properly before reinstalling the fascia.
- The baseplate is computer tested to your vehicle's GVWR, exceeding this weight will void the manufacturer's warranty.
- Be sure to use a sufficient amount of Loctite® Red on all bolt threads before tightening. Tighten all bolts according to the torque chart provided.
- Dealer or installer be certain the user receives these instruction sheets.
- If the baseplate is in an accident, it must be replaced. **DO NOT** use it again! An accident can cause unseen damage and using it again could result in more damage or serious injury. **DO NOT** use the baseplate if it is damaged or missing parts.

BX1312

2015-20 Mini Cooper Hardtop (Includes S) (No JCW) 2016-20 Mini Cooper Convertible (Includes S) (No JCW) Installation Instructions

Tools Required

Utility Knife
Torque Wrench
Drill
Reciprocating Saw
Tape Measure
Loctite® RED
3/8" Drill Bit
8MM Socket
10MM Socket
18MM Socket
9/16" Socket
9/16" Wrench
T30 Torx

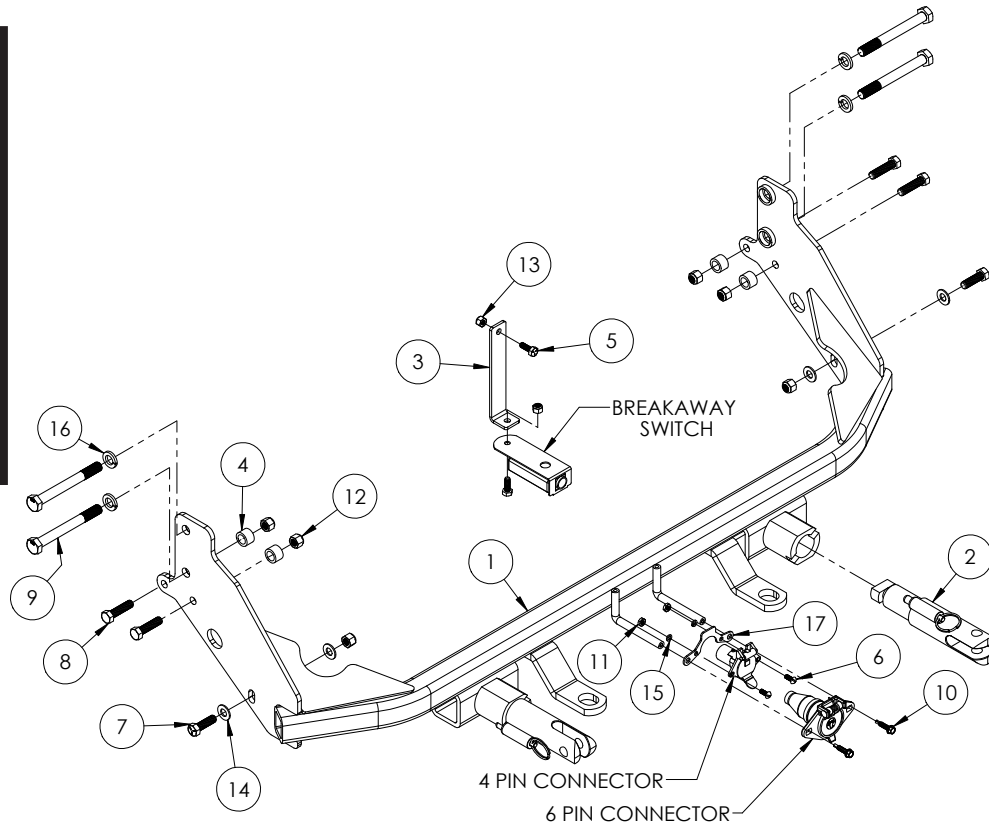

Item No.	Part No.	Description	Qty.
1	61-7487	BX1312 Baseplate	1
2	62-3468	Attachment Tab Assembly with Hole	2
3	102-7582	Breakaway Bracket	1
4	107-1801	3/4" Spacer Tube	4
5	201-0050	1/4"-20 x 3/4" Hex Head Bolt, Grade 5, ZP	2
6	201-0192	#10-32 1/2" Round Slotted Head Screw	2
7	201-0368	3/8"-16 x 1-1/4" Hex Head Bolt, Grade 5, ZP	2
8	201-0440	3/8"-16 x 1-1/2" Hex Head Bolt, Grade 5, ZP	4
9	201-0588	12MM-1.5 x 110MM Hex Head Bolt, ZP	4
10	201-0979	#12-14 x 1" Self Drilling Screw, ZP	2
11	202-0047	#10-32 Hex Nut	2
12	202-0090	3/8"-16 Hex Nylon Insert Lock Nut, ZP	6
13	202-0102	1/4"-20 Hex Nylon Nut, ZP	2
14	203-0003	3/8" Flat Washer, ZP	4
15	203-0054	#10 Lock Washer, ZP	2
16	203-0105	12MM Lock Washer, ZP	4
17	299-0685	4-Way Bracket	1
18	226-0046(not shown)	Class III Safety Cables	2
19	229-0359(not shown)	3/8" Quicklink, ZP	2
20	290-0437(not shown)	Black Cap Plug Receiver	2

Important:

Use only genuine factory replacement parts on your baseplate. Do **NOT** substitute homemade or non-typical parts. If a bolt is lost or in need of replacement, for your safety and the preservation of your baseplate, be sure to use a replacement bolt of the same grade (In most cases it will be Grade 5, please reference the parts list above). Replacement parts may be ordered through your nearest Blue Ox® Dealer or Distributor. Failing to follow and/or altering these installation instructions in either installation or required equipment will void the manufacturer's warranty. Towing behind a non-motorized vehicle will void the warranty.

BX1312

2015-20 Mini Cooper Hardtop (Includes S) (No JCW) 2016-20 Mini Cooper Convertible (Includes S) (No JCW) Installation Instructions

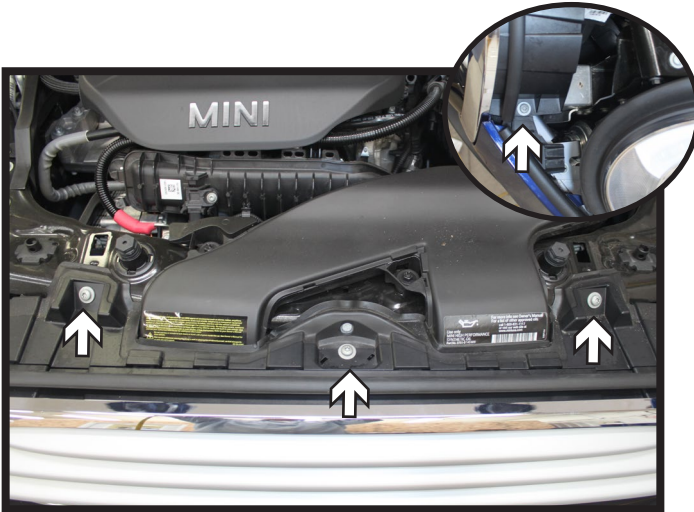

1. Using a T30 Torx, remove the three (3) screws from the top edge of the fascia. Then remove the two (2) screws next to the headlights, there is one (1) on each side (inset).



2. Using a 8MM socket, remove the screw from the outer edge of the wheel well. Do this on both sides of the vehicle.

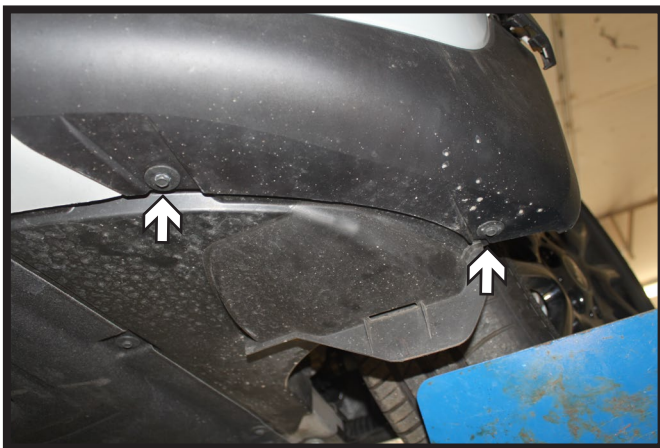

3. Using a 8MM socket, remove the seven (7) screws from the underside of the fascia.



4. Pry the fender flare away from vehicle. Using a T30 Torx, remove the screw from behind the fender flare. Do this on both sides of the vehicle.

Pull the corners of the fascia away from the vehicle disconnecting any electrical connections and set the fascia aside.

BX1312
2015-20 Mini Cooper Hardtop (Includes S) (No JCW)
2016-20 Mini Cooper Convertible (Includes S) (No JCW)
Installation Instructions

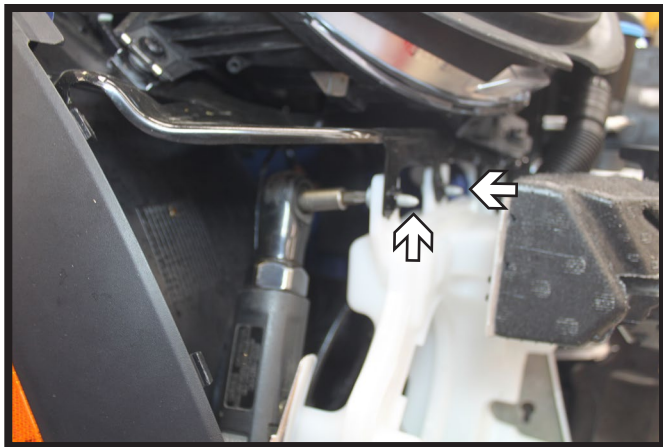

5. Using a T30 Torx, remove the two (2) screws from the washer reservoir. Disconnect/Plug all lines and set the reservoir aside.



6. On the driver side, using a T30 Torx, remove the two (2) screws from the horn bracket. Disconnect all lines and set the horn assembly aside.

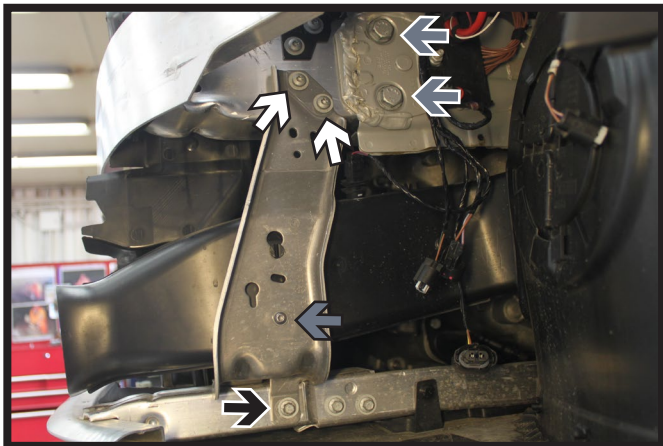

7. Using a T30 Torx, remove the two (2) screws from the top of the support bracket (white). Using a T25 Torx, remove the screw from the duct (gray). Using a 8MM socket, remove the bolt from the bottom of the support bracket (black).
Using a 18MM socket, remove the two (2) frame bolts (gray/white).
Do this on both sides of the vehicle.

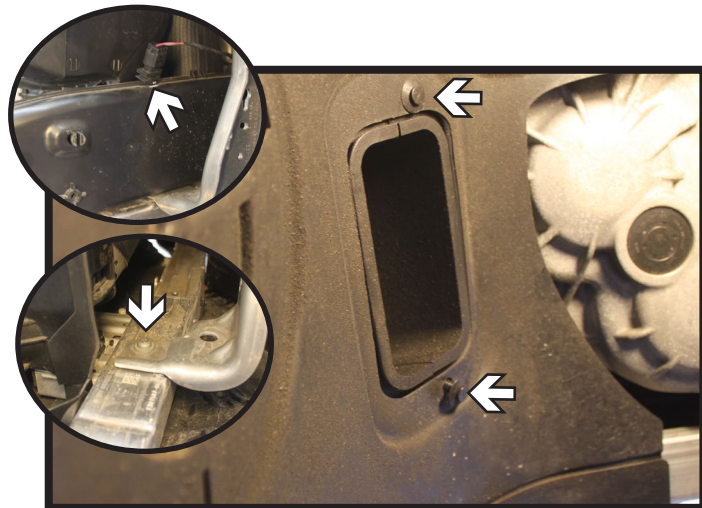

8. In the wheel well, remove the two (2) push pins from the backside of the duct. Remove the duct from the vehicle.
Note: on the driver side, remove the temperature sensor from the duct prior to removing from the vehicle (upper inset).
Using a T30 Torx, remove the lower screw from the brace and set the brace aside (lower inset).
Do this on both sides of the vehicle.

BX1312

2015-20 Mini Cooper Hardtop (Includes S) (No JCW) 2016-20 Mini Cooper Convertible (Includes S) (No JCW) Installation Instructions



9. Trim the plastic shielding as shown on both sides of the vehicle for baseplate clearance.

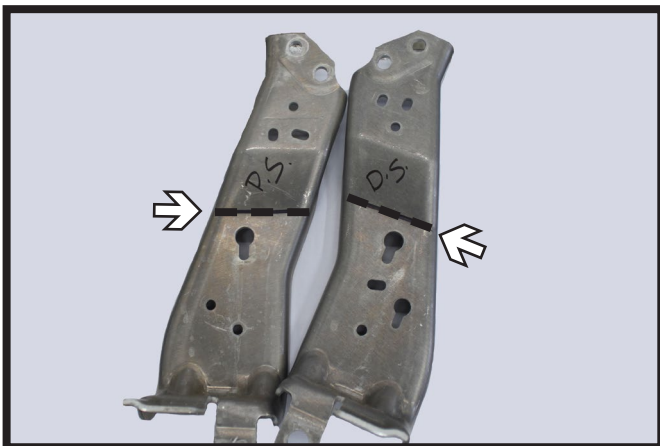

11. Trim off the upper section of the support brackets as shown.
12. Reinstall the support bracket with the existing bolts. If needed mark the backside of the bracket where the existing hole in the baseplate hits. Remove the bracket and drill the hole with a 3/8" bit. Reinstall the bracket using the existing bolts and a 3/8"-16 x 1-1/4" bolt and lock nut through the baseplate.
Do this on both sides of the vehicle. Fully tighten all hardware.

**** Use Loctite® Red on all bolt threads and tighten all bolts to the appropriate torque.**

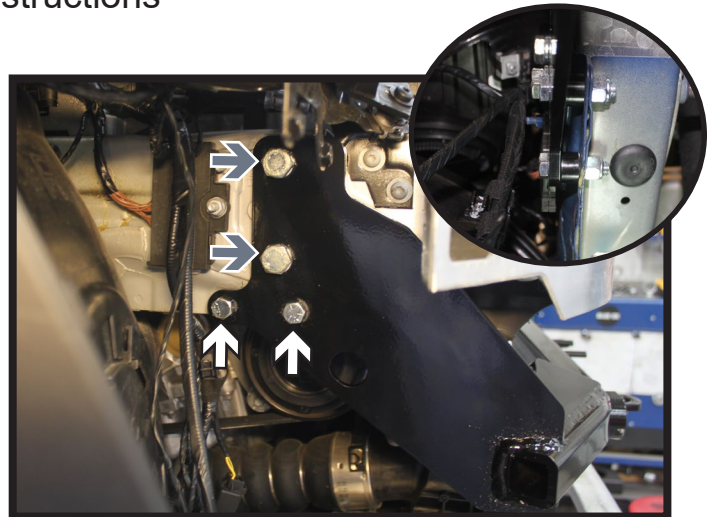

10. Install the baseplate to the vehicle using the existing frame holes with the supplied 12MM bolts and lock washers (gray). Level and fully tighten all bolts.

Using a 3/8" drill bit, drill the lower mounting holes thru the frame. Install the 3/8"-16 x 1-1/2" bolts and 3/8" lock nuts with the spacer tubes in between frame and baseplate (inset).

Do this on both sides of the vehicle. Fully tighten all hardware.

**** Use Loctite® Red on all bolt threads and tighten all bolts to the appropriate torque.**

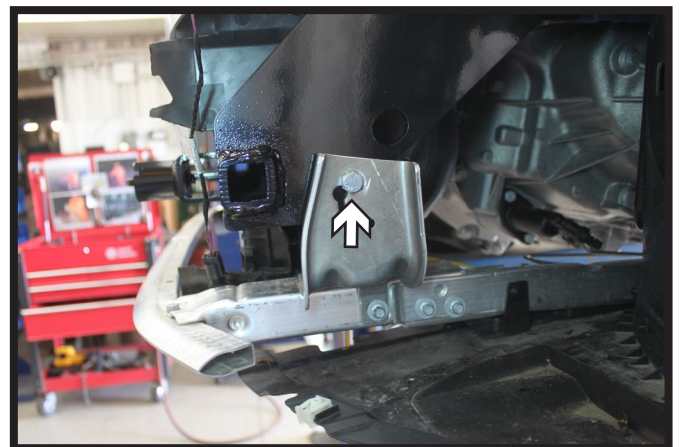

BX1312
2015-20 Mini Cooper Hardtop (Includes S) (No JCW)
2016-20 Mini Cooper Convertible (Includes S) (No JCW)
Installation Instructions



13. Using a 10MM socket, remove the screw from the lower horn.

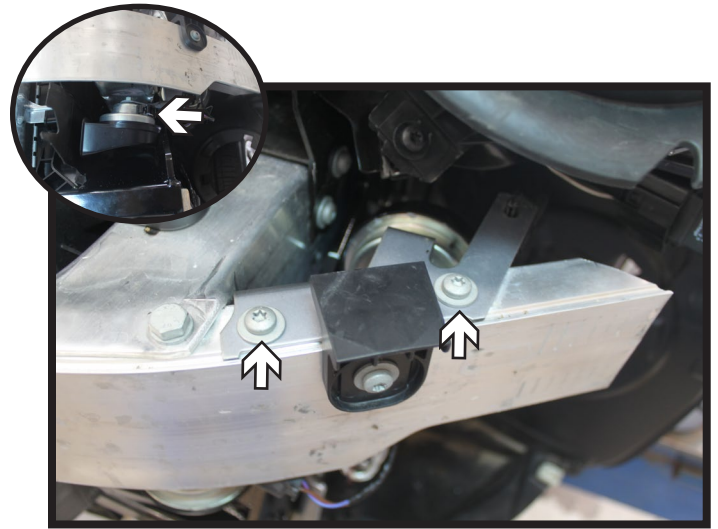

14. Leaving the lower horn loose, reinstall the bracket to the vehicle. After the bracket is reinstalled reattach the lower horn to the bracket.

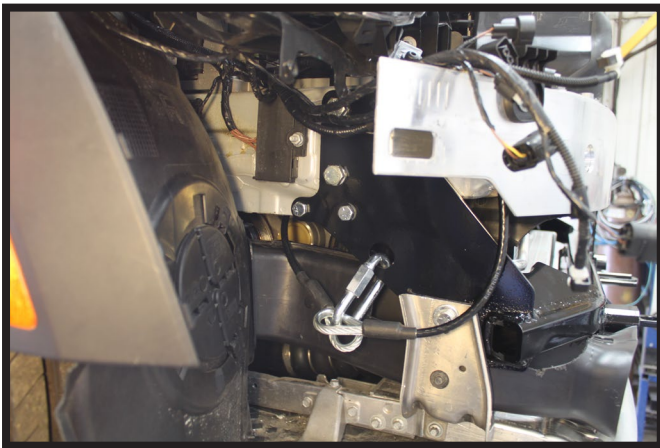

15. Attach the permanent baseplate safety cables to the convenience link hole on the baseplate. Secure the cables to a solid piece of the frame as described in the instructions included with the permanent baseplate safety cables. Be sure the safety cables do not rub against any hoses or moving parts. Do this on **BOTH** sides of the vehicle.

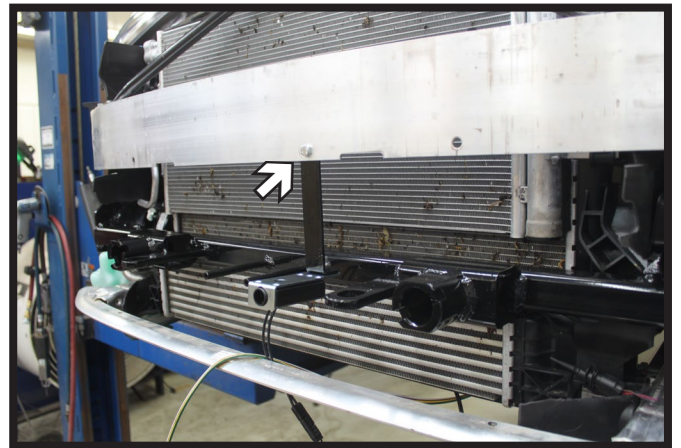

16. **Optional:** Attach the breakaway bracket to the bumper in the desired location with the supplied 1/4" hardware.

BX1312

2015-20 Mini Cooper Hardtop (Includes S) (No JCW) 2016-20 Mini Cooper Convertible (Includes S) (No JCW) Installation Instructions



17. On the driver side, ziptie the temperature sensor securely.
Trim the brake ducts as needed to clear the baseplate and reinstall to the vehicle.



18. Hold the fascia as close to its original position, mark and trim the fascia around the convenience links and attachment tabs. Reinstall the washer reservoir and fascia.

CUSTOMER SERVICE COMMITMENT

Blue Ox® is committed to providing you with exceptional customer care throughout your lifetime with our products. Our team is here to assist you with any questions you may have regarding the performance of your product. Simply call (402) 385-3051 and you can speak with our technical service team.

Additionally, please visit our website to see which rallies our Destination America team will be attending. For a nominal fee, our service technician will service your towing system to ensure it's in proper working condition. Also, as a commitment to our customers, should you visit our factory, you can stay at our full service Blue Ox® campground at no charge along with enjoying a factory tour.

Again, thank you for being our customer and for the confidence you have shown in the performance of our products. It is because of customers like you we enjoy the success we have today.

© 2015 Blue Ox
One Mill Road, Industrial Park
Pender, Nebraska 68047
Phone: (402) 385-3051
Fax: (402) 385-3360
www.blueox.com

General Information

1. Ensure that your product(s) are registered online at www.blueox.com. It is crucial to register your product(s) so that you may be alerted of product offerings, updates, upgrades, maintenance and safety bulletins, and/or recalls.
2. **It is the owner's responsibility to inspect all towing equipment for cracked welds, missing or worn parts and loose bolts before each towing trip.** Be sure to use Loctite® Red on all bolts and tighten to the recommended specifications.
3. **It is the owner's responsibility to hook up all towing equipment per manufacturer's instructions/recommendations.**
4. Remove the attachment tabs when not in use (if applicable).

Notice To Baseplate Installer

1. It is YOUR responsibility to watch for:

- Oil cooler and air conditioner lines
- Electrical wires and hoses
- Missing parts or attaching points on the frame

** If the baseplate is improperly installed and is against a wire or hose, it could cause fluid leaks or electrical shorts some time after the actual baseplate installation.

Permanent Baseplate Safety Cable Installation

Permanent baseplate safety cables are strongly recommended when towing a vehicle with a tow bar. The principle function of the permanent baseplate safety cables is to prevent the towed vehicle from breaking loose in the event the connection between the frame of the towed vehicle and the baseplate fails or becomes disconnected. The cables must be connected from the baseplate to the frame rail or cross member of the vehicle's frame. The illustrations below show the possible arrangements recommended by Blue Ox®. Each permanent baseplate safety cable must have an adequate weight rating for the towing system. The weight rating of the two (2) cables together will not qualify.

Do not mount the permanent baseplate safety cables against wires, hoses or brake lines.

These permanent baseplate safety cables should remain installed as long as the baseplate is installed on the vehicle. Permanent baseplate safety cables are to be used in conjunction with, and NOT a replacement for legally required safety cables attaching the towed vehicle to the towing vehicle.

OPTION #1

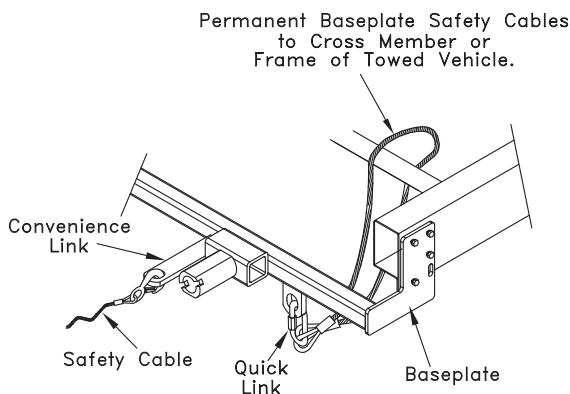

OPTION #2

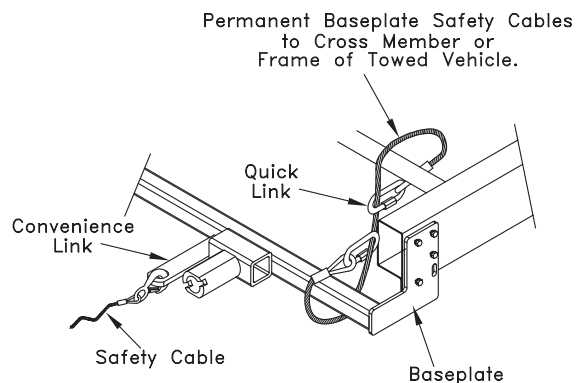

BLUE OX ORIGINAL PURCHASERS THREE YEAR LIMITED WARRANTY

Automatic Equipment Manufacturing Company ("Automatic") warrants to the original (first) retail purchaser that this product, manufactured by Automatic, shall be free from defect in material and workmanship under normal use and service for a period of three years from the date of delivery.

During said three-year period, Automatic will repair or replace any parts that have been returned by the original purchaser, to the factory, transportation prepaid, and in Automatic's sole and absolute opinion found to be defective.

Limitations on Warranty Coverage:

Coverage under this warranty will be valid only if the customer warranty card is returned by the original purchaser within 30 days of purchase.

Coverage under this warranty will be effective only when a copy of the original invoice, showing date and place of purchase, accompanies any claim for warranty. This warranty is NON TRANSFERABLE.

This limited warranty will not cover, in any way or form, any alleged damages caused by incorrect or improper installation, improper use, modification or neglect of product, failure to properly service and maintain, misuse, act of God, accident or failure of the user to follow guidelines contained in the instructional material provided by Automatic.

This warranty does not cover normal wear and tear, paint or rust.

Warrantor assumes no responsibility to the owner for loss of use of product, loss of time, inconvenience or any other damage consequential or otherwise. Including, but not limited to mileage, expense of transporting of product, return shipping expense, mechanics travel time, telephone, road service, towing, and rental during repairs, travel, lodging, loss or damage to personal property or loss of earnings.

REPAIR OR REPLACEMENT AS SET FORTH IN THIS LIMITED WARRANTY IS THE SOLE EXCLUSIVE REMEDY OF THE PURCHASER. AUTOMATIC SHALL NOT BE LIABLE FOR ANY INCIDENTAL OR CONSEQUENTIAL DAMAGES FOR BREACH OF ANY EXPRESS OR IMPLIED WARRANTY ON THIS PRODUCT. EXCEPT TO THE EXTENT PROHIBITED BY APPLICABLE LAW, ANY IMPLIED WARRANTY OF MERCHANTABILITY OR FITNESS FOR A PARTICULAR PURPOSE ON THIS PRODUCT IS LIMITED IN LENGTH TO THE DURATION OF THIS WARRANTY.

Please visit <http://blueox.com/warranty/> to register your warranty

