



BX1675

2007-12 GMC Acadia Installation Instructions

Serial Number

Please read BOTH these Installation Instructions and the General Towing Instructions before attempting to install or operate this equipment.

- Blue Ox® towing products and accessories are intended to be installed by Blue Ox® Dealers who are familiar with our products and have the equipment and knowledge to do “fit work.” When necessary, Blue Ox® Dealers can be found at www.blueox.com or by contacting our Customer Care Department at (402) 385-3051.
- Many Blue Ox® Baseplates are designed to use existing holes and hardware to mount the baseplate to the towed vehicle. Even though bolts are there, do not assume they are adequate for baseplate mounting. Always use hardware supplied in the hardware kit or existing hardware specified in the Baseplate Towing Installation Instructions.

Attachment Tab Height: 17”
Attachment Tab Width: 18”

Bolt Torque Specifications
Torque in Foot-Pounds for Metric Bolts

Bolt Size	Grade 8.8	Grade 10.9
6MM	6	8
8MM	16	22
10MM	31	40
12MM	54	70
14MM	89	117

Confirm the towability and pre-towing procedures for your vehicle with the owner’s manual or contact the vehicle’s manufacturer for specific towing procedures.

Bolt Torque Specifications
Torque in Foot-Pounds for Inch Bolts

Bolt Size	Grade 5	Grade 8
1/4”	10	14
5/16”	19	29
3/8”	33	47
7/16”	54	78
1/2”	78	119
5/8”	154	230



If the front of your vehicle looks different than this, call us at (402) 385-3051.

! WARNING

Failure to read and follow these instructions could result in separation of the towed vehicle from the tow bar, causing property damage, loss of towed vehicle, personal injury or death.

BX1675 2007-12 GMC Acadia Installation Instructions

Parts List

Ref. No.	Qty.	Part #	Description
1	1	61-6385	Weldment, Baseplate, BX1675
2	4	61-4029	Weldment, 1/2" Nut Wire, Common
3	4	201-0051	1/2-13 x 1 1/2" Hex Bolt, GRD. 5, ZP
4	4	203-0012	1/2" Lock Washer, ZP
5	2	201-0979	#12-14 x 1" Self Drilling Screw, ZP
6	2	201-0192	#10-32x1/2" Slot, Round Head Screw
7	2	203-0054	#10 Lock Washer
8	2	202-0047	#10-32 Hex Nut
9	2	101-5822	Adapter, 4 Way Connector
10	4		Existing Bolts
11	2	62-3468	Attachment, Assembly, SF/SB, 1 Hole
	2	290-0437	Cap Plug, Black (Not Shown)
	2	229-0359	Quicklink, 3/8", ZP (Not Shown)
	2	226-0046	Baseplate Safety Cable, 36" Class III (Not Shown)

Tools Required

Loctite® RED	Hack Saw Blade
Phillips Screwdriver	Reciprocating Saw
7MM Socket	1 1/4" Hole Saw
10MM Socket	9/16" Socket
15MM Socket	3/4" Socket
17/32" Drill Bit	Utility Knife
Torx 20	

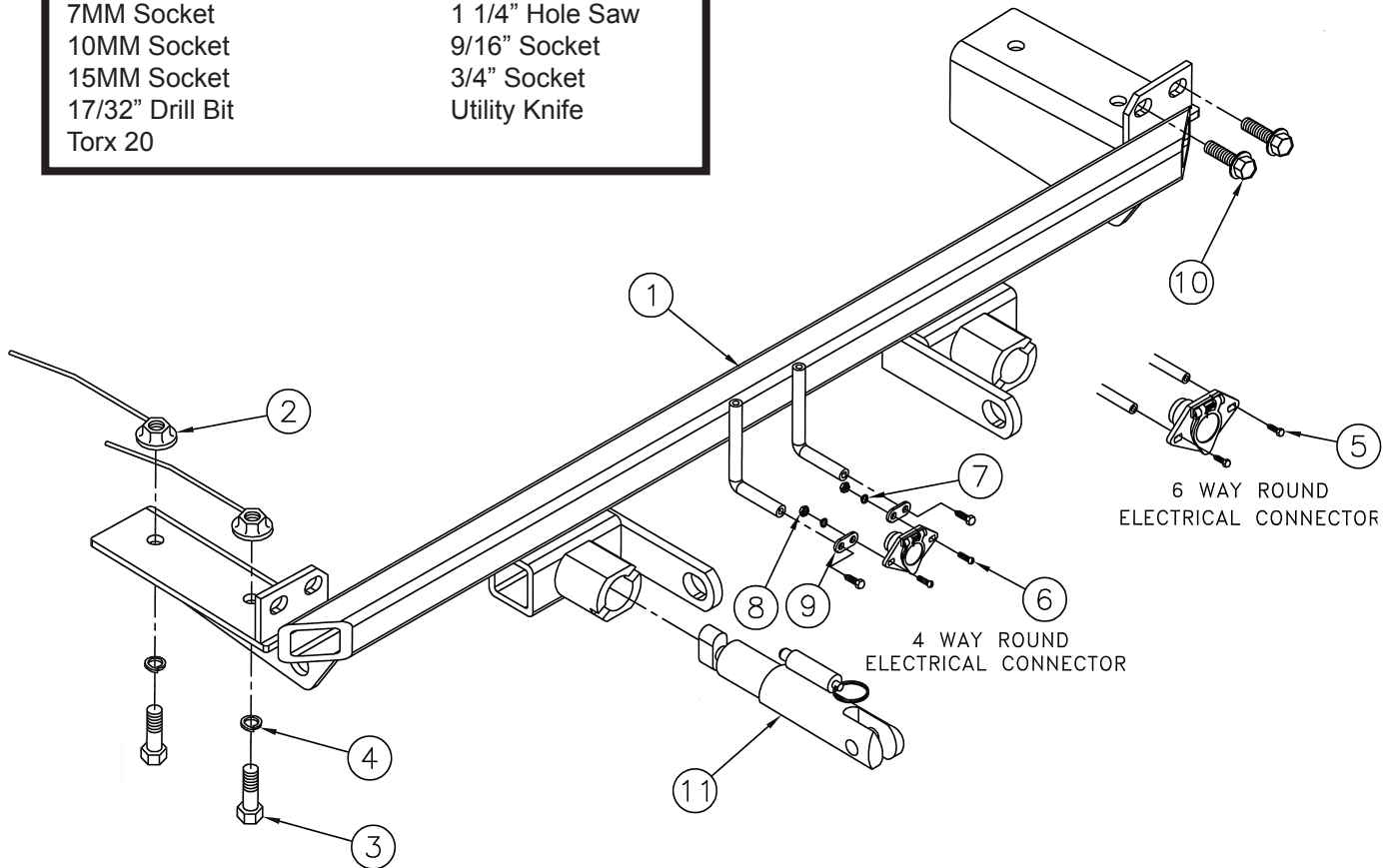

Important:

Use only genuine factory replacement parts on your baseplate. Do NOT substitute homemade or non-typical parts. If a bolt is lost or in need of replacement, for your safety and the preservation of your baseplate, be sure to use a replacement bolt of the same grade (In most cases it will be Grade 5, please reference the parts list above). Replacement parts may be ordered through your nearest Blue Ox® Dealer or Distributor. Failing to follow and/or altering these installation instructions in either installation or required equipment will void the manufacturer's warranty. Towing behind a non-motorized vehicle will void the warranty.

BX1675
2007-12 GMC Acadia
Installation Instructions

Vehicle Weight: The weight of this vehicle is near the Class III, 5,000 lb. rating limitations. Some models, depending on options, may well exceed this 5,000 lb rating. Be sure to confirm the weight of your individual vehicle before towing. As of 1999 the Aventa® II is now 10,000 lbs. and either the Aventa® II or the Aventa® LX tow bar must be used for these applications. Tow Bar Adapters are NOT to be used with vehicles weighing over 5,000 lbs.

Installation Notes: The fascia is removed and reinstalled during installation of the baseplate. Drilling is required. Trimming of the fascia is required.

The dimensional variations between otherwise identical vehicles can be considerable. While the baseplate was designed for easy installation, it may be necessary to tailor the baseplate slightly to compensate for auto manufacturer's tolerances. These minor adjustments may include filing a hole slightly, bending electrical rods or bending end plates.

The BX8848 Diode Wiring Kit is recommended for this vehicle.

Do not use the towed vehicle for storing luggage, equipment, etc. This may cause you to exceed the towing capacity of the tow bar, baseplate, and its accessories.

Handling of some cosmetic parts when installing this product may require the use of protective covers, rags, specialty tools, etc. to prevent damage.

When using power drills be aware of the dangers of torque and drill bit length.

BE SURE TO USE LOCTITE® RED ON ALL BOLTS BEFORE TIGHTENING. TIGHTEN ALL BOLTS ACCORDING TO THE TORQUE CHART ON THE FRONT PAGE OF THESE INSTRUCTIONS OR ON PAGE 3 OF THE BASEPLATE TOWING GENERAL INSTRUCTIONS.

Installation Instructions

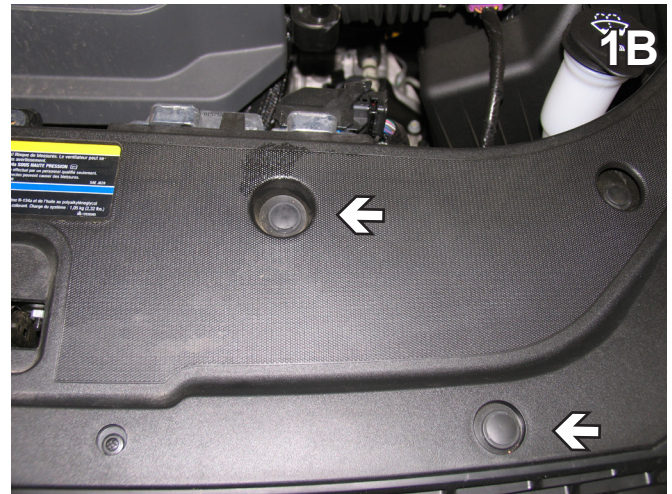

1. Using a flat screwdriver, remove three push pins from the flat plastic piece on top. Do this to both sides of the vehicle. Set push pins aside to be reinstalled later.

BX1675
2007-12 GMC Acadia
Installation Instructions

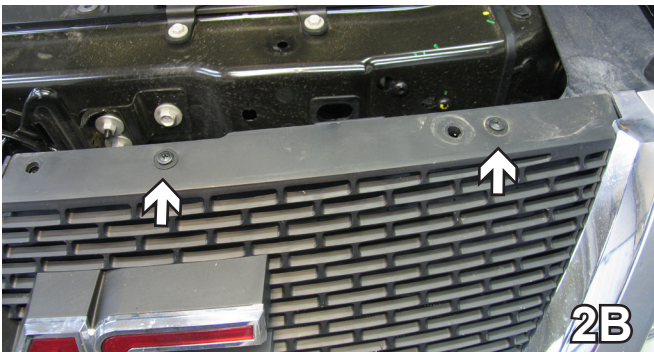

2. Once top piece is set aside, you will need to remove three (3) screws with a Phillips screwdriver and one (1) push pin with a flat screwdriver. Do this to both sides of the vehicle. Set screws and push pin aside to be reinstalled later.



4. Located just forward the front tire underneath, you will need to remove two (2) screws with a Phillips screwdriver and one (1) bolt with a 10MM socket. Do this to both sides of the vehicle. Set screws and bolts aside to be reinstalled later.



3. Using a Phillips screwdriver, remove five (5) screws just forward of the front tire, on the wheel well. Do this to both sides of the vehicle. Set screws aside to be reinstalled later.



5. Once screws are removed from wheel well, pull plastic back on top and remove one (1) metric bolt with a 7MM socket.

BX1675
2007-12 GMC Acadia
Installation Instructions



6. You will then need to pull plastic back underneath and remove two (2) metric bolts with a 7MM socket. Do this to both sides of the vehicle. Set bolts aside to be reinstalled later. The fascia is then ready to be removed from the vehicle and set aside carefully to be reinstalled later.

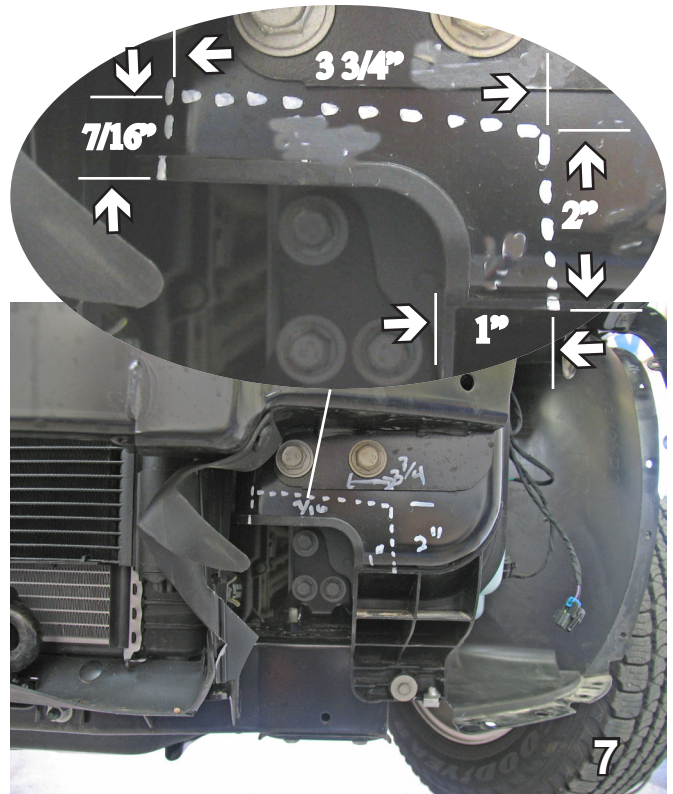

7. Mark and cut out frame according to the photo above, using a reciprocating saw. Do this to both sides of the vehicle.

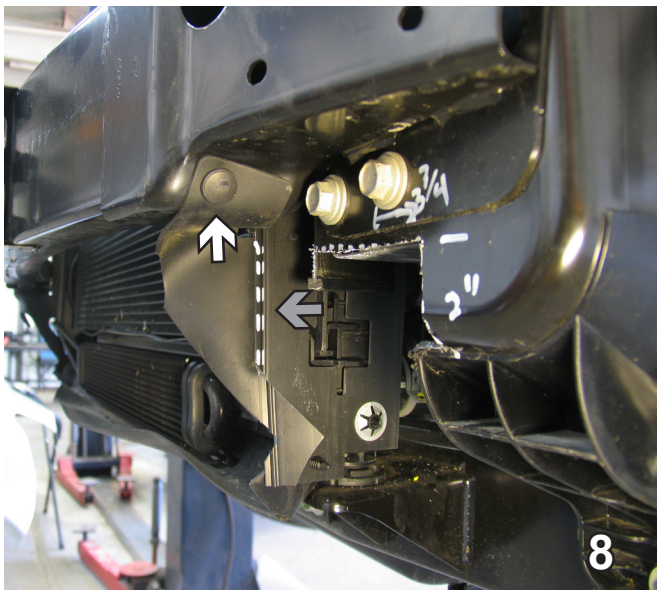

8. Using a flat screwdriver, remove push pin (see white arrow) and then using a utility knife, cut along dashed line shown in the photo above (see grey arrow). The plastic piece will not be reinstalled and can be discarded. Do this to both sides of the vehicle.

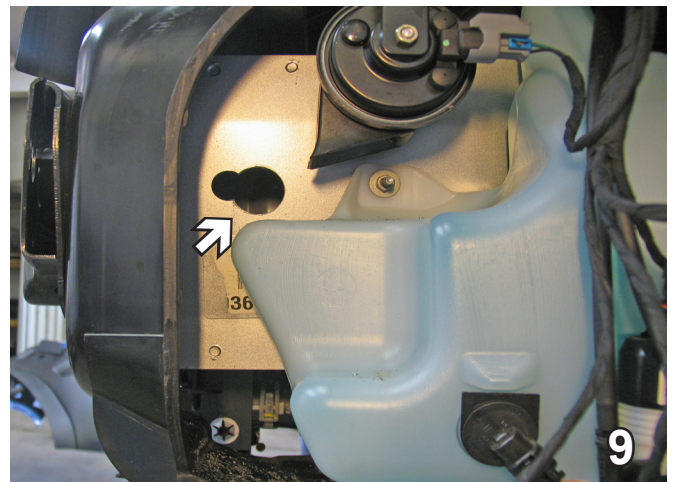

9. Drill a 1-1/4" hole into the frame, so the nut plates can go through. Do this to both sides of the vehicle.

BX1675
2007-12 GMC Acadia
Installation Instructions

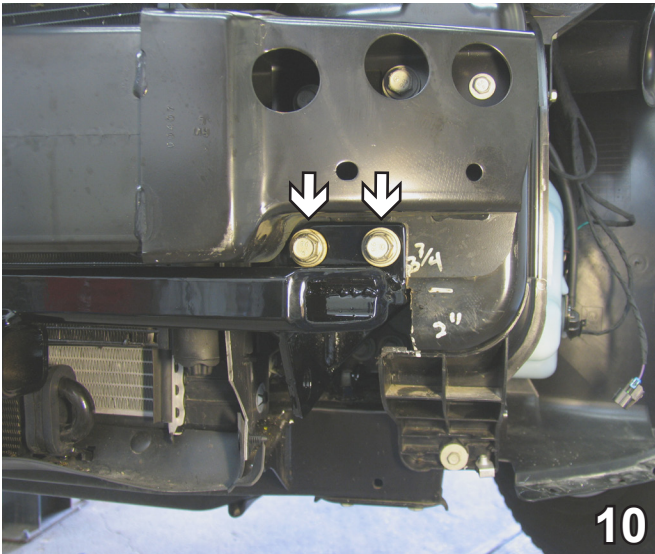

10. Using a 15MM socket, remove two (2) bolts from the front of the bumper. Do this to both sides of the bumper. Slide baseplate straight back, so that the holes on the baseplate line up with the existing holes of the bumper. Reinsert the existing bolts and tighten down, so the bolts are snug. Do this to both sides of the baseplate.

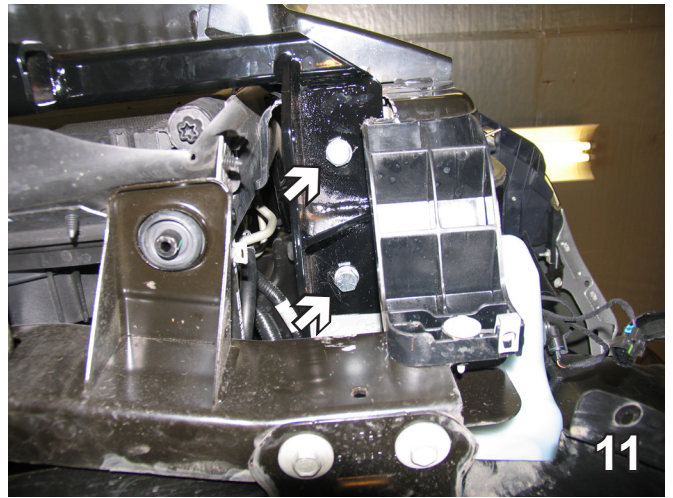

11. Using the baseplate as a template, drill the two (2) bottom holes into the frame with a 17/32" drill bit. Insert the 1/2" nut plates into the frame and align with drilled holes. Insert a 1/2"-13x1-1/2" hex bolt and 1/2" lock washer into each hole and tighten down with Loctite Red. You will then need to finish tightening down the front two (2) bolts. Do this to both sides of the baseplate.

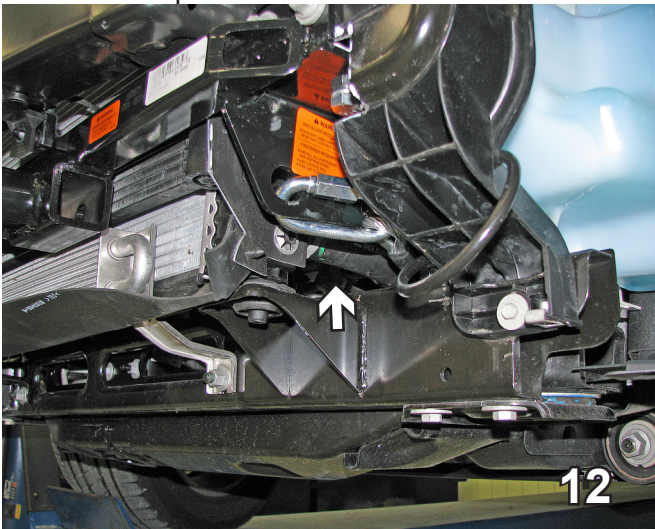

12. Attach the permanent baseplate safety cables to the provided convenience link on the baseplate. Secure the cables to a solid piece of the frame as described in the instructions included with the permanent baseplate safety cables. Be sure the safety cables do not rub against any hoses or moving parts. Do this to both sides of the vehicle.

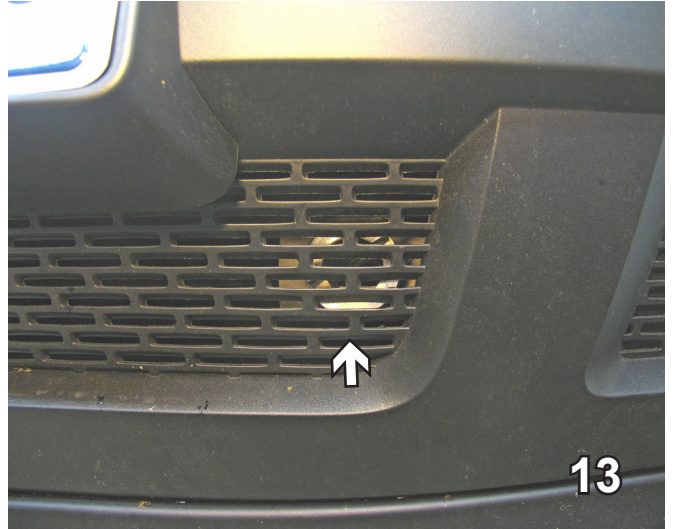

13. Align the fascia to its original position and using a hack saw blade, remove area around attachment tab receiver to allow for it to come through fascia. Do this to both sides of the vehicle.

Be sure that **ALL** electrical connections are plugged in properly and functioning **BEFORE** installing the fascia.

BX1675
2007-12 GMC Acadia
Installation Instructions

Install the tow bar and safety cables according to the instructions provided in their packages. When demonstrating this to the customer, be sure to include all the contents and packages.

Do **NOT** substitute other devices if the tow bar pins and clips are misplaced.



If the baseplate is in an accident, it must be replaced. **DO NOT** use it again! An accident can cause unseen damage and using it again could result in more damage or serious injury. **DO NOT** use the baseplate if it is damaged or missing parts.

DEALER or INSTALLER:
Be certain the user receives the instruction sheets for their products.

CUSTOMER SERVICE COMMITMENT

Blue Ox is committed to providing you with exceptional customer care throughout your lifetime with our products. Our team is here to assist you with any questions you may have regarding the performance of your product. Simply call (402) 385-3051 and you can speak with our customer care team.

Additionally, please visit our website to see which rallies our Destination America team will be attending. For a nominal fee, our service technician will service your towing system to ensure it's in proper working condition. Also, as a commitment to our customers, should you visit our factory, you can stay at our full service Blue Ox campground at no charge along with enjoying a factory tour.

Again, thank you for being our customer and for the confidence you have shown in the performance of our products. It is because of customers like you we enjoy the success we have today.



© 2011 Blue Ox
One Mill Road, Industrial Park
Pender, Nebraska 68047
Phone: (402) 385-3051 • Fax: (402) 385-3360
www.blueox.com