



**BLUE OX**

Baseplate Installation Instructions

**BX1687**

# 2008 Chevy Aveo Includes Foglights Installation Instructions

Serial Number

**Please read BOTH these Installation Instructions and the General Towing Instructions before attempting to install or operate this equipment.**

- Blue Ox® towing products and accessories are intended to be installed by Blue Ox® Dealers who are familiar with our products and have the equipment and knowledge to do “fit work.” When necessary, Blue Ox® Dealers can be found at [www.blueox.com](http://www.blueox.com) or by contacting our Customer Care Department at (402) 385-3051.
- Many Blue Ox® Baseplates are designed to use existing holes and hardware to mount the baseplate to the towed vehicle. Even though bolts are there, do not assume they are adequate for baseplate mounting. Always use hardware supplied in the hardware kit or existing hardware specified in the Baseplate Towing Installation Instructions.

Attachment Tab Height: 13.5”

Attachment Tab Width: 17”

### Bolt Torque Specifications

Torque in Foot-Pounds for Metric Bolts

Bolt Size	Grade 8.8	Grade 10.9
6MM	6	8
8MM	16	22
10MM	31	40
12MM	54	70
14MM	89	117

**Confirm the towability and pre-towing procedures for your vehicle with the owner’s manual or contact the vehicle’s manufacturer for specific towing procedures.**

### Bolt Torque Specifications

Torque in Foot-Pounds for Inch Bolts

Bolt Size	Grade 5	Grade 8
1/4”	10	14
5/16”	19	29
3/8”	33	47
7/16”	54	78
1/2”	78	119
5/8”	154	230



**If the front of your vehicle looks different than this, call us at (402) 385-3051.**

## **! WARNING**

Failure to read and follow these instructions could result in separation of the towed vehicle from the tow bar, causing property damage, loss of towed vehicle, personal injury or death.

# BX1687

## 2008 Chevy Aveo (Includes Foglights)

### Installation Instructions

#### Parts List

Ref. No.	Qty.	Part #	Description
1	1	61-6660	WLDM'T, BP, BX1687
2	4	107-3117	SPACER TUBE, 3/4 OD X .406 ID X 1/2"
3	2	107-1753	SPACER TUBE, 3/4 OD X .406 ID X 3/4"
4	6	61-5208	WLD, NUT PLT, 1/4X1X1, 3/8" WITH 14"WIRE
5	4	201-0368	3/8-16 X 1 1/4 HEX HEAD BOLT, GRADE 5
6	4	201-0444	3/8-16 X 2 HEX BOLT GRADE 5, ZP
7	2	201-0440	3/8-16 X 1 1/2 HEX BOLT, GRADE 5, ZP
8	10	203-0010	3/8 LOCK WASHER, ZP
9	4	202-0090	3/8-16 HEX NYL. INS. LOCK NUT, ZP
10	1	201-0448	1/4-20 X 1 1/2 HEX BOLT GRADE 5 ZP
11	1	203-0001	1/4 FLAT WASHER, ZP
12	1	203-0008	1/4 LOCK WASHER, ZP
13	1	202-0001	1/4-20 HEX NUT
14	2	201-0979	#12-14 x 1" Self Drilling Screw, ZP
15	2	201-0192	10-32 X 1/2 SLOT, ROUND HEAD SCREW
16	2	203-0054	#10 LOCK WASHER
17	2	202-0047	#10-32 HEX NUT
18	2	101-5822	ADAPTER, 4 WAY CONNECTOR
19	2	62-3469	ATT TAB ASSY, REM, SF/LB, 1 HOLE
	2	226-0046	BASEPLATE SAFETY CABLE, 36" CL III (Not Shown)
	2	229-0359	QUICKLINK, 3/8, ZP (Not Shown)
	2	290-0437	RECEIVER, CAP PLUG (BLK) (Not Shown)

#### Tools Required

7MM Socket/Wrench  
 10MM Socket/Wrench  
 9/16" Socket/Wrench  
 Reciprocating Saw  
 Drill  
 Flat Screwdriver  
 Phillips Screwdriver  
 Utility Knife  
 Tape Measure  
 1 1/4" Hole Saw  
 13/32" Drill Bit  
 Loctite® RED

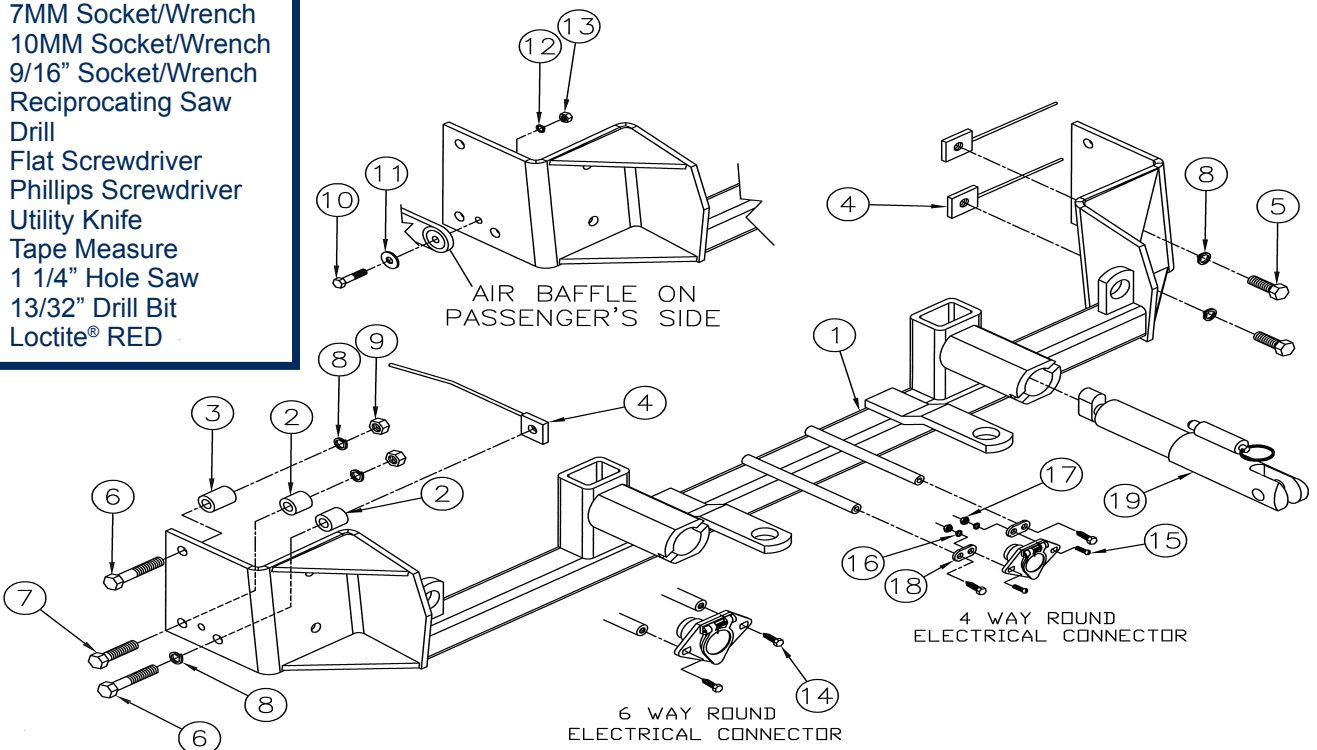

#### Important:

Use only genuine factory replacement parts on your baseplate. Do **NOT** substitute homemade or non-typical parts. If a bolt is lost or in need of replacement, for your safety and the preservation of your baseplate, be sure to use a replacement bolt of the same grade (In most cases it will be Grade 5, please reference the parts list above). Replacement parts may be ordered through your nearest Blue Ox® Dealer or Distributor.

## BX1687

# 2008 Chevy Aveo (Includes Foglights) Installation Instructions

**Vehicle Weight:** Motorhome mount tow bars are recommended for use with this baseplate. Due to the design of the removable tabs, the RangeFinderII, Adventurer, and Ambassador tow bars can not be used. The Acclaim tow bar may be used, but will not fold and store on the front of the vehicle. Adapters, except the BX8833 and BX88151, can not be used with this baseplate.

**Installation Notes:** The grille, headlight assembly, blinker assembly, fascia and air baffle are removed and reinstalled during installation of the baseplate. Drilling is required. Trimming is required.

The dimensional variations between otherwise identical vehicles can be considerable. While the baseplate was designed for easy installation, it may be necessary to tailor the baseplate slightly to compensate for auto manufacturer's tolerances. These minor adjustments may include filing a hole slightly, bending electrical rods and/ or bending end plates.

The BX8869 Bulb & Socket Wiring Kit is recommended for this vehicle.



Possible location for Bulb and Socket Wiring Kit (BX8869).

## Installation Instructions:

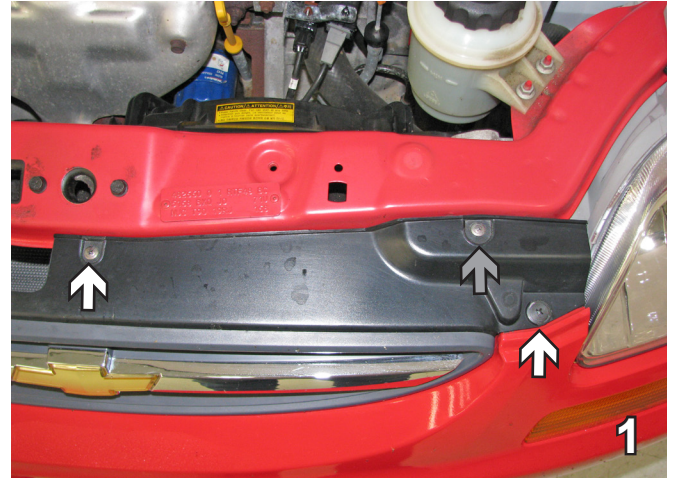

1. Remove three phillips screws (white arrows) and two plastic push pins (gray arrow) from black plastic grill cover on top side of fascia, lift cover and set aside to be reinstalled later.

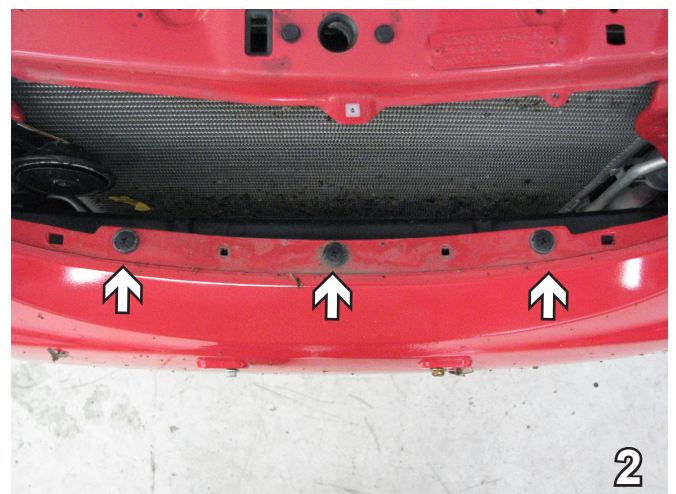

2. Lift the grille out. Just between headlight assemblies, on top edge of fascia, are three push pins to remove. Set the pins aside to be reinstalled later.

**Do not use the towed vehicle for storing luggage, equipment, etc. This may cause you to exceed the towing capacity of the tow bar, baseplate, and its accessories.**



## BX1687

# 2008 Chevy Aveo (Includes Foglights) Installation Instructions

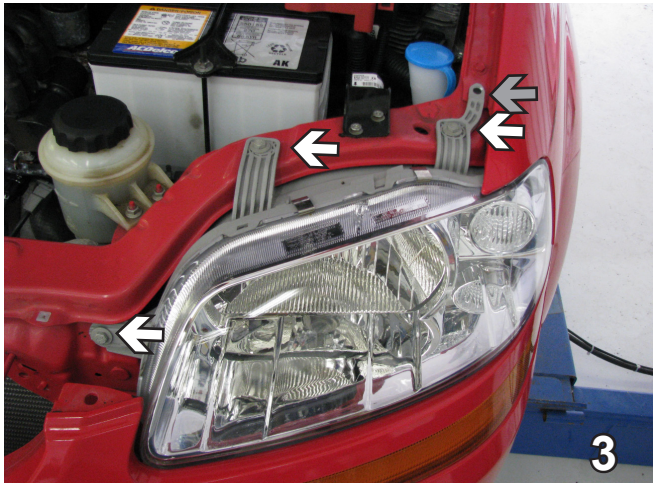

3. Using a 10MM socket, remove three screws (white arrows) and one push pin (gray arrow) from headlight assembly. Pull forward, unplug electrical and set push pins aside. Do this to both sides of the vehicle.



4. Using a 7MM socket, remove the metric bolt from the blinker assembly just below headlight assembly. Do this to both sides of the vehicle. Set bolts aside to be reinstalled later.

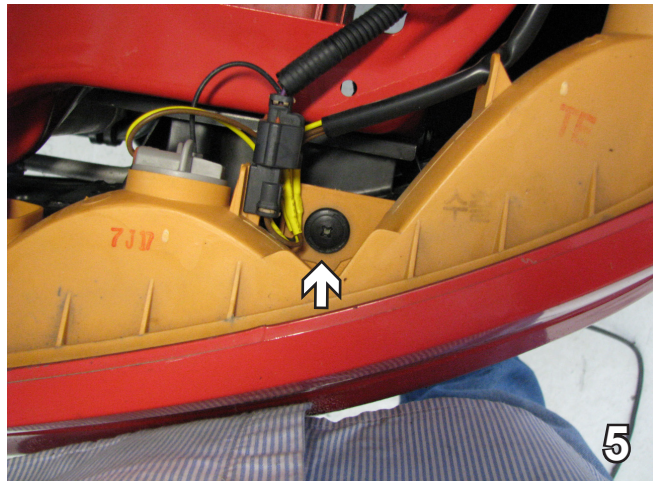

5. Remove one push pin just below headlight assembly, both sides, unplug electrical connections and set aside. Do this to both sides of the vehicle.
7. Just below blinker assembly are two push pins to remove, both sides.

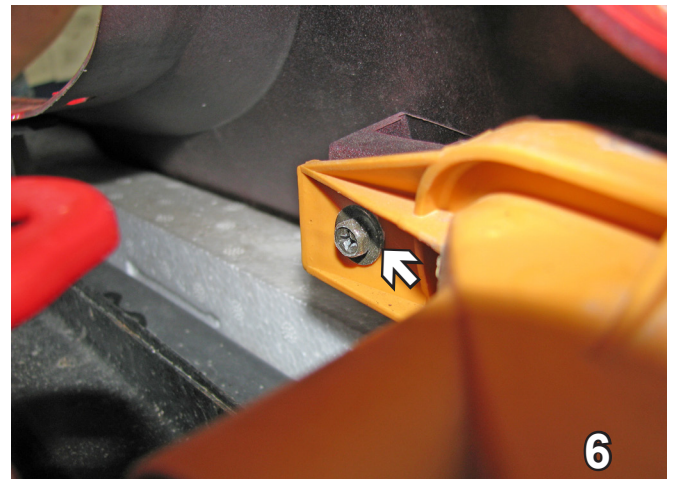

6. Using a 7MM socket, remove the metric bolt from the other side of the blinker assembly. Do this on both sides. Set blinker and bolts aside to be reinstalled later.





**BX1687**  
**2008 Chevy Aveo (Includes Foglights)**  
**Installation Instructions**



8. Just forward of front tires, in wheel well, are two metric bolts to remove on fascia corner with the 7MM socket, both sides.



9. Using the phillips screw driver, remove three screws from the upper opening of fascia.



10. Just forward of front tire underneath on driver side, is one metric bolt to remove using the 7MM socket. Do this on both sides.

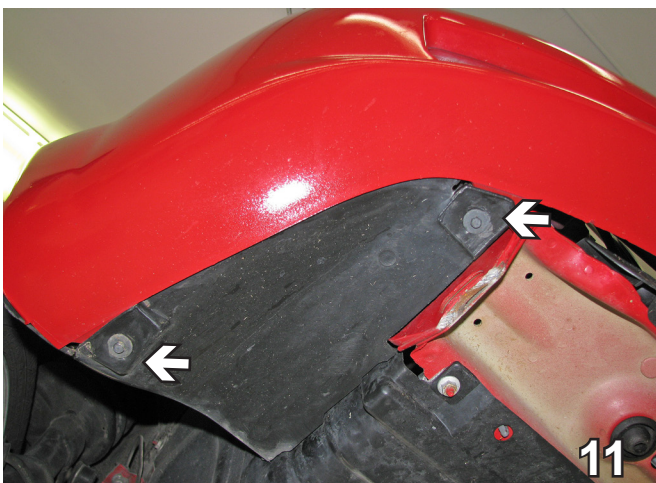

11. Just forward of front tire, on passenger side, are two metric bolts to remove using the 7MM socket. Pull the fascia forward and set aside carefully.



**BX1687**  
**2008 Chevy Aveo (Includes Foglights)**  
**Installation Instructions**

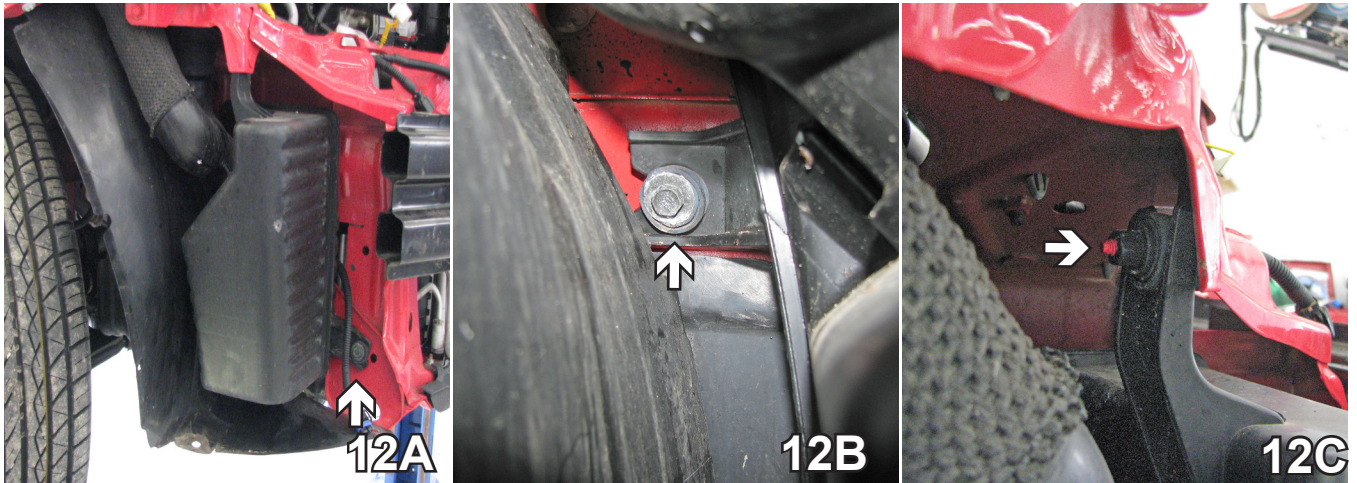

12. On the passenger side, remove the two metric bolts and one metric hex nut, disconnect tube and set air baffle aside.

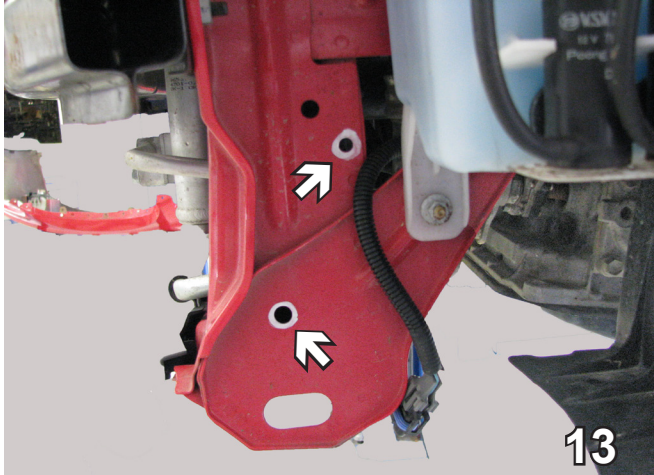

13. Locate these two existing holes on lower frame extension, just above tie down bracket and drill out with the 13.32" drill bit, both sides.

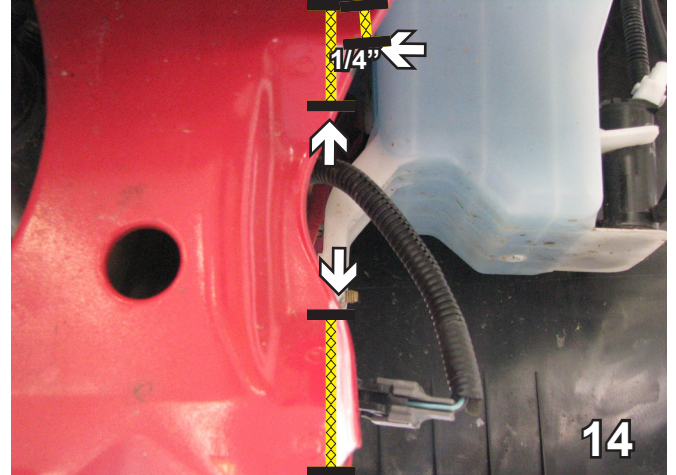

14. Cut 1/4" inch across where the frame starts to bow and straight down. Continuing on down trim off 1/4". Be sure not to cut into the spot welds. Do this on both sides.



## BX1687

# 2008 Chevy Aveo (Includes Foglights) Installation Instructions

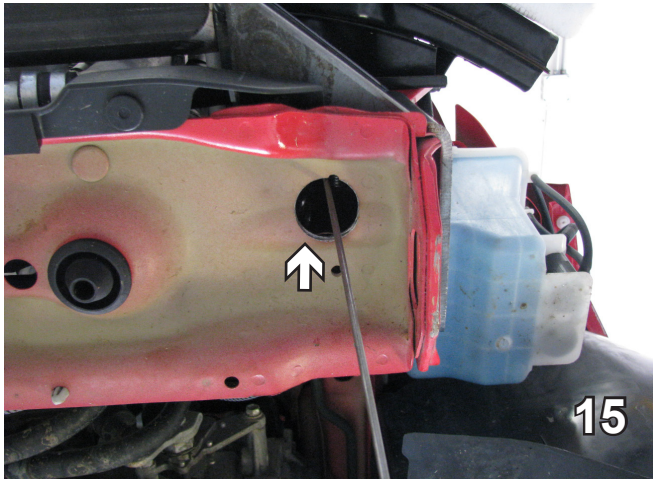

15. Using the 1 1/2" hole saw, cut a hole into the bottom of frame extension just below tie down bracket, both sides.

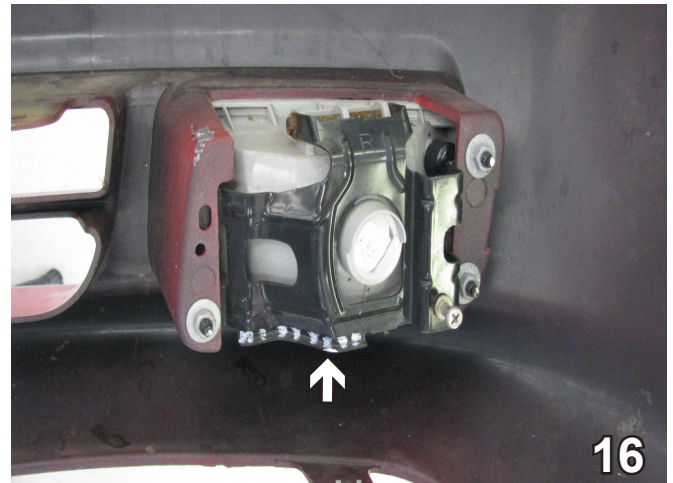

16. On the back side of the fascia, cut the 1/4" lower lip off of the running lights. Then cut 1" off 1/2" down from the bend, both sides.

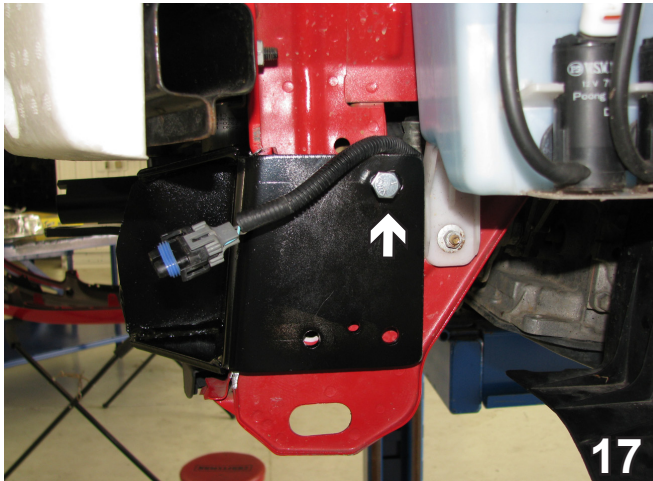

17. Align the baseplate with the upper existing hole on the side of the frame extension. Insert 3/8-16 x 2" hex bolt through baseplate's top hole and 3/4" spacer into upper existing hole. Install 3/8" lock washer and hex nut on the back side of webbing, tighten, both sides. Use loctite on bolts. Be sure the baseplate is level with respect to the vehicle frame.

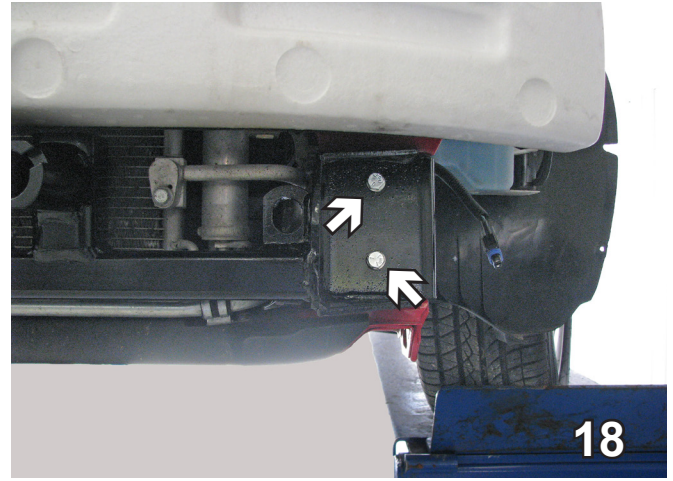

18. Using the baseplate as a template, drill the two holes on the front of baseplate with the 13/32" drill bit. Insert the 3/8-16 nut plates into the 1 1/2" drilled hole in lower frame extension to tighten with 3/8-16 x 1 1/4" bolts and 3/8" lock washers, both sides. Use loctite on bolts.

**BE SURE TO USE LOCTITE® RED ON ALL BOLTS BEFORE TIGHTENING. TIGHTEN ALL BOLTS ACCORDING TO THE TORQUE CHART ON THE FRONT PAGE OF THESE INSTRUCTIONS OR ON PAGE 3 OF THE BASEPLATE TOWING GENERAL INSTRUCTIONS.**

## BX1687

# 2008 Chevy Aveo (Includes Foglights) Installation Instructions

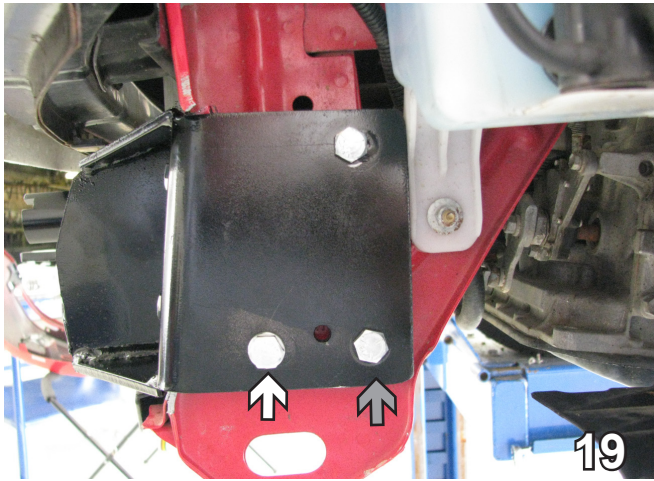

19. Drill out the two bottom holes on the side. Insert 3/8-16 x 2" hex bolt and 3/8" lock washer through the front side hole (white arrow), through 1/2" spacer into 3/8-16 nut plate. Insert 3/8-16 x 1 1/2" hex bolt into back side hole (gray arrow), through 1/2" spacer tighten with 3/8" lock washer and hex nut, both sides. Be sure and use loctite on all bolts.

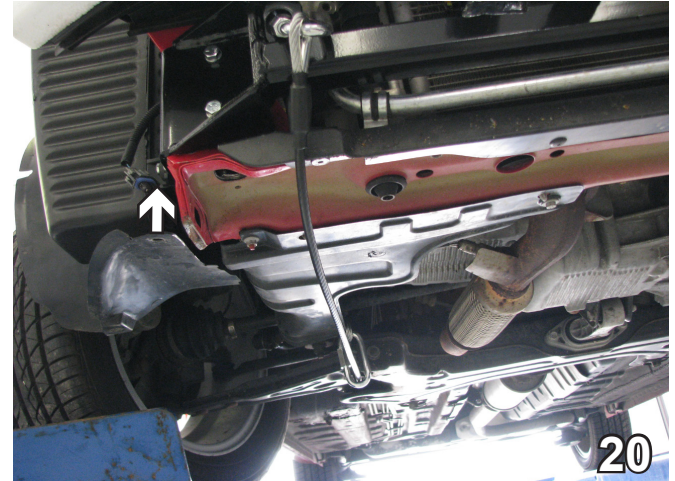

20. Reinstall air baffle on passenger side using the 1/4-20 x 2 1/2" hex bolt, 1/4" flat washer, 1/4" lock washer and 1/4-20 hex nut on front bolt location as shown on page 2. Use the existing hex nut and hex bolt for the back bolt locations. Be sure the connecting tube is properly installed.

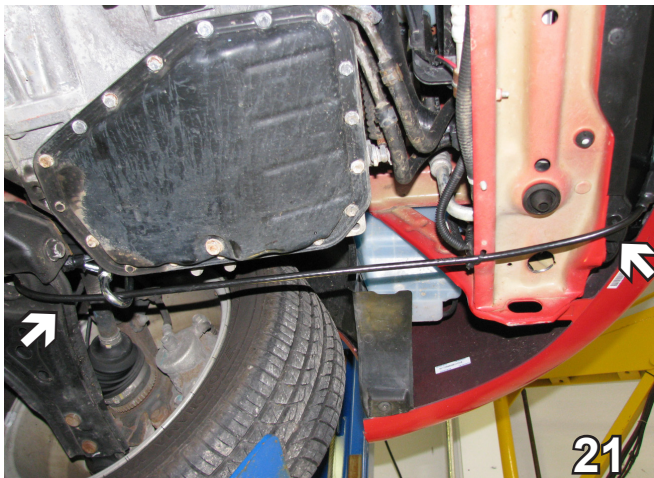

21. Attach the permanent baseplate safety cables to the provided convenience link on the baseplate. The photo above shows the recommended installation of the cables to frame of vehicle. Additional options may interfere with suggested mounting; in this case secure the cables to a solid piece of the frame as described in the instructions included with the permanent baseplate safety cables. Be sure the safety cables do not rub against any hoses or moving parts.

Be sure that **ALL** electrical connections are plugged in properly and functioning **BEFORE** installing the fascia.

22. Reinstall the blinker assembly, headlight assembly, fascia and grille. Be sure all electrical components are plugged in properly. Install the tow bar and safety cables according to the instructions provided in their packages. When demonstrating this to the customer, be sure to include all the contents and packages.

Do **NOT** substitute other devices if the tow bar pins and clips are misplaced.



## BX1687

# 2008 Chevy Aveo (Includes Foglights) Installation Instructions

**DEALER or INSTALLER:**  
Be certain the user receives the  
instruction sheets for their products.



**Shown without removable tabs installed.**



**Shown with removable tabs installed.**

If the baseplate is in an accident, it must be replaced. DO NOT use it again! An accident can cause unseen damage and using it again could result in more damage or serious injury. DO NOT use the baseplate if it is damaged or missing parts.

## CUSTOMER SERVICE COMMITMENT

Blue Ox is committed to providing you with exceptional customer care throughout your lifetime with our products. Our team is here to assist you with any questions you may have regarding the performance of your product. Simply call (402) 385-3051 and you can speak with our customer care team.

Additionally, please visit our website to see which rallies our Destination America team will be attending. For a nominal fee, our service technician will service your towing system to ensure it's in proper working condition. Also, as a commitment to our customers, should you visit our factory, you can stay at our full service Blue Ox campground at no charge along with enjoying a factory tour.

Again, thank you for being our customer and for the confidence you have shown in the performance of our products. It is because of customers like you we enjoy the success we have today.



© 2011 Blue Ox  
One Mill Road, Industrial Park  
Pender, Nebraska 68047  
Phone: (402) 385-3051 • Fax: (402) 385-3360  
[www.blueox.com](http://www.blueox.com)