



BX1692

2006-11 Chevy HHR (No SS or Turbo)

Installation Instructions

Serial Number

Please read BOTH these Installation Instructions and the General Instructions before attempting to install or operate this equipment.

- Blue Ox® towing products and accessories are intended to be installed by Blue Ox® Dealers who are familiar with our products and have the equipment and knowledge to do “fit work”. When necessary Blue Ox® Dealers can be found at www.blueox.com or by contacting our Customer Care Department at (402) 385-3051.
- Many Blue Ox® Baseplates are designed to use existing holes and hardware to mount the baseplate to the towed vehicle. Even though bolts are there, do not assume they are adequate for baseplate mounting. Always use hardware supplied in the hardware kit or existing hardware specified in the Baseplate Towing Installation Instructions.

Attachment Tab Height: 13.5”

Attachment Tab Width: 22”

Bolt Torque Specifications
Torque in Foot-Pounds for Metric Bolts

Bolt Size	Grade 8.8	Grade 10.9
6MM	6	8
8MM	16	22
10MM	31	40
12MM	54	70
14MM	89	117

Confirm the towability and pre-towing procedures for your vehicle with the owner’s manual or contact the vehicle’s manufacturer for specific towing procedures.

Bolt Torque Specifications
Torque in Foot-Pounds for Inch Bolts

Bolt Size	Grade 5	Grade 8
1/4”	10	14
5/16”	19	29
3/8”	33	47
7/16”	54	78
1/2”	78	119
5/8”	154	230



! WARNING

Failure to read and follow these instructions could result in separation of the towed vehicle from the tow bar, causing property damage, loss of towed vehicle, personal injury or death.



BX1692

2006-11 Chevy HHR (No SS or Turbo)

Installation Instructions

Parts List

Ref. No.	Qty.	Part #	Description
1	1	61-6740	Weldment, Baseplate, BX1692
2	1	101-7527	Spacer Plate, DS, BX1692
3	1	101-7528	Spacer Plate, PS, BX1692
4	10	61-5208	Weldment, 3/8"-14 Nut Plate, Grd. 5, ZP
5	10	201-0440	3/8"-16 x 1 1/2" Hex Bolt, Grd. 5, ZP
6	10	203-0010	3/8" Lock Washer, ZP
7	2	201-0979	#12-14 x 1" Self Drilling Screw, ZP
8	2	201-0192	#10-32 x 1/2" Slot, Rd. Hd. Screw
9	2	203-0054	#10 Lock Washer
10	2	202-0047	#10-32 Hex Nut
11	2	101-5822	Adapter, 4 Way Connector
12	2	62-3468	Attachment, Assembly, SF/SB (R)
13	1	102-7056	Coolant Bracket, BX1689
14	2	201-0050	1/4-20 X 3/4 Hex Bolt Grd.5, ZP
15	2	202-0102	1/4-20 Hex Nyl Nut, ZP
	2	226-0046	Baseplate Safety Cable, 36" CL III (Not SH)
	2	229-0359	Quicklink, 3/8, ZP (Not Shown)
	2	290-0437	Cap Plug, Black (Not Shown)

Tools Required

- 7MM Socket
- 13MM Socket
- 9/16" Socket/Wrench
- Large Vise Grip
- Drill
- Utility Knife
- 13/32" Drill Bit
- Loctite® RED

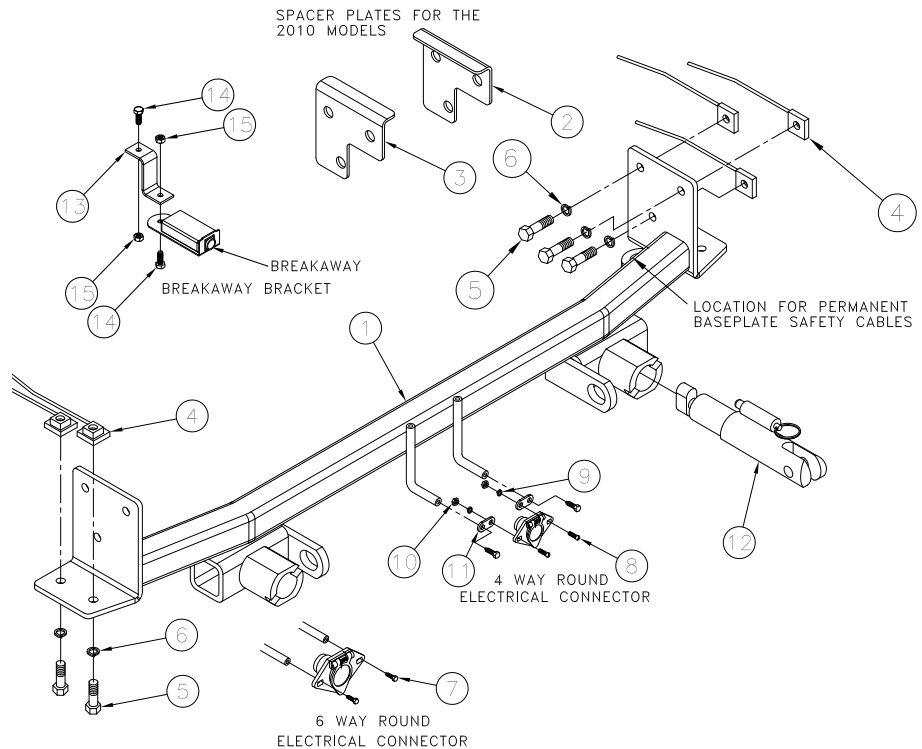

Important:

Use only genuine factory replacement parts on your baseplate. Do **NOT** substitute homemade or non-typical parts. If a bolt is lost or in need of replacement, for your safety and the preservation of your baseplate, be sure to use a replacement bolt of the same grade (In most cases it will be Grade 5, please reference the parts list above). Replacement parts may be ordered through your nearest Blue Ox® Dealer or Distributor. Failing to follow and/or altering these installation instructions in either installation or required equipment will void the manufacturer's warranty. Towing behind a non-motorized vehicle will void the warranty.



BX1692

2006-11 Chevy HHR (No SS or Turbo)

Installation Instructions

Attachment Tabs:

Motorhome mount tow bars are recommended for use with this baseplate. Due to the design of the removable tabs, the RangeFinder II and Ambassador tow bars can not be used. Adapters, except the BX8833 and BX88151, can not be used with this baseplate.

Instructions:

The front fascia, and metal bumper are removed for the baseplate installation. Drilling is required. Trimming of the fascia is required.

The dimensional variations between otherwise identical vehicles can be considerable. While the baseplate was designed for easy installation, it may be necessary to tailor the baseplate slightly to compensate for auto manufacturer's tolerances. These minor adjustments may include filing a hole slightly, bending electrical rods or bending end plates.

The BX8848 4-Diode Wiring Kit is recommended for this vehicle.

Handling of some cosmetic parts when installing this product may require the use of protective covers, rags, specialty tools, etc. to prevent damage.



1. Using the 7MM Socket remove two 7MM bolts from the front fascia near the headlight housing. This will need to be done to both sides of the vehicle, the passenger's side is shown. Set bolts aside to be reinstalled later.



2. Just forward of the front tire, remove one 7MM bolt with the 7MM Socket (see grey arrow) and remove two push pins (see white arrows). This is done on both sides of the vehicle, the driver's side is shown. Set all aside to be reinstalled later.



BX1692

2006-11 Chevy HHR (No SS or Turbo)

Installation Instructions

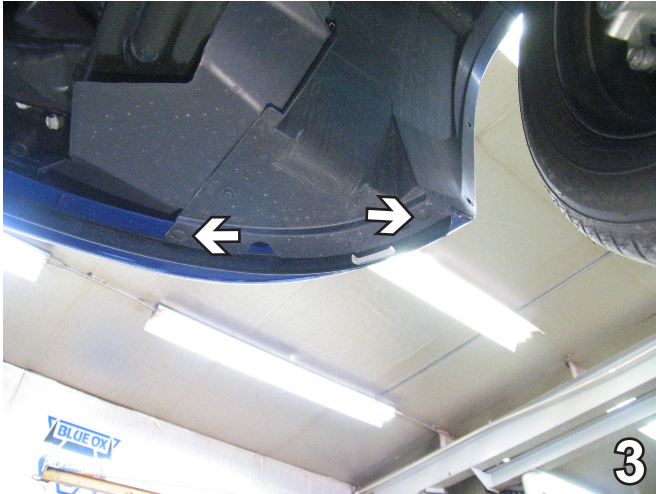

3. Just forward of the front tires, on the under side of the front fascia, remove two push pins. This is done on both sides of the vehicle, the passenger's side is shown. Set the push pins aside to be reinstalled later. Pull fascia forward and carefully set aside to be reinstalled later.

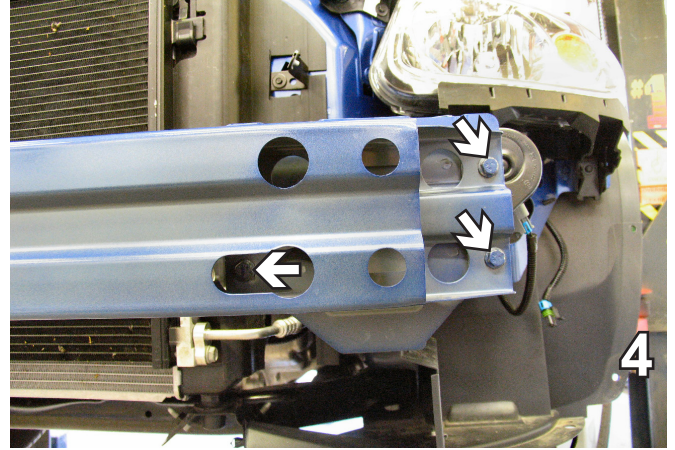

4. Remove three metric bolts from the metal bumper using a 13MM Socket. This will need to be done on both sides of the vehicle, the driver's side is shown. Set bolts aside to be reinstalled later.

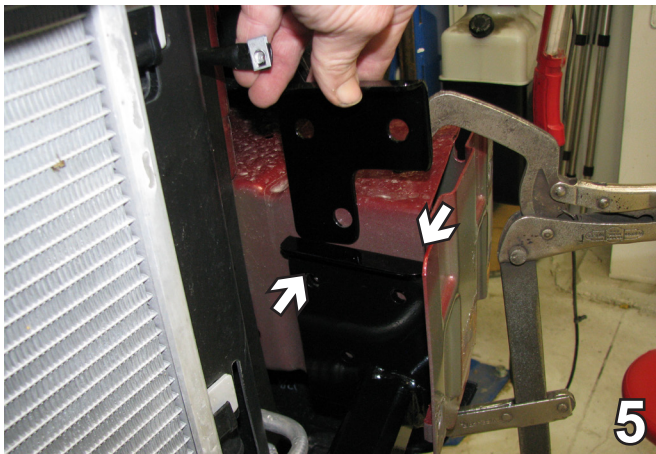

5. From the bottom of the vehicle, slide the baseplate up inside the frame rail until the bottom end plates are flush with the bottom of the frame rail, center and clamp. Tap the proper plate in behind the baseplate on each side.

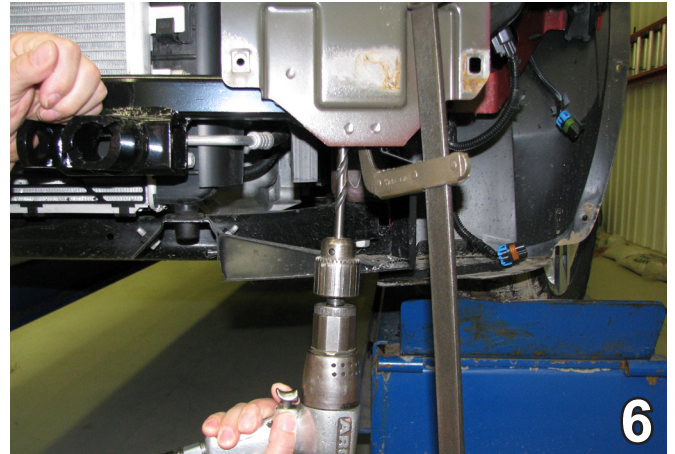

6. Using the baseplate as a template, drill two holes underneath with a 13/32" drill bit. Do this to both sides of the vehicle.

When using power drills be aware of the dangers of torque and drill bit length.



BX1692

2006-11 Chevy HHR (No SS or Turbo)

Installation Instructions

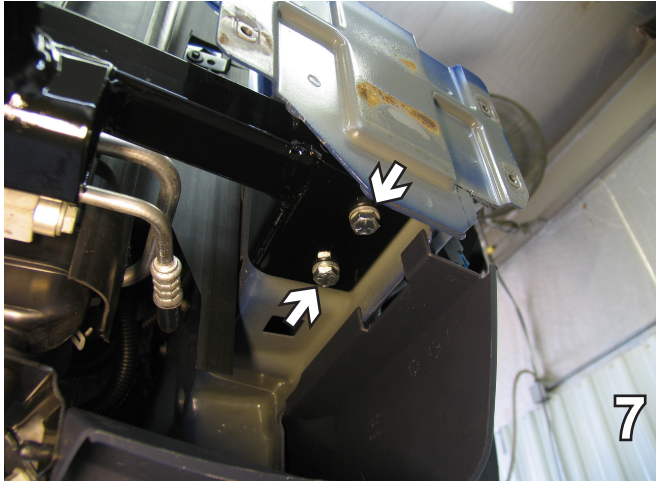

7. Put the nut plates in from the top of the frame just behind the bumper bracket. Install the 3/8-16 x 1 1/2" Hex Bolts and 3/8" Lock Washers. Cut the excess wire from the nut plates. This is done on both sides of the vehicle, the driver's side is shown.

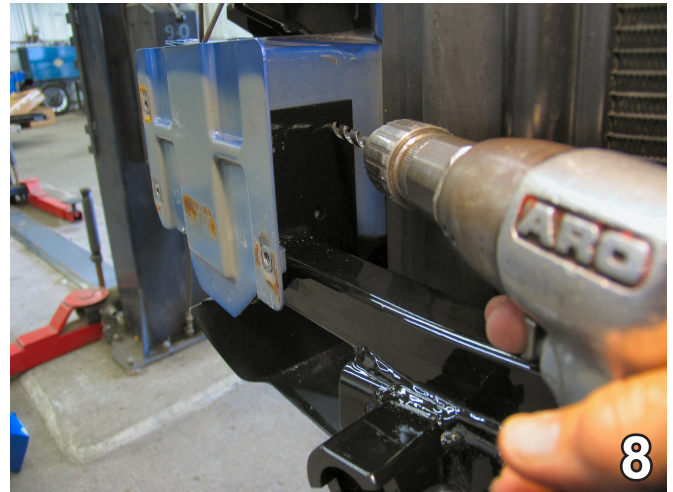

8. Using the baseplate as a template, drill the two front holes in the end plates with the 13/32" drill bit. To prevent drilling into the radiator, place something between the drill and the radiator and drill the back hole at an angle. This is done on both sides of the vehicle, the passenger's side is shown.

BE SURE TO USE LOCTITE® RED ON ALL BOLTS BEFORE TIGHTENING. TIGHTEN ALL BOLTS ACCORDING TO THE TORQUE CHART ON THE FRONT PAGE OF THESE INSTRUCTIONS OR ON PAGE 3 OF THE BASEPLATE GENERAL TOWING INSTRUCTIONS.



9. Insert the three 3/8-16 nut plates into the top of the frame rail and install the three 3/8-16 x 1 1/2" hex bolts and 3/8 Lock Washers. Cut the excess wire from the nut plates once they are installed. This is done on both sides of the vehicle, the driver's side is shown.



10. Attach the permanent baseplate safety cables to the provided convenience link on the baseplate (see grey arrow). The photo above shows the recommended installation of the cables to frame of vehicle (see white arrow). Additional options may interfere with suggested mounting; in this case secure the cables to a solid piece of the frame as described in the instructions included with the permanent baseplate safety cables. Be sure the safety cables do not rub against any hoses or moving parts. Do this to both sides of the vehicle.



BX1692

2006-11 Chevy HHR (No SS or Turbo)

Installation Instructions



11. To install breakaway bracket, drill into the bottom of the bumper, centered between the electrical plug and the convenient link.

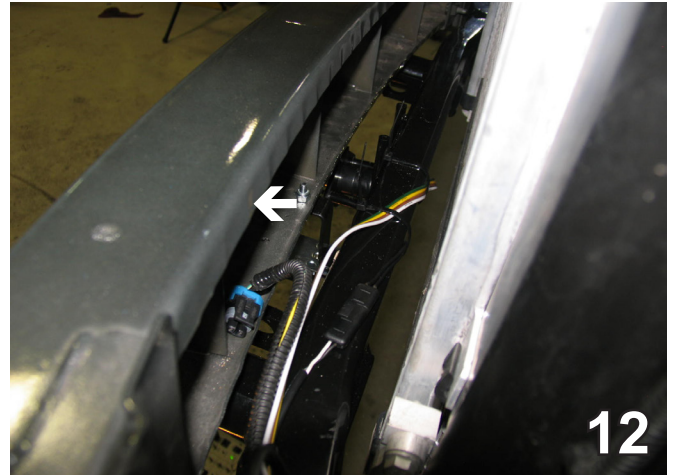

12. Attach the bracket to the bumper with 1/4-20 x 3/4" bolt and 1/4-20 nut. Fasten the breakaway to the bottom of the bracket also with 1/4-20 x 3/4" bolt and 1/4-20 nut.



13. On the back side of the fascia, use a utility knife to trim 3/4"-1" from the outside edge of the opening to allow the attachment tabs to come through. Some models may not require cutting. Try to put fascia on and check to see if trimming is necessary.

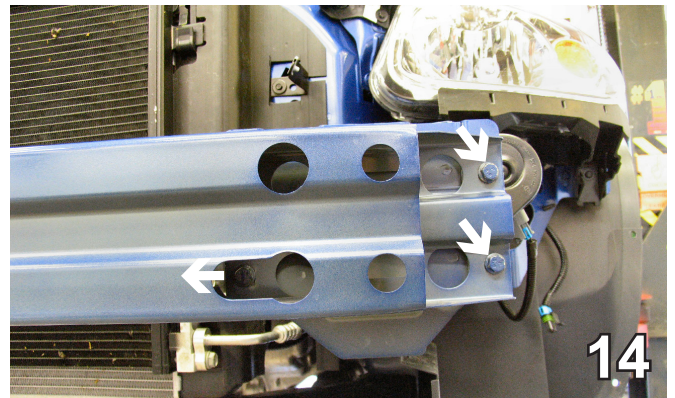

14. Reinstall the front metal bumper. Replace three metric bolts using the 13MM Socket. Make sure that you reinstall ALL bolts (3 bolts on each side).

15. Reinstall front fascia according to the instructions on the previous pages (Steps 1-3).

16. Install the tow bar and safety cables according to the instructions when demonstrating this to the customer. Be sure to include all the contents packages of their Blue Ox products.

17. DO NOT substitute other devices if the tow bar pins and clips are misplaced.

Be sure that ALL electrical connections are plugged in properly and functioning BEFORE installing the fascia.



BX1692

2006-11 Chevy HHR
(No SS or Turbo)
Installation Instructions



Shown without removable tabs.

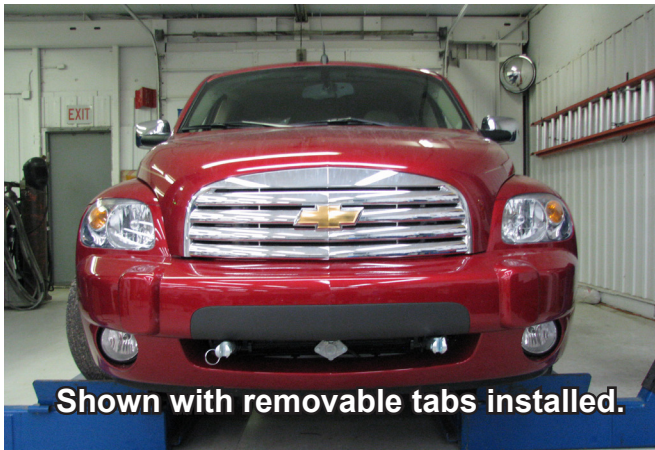

Shown with removable tabs installed.



2011 Shown with removable tabs installed

If the baseplate is in an accident, it must be replaced. **DO NOT** use it again! An accident can cause unseen damage and using it again could result in more damage or serious injury. **DO NOT** use the baseplate if it is damaged or missing parts.

CUSTOMER SERVICE COMMITMENT

Blue Ox is committed to providing you with exceptional customer care throughout your lifetime with our products. Our team is here to assist you with any questions you may have regarding the performance of your product. Simply call (402) 385-2472 and you can speak with our customer care team.

Additionally, please visit our website to see which rallies our Destination America team will be attending. For a nominal fee, our service technician will service your towing system to ensure it's in proper working condition. Also as a commitment to our customers, should you visit our factory you can stay at our full service Blue Ox campground at no charge along with enjoying a factory tour.

Again thank you for being our customer and for the confidence you have shown in the performance of our products. It is because of customers like you we enjoy the success we have today.



© 2010 Blue Ox
One Mill Road, Industrial Park
Pender, Nebraska 68047
Phone: (402) 385-3051
Fax: (402) 385-3360
www.blueox.com
12/2/10