



# BX1709

2002-09 Chevy Trailblazer / GMC Envoy  
2004-07 Buick Rainier  
2003-06 Isuzu Ascender  
2002-04 Oldsmobile Bravada  
Installation Instructions

Attachment Tab Height: 15-1/2"

Attachment Tab Width: 18"

Serial Number

Please read BOTH these Installation Instructions and the General Instructions prior to installing or operating this equipment.

- Blue Ox® towing products and accessories are intended to be installed by Blue Ox® Dealers who are familiar with our products and have the equipment and knowledge necessary to do "fit work". If needed, Blue Ox® Dealers can be found at [www.blueox.com](http://www.blueox.com) or by contacting our Customer Care Department at (402) 385-3051.
- Many Blue Ox® baseplates are designed to use existing holes and hardware to mount the baseplate to the towed vehicle. Even though bolts are there, do not assume they are adequate for baseplate mounting. Always use the hardware supplied in the hardware kit and existing hardware as specified in the installation instructions.

### Bolt Torque Specifications

Torque in Foot-Pounds for Inch Bolts

Bolt Size	Grade 5	Grade 8
1/4"	10	14
5/16"	19	29
3/8"	33	47
7/16"	54	78
1/2"	78	119
5/8"	154	230
3/4"	257	380



If the front of your vehicle looks different than this, please contact us at (402)385-3051.

Reference your vehicle owner's manual for manufacturer's towing specifications.

### Bolt Torque Specifications

Torque in Foot-Pounds for Metric Bolts

Bolt Size	Grade 8.8	Grade 10.9
6MM	6	8
8MM	16	22
10MM	31	40
12MM	54	70
14MM	89	117
16MM	161	230
18MM	222	318



## WARNING

Failure to read and follow these instructions could result in separation of the towed vehicle from the tow bar, causing property damage, loss of towed vehicle, personal injury or death.

BX1709  
2002-09 Chevy Trailblazer / GMC Envoy 2004-07 Buick Rainier  
2003-06 Isuzu Ascender 2002-04 Oldsmobile Bravada  
Installation Instructions

**Instruction Notes:** The fascia, grille, metal bumper and tow hooks are removed and reinstalled for the baseplate installation. Some drilling and trimming is required.

Place all components that are removed on a flat, sturdy surface. All items will be reinstalled unless otherwise noted after the baseplate is installed.

The dimensional variations between otherwise identical vehicles can be considerable. While the baseplate was designed for easy installation, it may be necessary to tailor the baseplate slightly to compensate for vehicle manufacturer's tolerances.

The BX8869 Tail Light Wiring Kit is recommended for this vehicle.

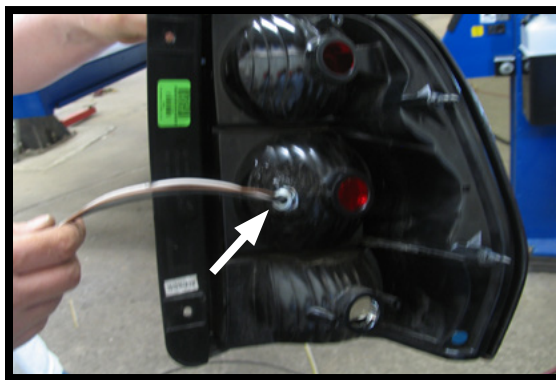

Drill a hole according to the tail  
light wiring kit instructions.

### **NOTICE**

- Handling of some cosmetic parts when installing this product may require the use of protective covers, rags, specialty tools, etc. to prevent damage.
- When using power drills be aware of the dangers of torque and drill bit length.
- When using a reciprocating saw be aware of objects behind the cutting surface.
- Use a good quality paint to spray cut edges of frame to prevent rusting.
- Be sure that **ALL** electrical connections are plugged in and accessories are functioning properly before reinstalling the fascia.
- The baseplate is computer tested to your vehicle's GVWR, exceeding this weight will void the manufacturer's warranty.
- Be sure to use Loctite® Red on all bolts before tightening. Tighten all bolts according to the torque chart provided.
- Dealer or installer be certain the user receives these instruction sheet.
- If the baseplate is in an accident, it must be replaced. **DO NOT** use it again! An accident can cause unseen damage and using it again could result in more damage or serious injury. **DO NOT** use the baseplate if it is damaged or missing parts.

# BX1709

2002-09 Chevy Trailblazer / GMC Envoy 2004-07 Buick Rainier  
 2003-06 Isuzu Ascender 2002-04 Oldsmobile Bravada  
**Installation Instructions**

## Tools Required

Large Vise Grip  
 Utility Knife  
 Torque Wrench  
 Drill  
 Tape Measure  
 Loctite® RED  
 17/32" Drill Bit  
 10MM Socket  
 15MM Socket  
 21MM Socket  
 3/4" Socket  
 15/16" Socket  
 15/16" Wrench

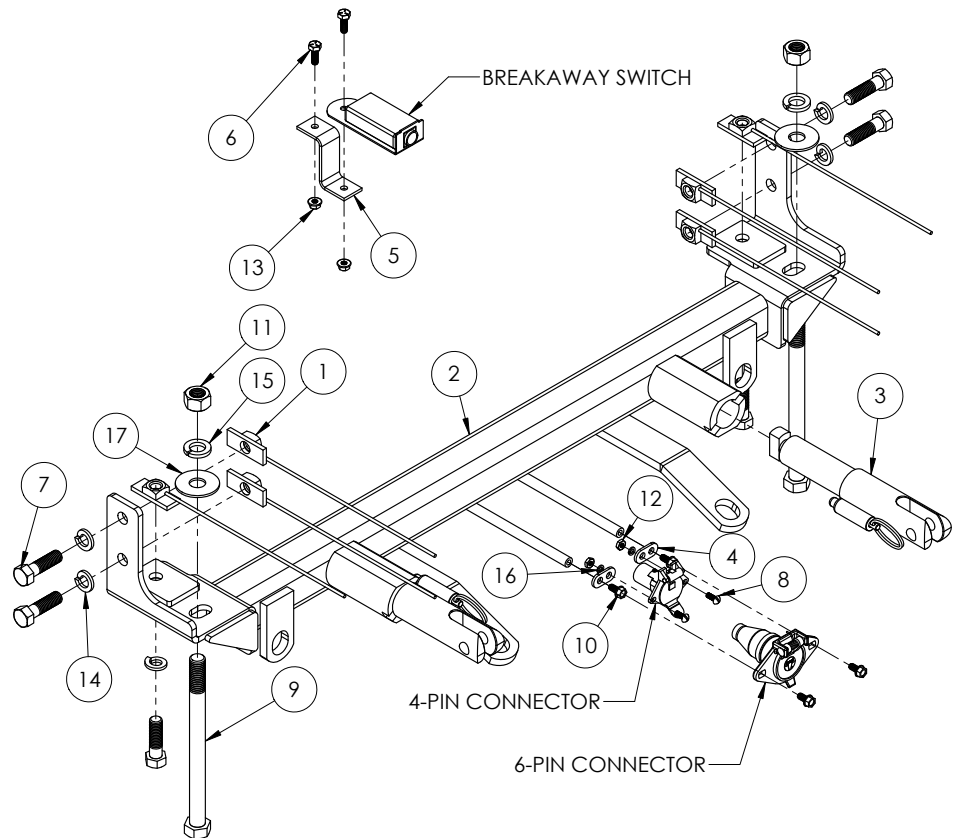

Item No.	Part No.	Description	Qty.
1	61-3799	1/2"-13 Nut Plate w/ 10" Wire	6
2	61-7227	BX1709 Baseplate	1
3	62-3469	Attachment Tab Assembly with Hole	2
4	101-5822	4 Way Connector Adapter	2
5	102-7056	Breakaway Bracket	1
6	201-0050	1/4"-20 x 3/4" Hex Head Bolt, Grade 5, ZP	2
7	201-0068	1/2"-13 x 1-3/4" Hex Head Bolt, Grade 5, ZP	6
8	201-0192	#10-32 1/2" Round Slotted Head Screw	2
9	201-0376	5/8"-11 x 8" Hex Head Bolt, Grade 5, ZP	2
10	201-0979	#12-14 x 1" Self Drilling Screw, ZP	2
11	202-0006	5/8"-11 Hex Nut	2
12	202-0047	#10-32 Hex Nut	2
13	202-0069	1/4"-20 Hex Whiz Nut, ZP	2
14	203-0012	1/2" Lock Washer, ZP	6
15	203-0013	5/8" Lock Washer, ZP	2
16	203-0054	#10 Lock Washer, ZP	2
17	203-0106	5/8" Flat Washer, ZP	2
18	226-0046(not shown)	Class III Safety Cables	2
19	229-0359(not shown)	3/8" Quicklink, ZP	2
20	290-0437(not shown)	Black Cap Plug Receiver	2

## Important:

Use only genuine factory replacement parts on your baseplate. Do **NOT** substitute homemade or non-typical parts. If a bolt is lost or in need of replacement, for your safety and the preservation of your baseplate, be sure to use a replacement bolt of the same grade (In most cases it will be Grade 5, please reference the parts list above). Replacement parts may be ordered through your nearest Blue Ox® Dealer or Distributor. Failing to follow and/or altering these installation instructions in either installation or required equipment will void the manufacturer's warranty. Towing behind a non-motorized vehicle will void the warranty.

## BX1709

### 2002-09 Chevy Trailblazer / GMC Envoy 2004-07 Buick Rainier 2003-06 Isuzu Ascender 2002-04 Oldsmobile Bravada Installation Instructions

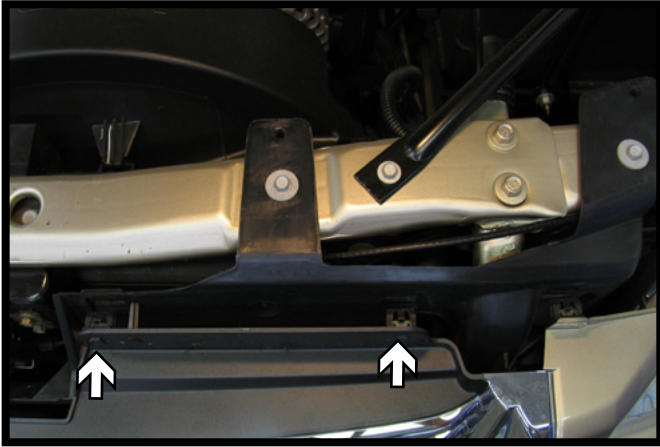

1. Release the four (4) snaps from the top edge of the grille. There are two (2) on each side.

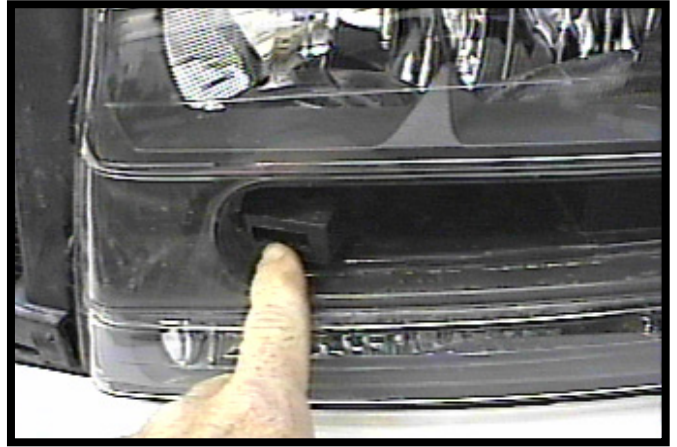

2. **Trailblazer Only:** The grille is also attached towards the middle of the headlight assembly. Pull forward to release the clip. Do this on both sides of the vehicle and set the grille aside.

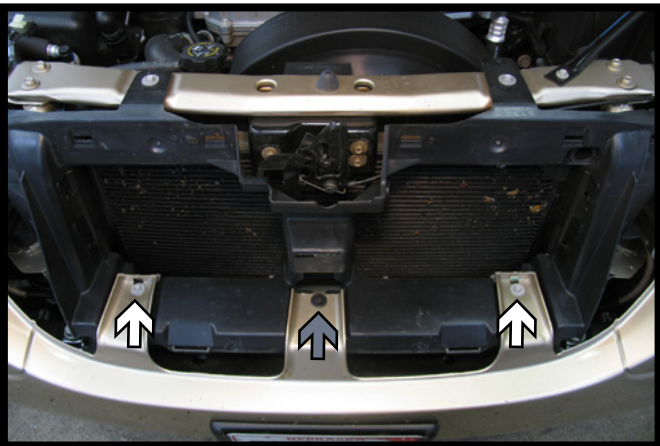

3. Using a 10MM socket, remove the two (2) screws from the top edge of the fascia (white). Then remove the push pin (gray).



4. Remove the push pin from the underside of the fascia in front of the tire. Do this to both sides of the vehicle.

BX1709  
2002-09 Chevy Trailblazer / GMC Envoy 2004-07 Buick Rainier  
2003-06 Isuzu Ascender 2002-04 Oldsmobile Bravada  
Installation Instructions

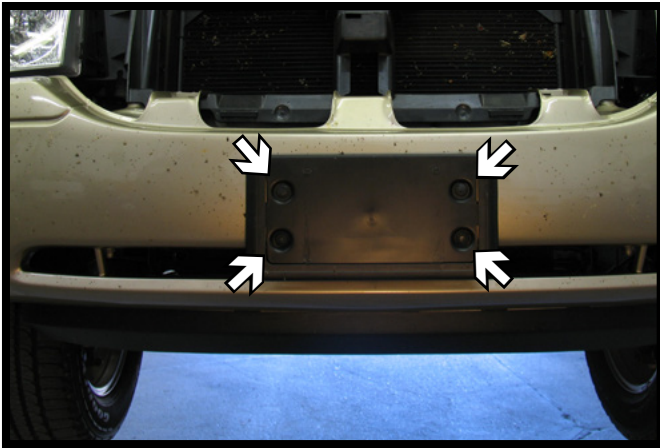

5. If equipped, remove the four (4) push pins from the license plate bracket and set aside.

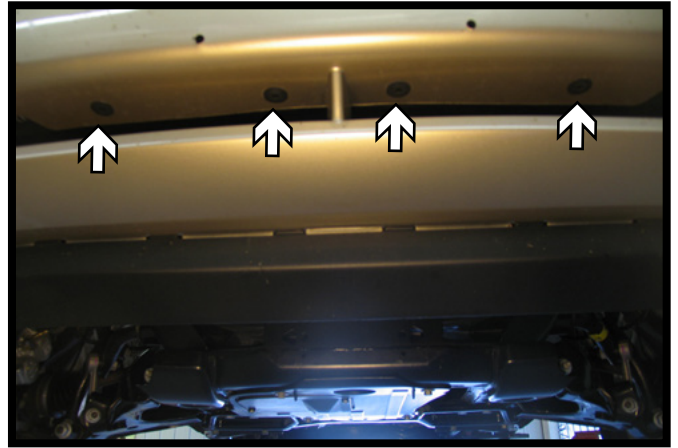

6. On the underside of the lower fascia opening, remove the four (4) push pins. Remove the fascia from the vehicle.

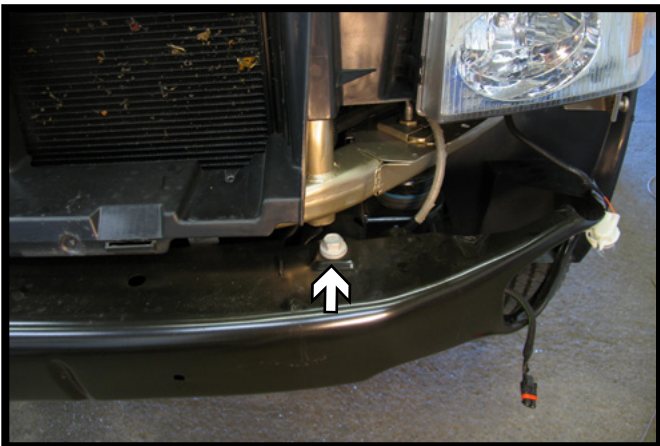

7. Using a 21MM socket, remove the two (2) bolts from the top of the bumper. There is one (1) on each side. Remove the bumper from the vehicle.



8. If equipped, using a 15MM socket, remove the tow hooks. The tow hooks will not be reinstalled.

## BX1709

### 2002-09 Chevy Trailblazer / GMC Envoy 2004-07 Buick Rainier 2003-06 Isuzu Ascender 2002-04 Oldsmobile Bravada Installation Instructions

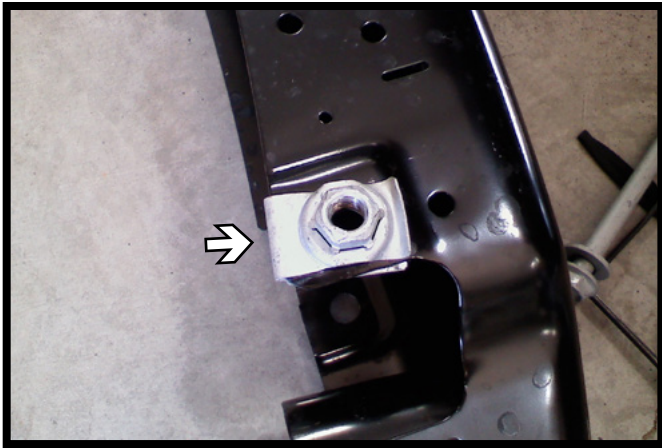

9. Remove the factory nut bracket from the bumper. Do this on both sides of the bumper.



10. Trim the shrouding on both sides of the vehicle as shown.

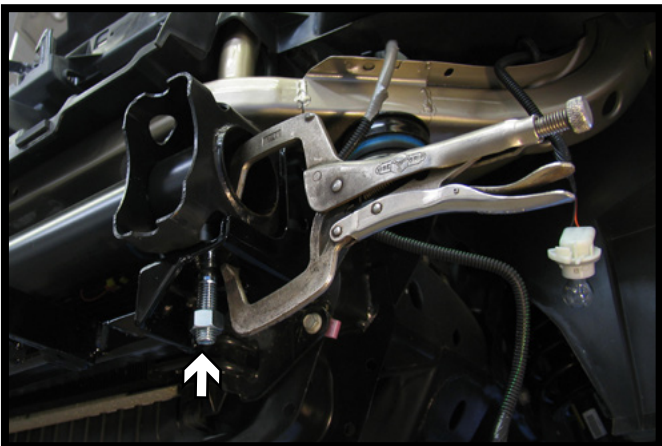

11. Position the baseplate onto the vehicle. Install the 5/8"-11 x 8" bolt thru the frame and baseplate to position it on the frame and clamp in place.

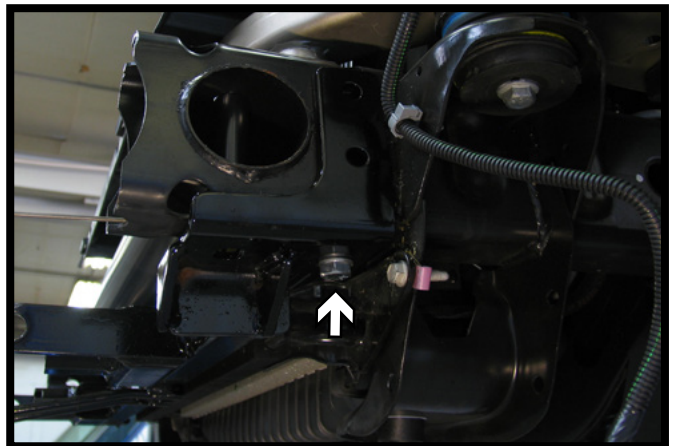

12. Using a 17/32" drill bit, drill the underside baseplate hole thru the frame. Install a 1/2"-13 x 1-3/4" bolt and a 1/2" lock washer into the hole with a 1/2" nut plate on the inside of the frame. Fully tighten the hardware. Do this on both sides of the vehicle.

## BX1709

### 2002-09 Chevy Trailblazer / GMC Envoy 2004-07 Buick Rainier 2003-06 Isuzu Ascender 2002-04 Oldsmobile Bravada Installation Instructions

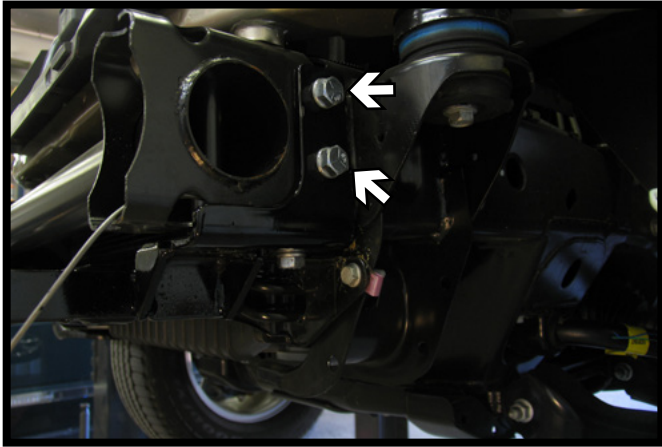

13. Using a 17/32" drill bit, drill the two (2) side baseplate holes thru the frame. Install a 1/2"-13 x 1-3/4" bolts and a 1/2" lock washers into the holes with a 1/2" nut plates on the inside of the frame. Fully tighten the hardware. Do this on both sides of the vehicle.

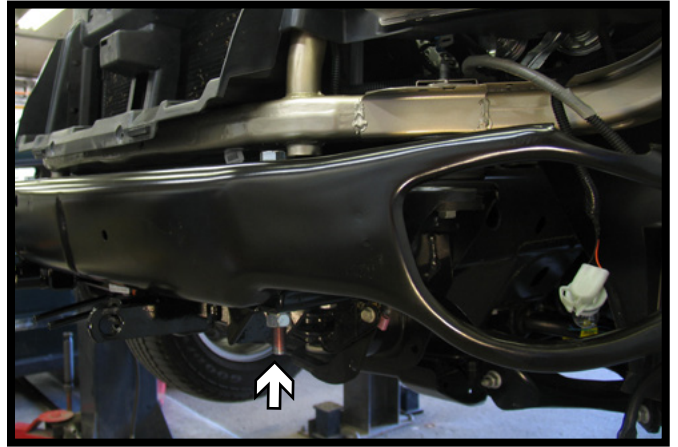

14. Reinstall the bumper using the supplied 5/8"-11 x 8" bolts, 5/8" flat & lock washers and 5/8"-11 hex nuts.



15. Attach the permanent baseplate safety cables to the provided convenience link on the baseplate. The photo above shows the recommended installation of the cables to frame of vehicle. Additional options may interfere with suggested mounting; in this case, secure the cables to a solid piece of the frame as described in the instructions included with the permanent baseplate safety cables. Be sure the safety cables do not rub against any hoses or moving parts. Do this on **BOTH** sides of the vehicle.

## BX1709

2002-09 Chevy Trailblazer / GMC Envoy 2004-07 Buick Rainier  
2003-06 Isuzu Ascender 2002-04 Oldsmobile Bravada  
Installation Instructions

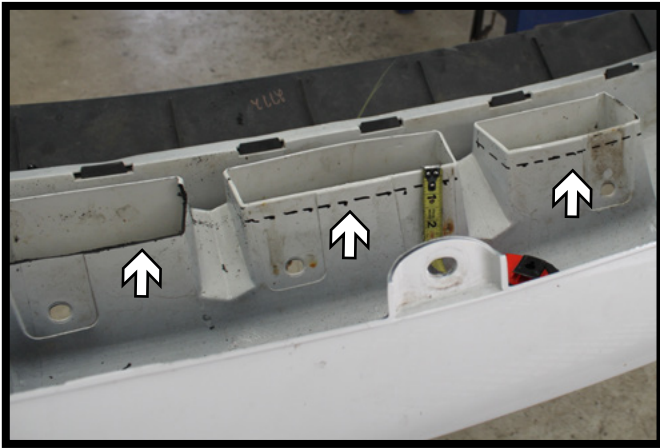

16. **Trailblazer Only:** On the backside of the fascia, trim the middle three (3) openings approximately as shown for baseplate clearance.



17. Reinstall the fascia, license plate bracket and grille.

### CUSTOMER SERVICE COMMITMENT

Blue Ox® is committed to providing you with exceptional customer care throughout your lifetime with our products. Our team is here to assist you with any questions you may have regarding the performance of your product. Simply call (402) 385-3051 and you can speak with our customer care team.

Additionally, please visit our website to see which rallies our Destination America team will be attending. For a nominal fee, our service technician will service your towing system to ensure it's in proper working condition. Also, as a commitment to our customers, should you visit our factory, you can stay at our full service Blue Ox® campground at no charge along with enjoying a factory tour.

Again, thank you for being our customer and for the confidence you have shown in the performance of our products. It is because of customers like you we enjoy the success we have today.

© 2013 Blue Ox  
One Mill Road, Industrial Park  
Pender, Nebraska 68047  
Phone: (402) 385-3051  
Fax: (402) 385-3360  
[www.blueox.com](http://www.blueox.com)