



BX1836

2005-15 Nissan Xterra Installation Instructions

Attachment Tab Height: 16"

Attachment Tab Width: 24"

Serial Number

Please read BOTH these Installation Instructions and the General Instructions prior to installing or operating this equipment.

- Blue Ox® towing products and accessories are intended to be installed by Blue Ox® Dealers who are familiar with our products and have the equipment and knowledge necessary to do "fit work". If needed, Blue Ox® Dealers can be found at www.blueox.com or by contacting our Customer Care Department at (402) 385-3051.
- Many Blue Ox® baseplates are designed to use existing holes and hardware to mount the baseplate to the towed vehicle. Even though bolts are there, do not assume they are adequate for baseplate mounting. Always use the hardware supplied in the hardware kit and existing hardware as specified in the installation instructions.



If the front of your vehicle looks different than this, please contact us at (402)385-3051.

Reference your vehicle owner's manual for manufacturer's towing specifications.

Bolt Torque Specifications

Torque in Foot-Pounds for Inch Bolts

Bolt Size	Grade 5	Grade 8
1/4"	10	14
5/16"	19	29
3/8"	33	47
7/16"	54	78
1/2"	78	119
5/8"	154	230
3/4"	257	380

Bolt Torque Specifications

Torque in Foot-Pounds for Metric Bolts

Bolt Size	Grade 8.8	Grade 10.9
6MM	6	8
8MM	16	22
10MM	31	40
12MM	54	70
14MM	89	117
16MM	161	230
18MM	222	318



WARNING

Failure to read and follow these instructions could result in separation of the towed vehicle from the tow bar, causing property damage, loss of towed vehicle, personal injury or death.

BX1836
2005-15 Nissan Xterra
Installation Instructions

Instruction Notes: The grille, fascia and bumper are removed and reinstalled for the baseplate installation. Some drilling and trimming is required.

Place all components that are removed on a flat, sturdy surface. All items will be reinstalled unless otherwise noted after the baseplate is installed.

The dimensional variations between otherwise identical vehicles can be considerable. While the baseplate was designed for easy installation, it may be necessary to tailor the baseplate slightly to compensate for vehicle manufacturer's tolerances.

The BX8869 Tail Light Wiring Kit is recommended for this vehicle.

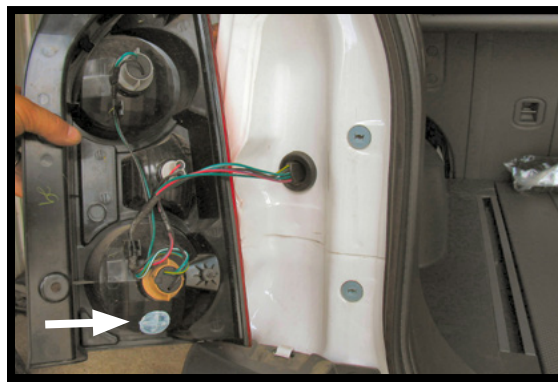

Drill a hole according to the tail light wiring kit instructions.

NOTICE

- Handling of some cosmetic parts when installing this product may require the use of protective covers, rags, specialty tools, etc. to prevent damage.
- When using power drills be aware of the dangers of torque and drill bit length.
- When using a reciprocating saw be aware of objects behind the cutting surface.
- Use a good quality paint to spray cut edges of frame to prevent rusting.
- Be sure that **ALL** electrical connections are plugged in and accessories are functioning properly before reinstalling the fascia.
- The baseplate is computer tested to your vehicle's GVWR, exceeding this weight will void the manufacturer's warranty.
- Be sure to use Loctite® Red on all bolts before tightening. Tighten all bolts according to the torque chart provided.
- Dealer or installer be certain the user receives these instruction sheet.
- If the baseplate is in an accident, it must be replaced. **DO NOT** use it again! An accident can cause unseen damage and using it again could result in more damage or serious injury. **DO NOT** use the baseplate if it is damaged or missing parts.

BX1836

2005-15 Nissan Xterra Installation Instructions

Tools Required

Large Vise Grip
 Flat Screwdriver
 Utility Knife
 Phillips Screwdriver
 Torque Wrench
 Drill
 Reciprocating Saw
 Tape Measure
 Loctite® RED
 17/32" Drill Bit
 1-1/4" Hole Saw
 10MM Socket
 17MM Socket
 19MM Socket
 3/4" Socket

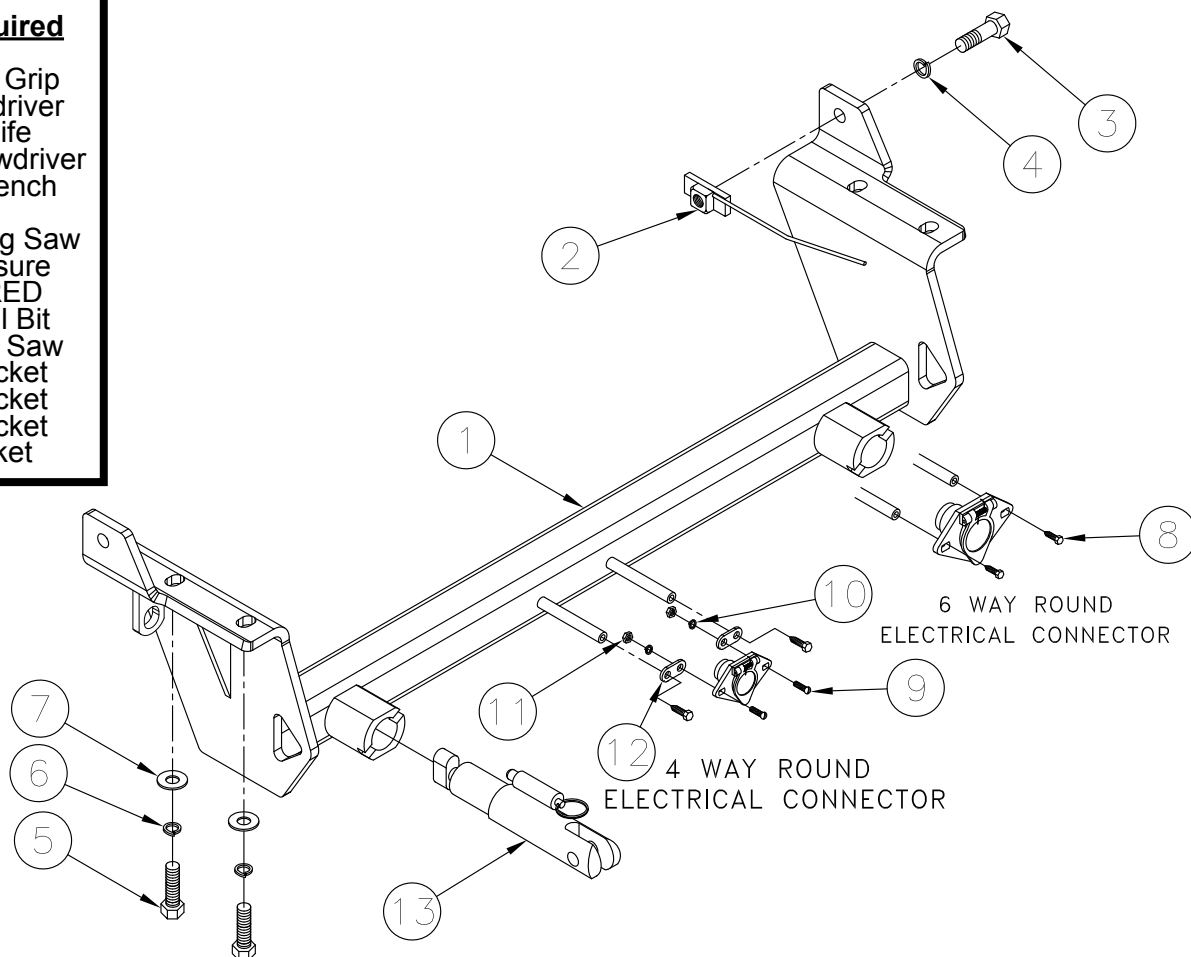

Item No.	Part No.	Description	Qty.
1	61-6161	BX1836 Baseplate	1
2	61-3799	1/2"-13 Nut Plate w/ 10" Wire	2
3	201-0051	1/2"-13 x 1-1/2" Hex Head Bolt, Grade 5, ZP	2
4	203-0012	1/2" Lock Washer, ZP	2
5	201-0603	12MM-1.25 x 45MM Hex Head Bolt, Grade 8.8, ZP	4
6	203-0105	12MM Lock Washer, ZP	4
7	203-0005	1/2" Flat Washer, ZP	4
8	201-0979	#12-14 x 1" Self Drilling Screw, ZP	2
9	201-0192	#10-32 1/2" Round Slotted Head Screw	2
10	203-0054	#10 Lock Washer, ZP	2
11	202-0047	#10-32 Hex Nut	2
12	101-5822	4 Way Connector Adapter	2
13	62-3468	Attachment Tab Assembly with Hole	2
14	226-0049(not shown)	Class IV Safety Cables	2
15	229-0512(not shown)	1/2" Quicklink, ZP	4
16	290-0437(not shown)	Black Cap Plug Receiver	2

Important:

Use only genuine factory replacement parts on your baseplate. Do **NOT** substitute homemade or non-typical parts. If a bolt is lost or in need of replacement, for your safety and the preservation of your baseplate, be sure to use a replacement bolt of the same grade (In most cases it will be Grade 5, please reference the parts list above). Replacement parts may be ordered through your nearest Blue Ox® Dealer or Distributor. Failing to follow and/or altering these installation instructions in either installation or required equipment will void the manufacturer's warranty. Towing behind a non-motorized vehicle will void the warranty.

BX1836
2005-15 Nissan Xterra
Installation Instructions

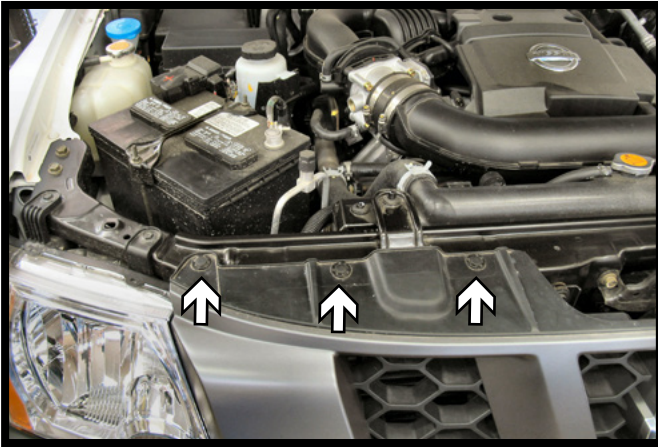

1. Remove the six (6) push pins from the top edge of the grille. There are three (3) on each side of the vehicle.



2. Pull the grille forward in order to release the clip on the back. Pull up and release four (4) clips along the bottom of the front fascia. Set the fascia aside.

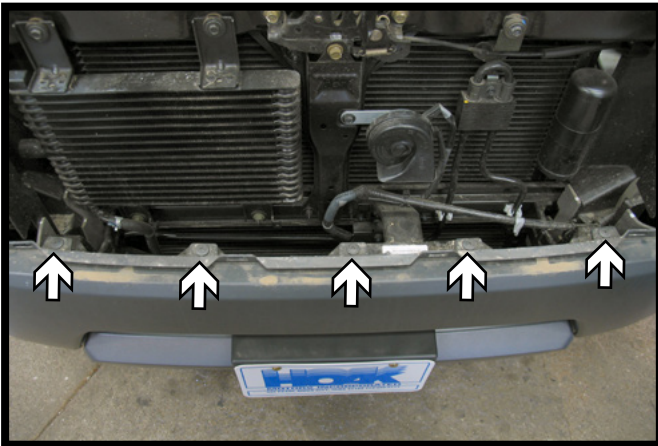

3. Remove the five (5) push pins from the top edge of the fascia.

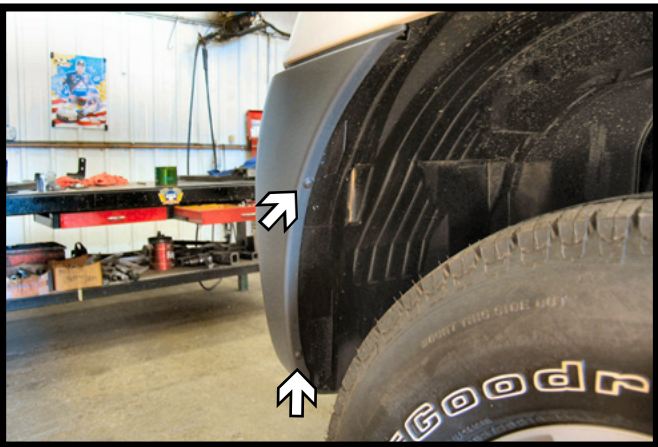

4. Using a Phillips screwdriver, remove the two (2) screws from the wheel well. Do this on both sides of the vehicle.

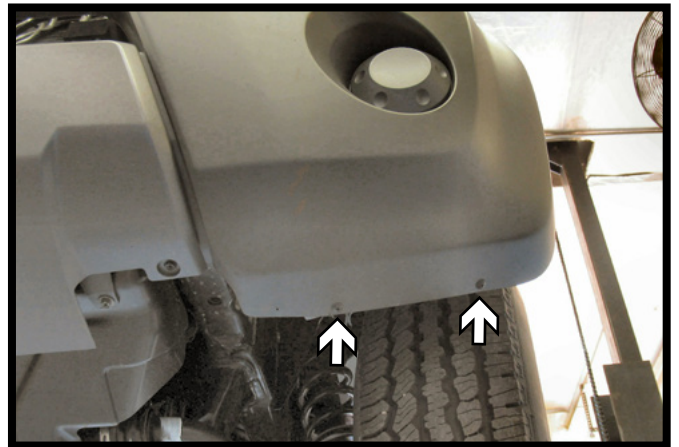

5. Using a Phillips screwdriver, remove the four (4) screws from the underside of the fascia. There are two (2) on each side.

BX1836
2005-15 Nissan Xterra
Installation Instructions

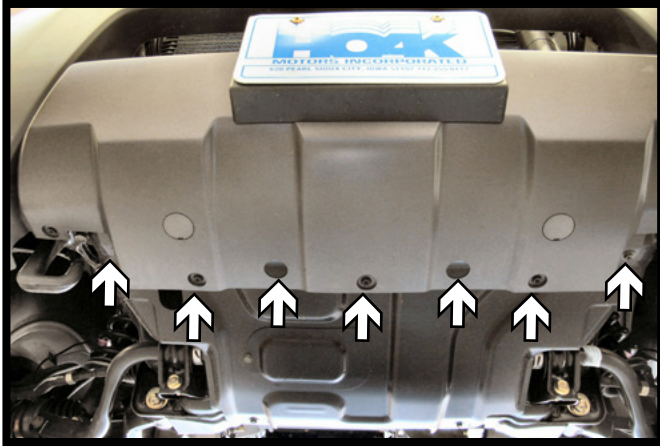

6. Using a 10MM socket, remove the seven (7) screws from the underside of the fascia.



7. Pull back the wheel well liner, remove the screw from the top edge of the fascia. Do this on both sides of the vehicle. Pull the fascia forwards disconnecting any electrical connections and set fascia aside.

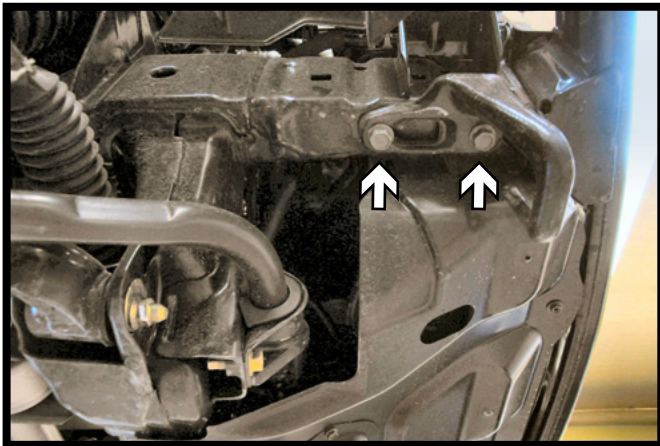

8. Using a 17MM socket, remove the two (2) bolts from the tow hook bracket. Do this on both sides of the vehicle. Tow Hooks will not be re-installed.

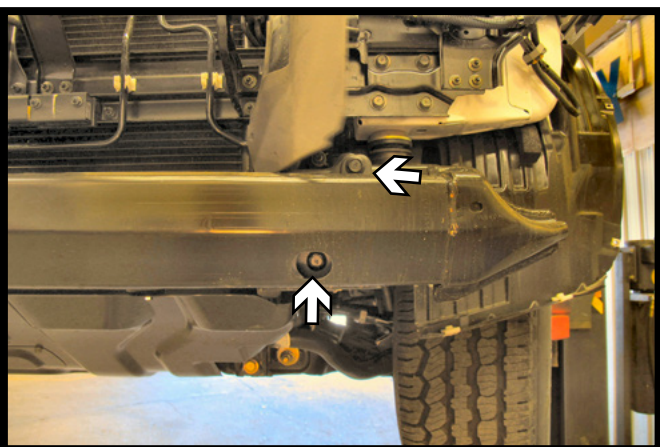

9. Using a 17MM socket, remove the four (4) bolts from the bumper. There are two (2) on each side. Set the bumper aside.

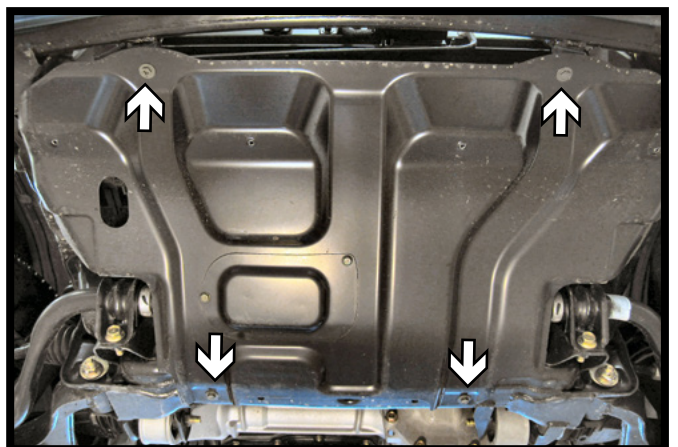

10. Remove the four (4) screws from the belly pan and set the pan aside.

BX1836
2005-15 Nissan Xterra
Installation Instructions

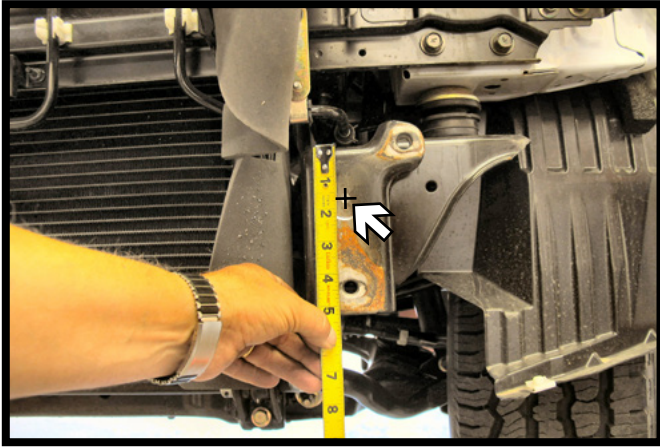

11. Using a 1-1/4" hole saw, drill an access hole 1-3/4" down from the top of the frame and centered side to side. Do this on both sides of the vehicle.

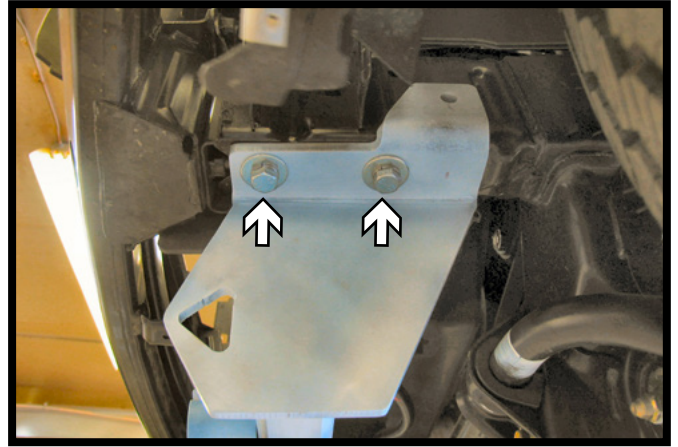

12. Position the baseplate onto the vehicle. Install 12MM-1.25 x 45MM bolts with 12MM lock and 1/2" flat washers into the existing holes. Do this on both sides of the vehicle. Fully tighten hardware.

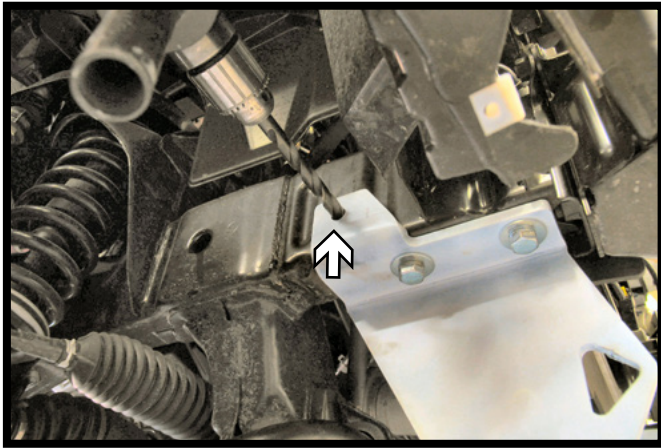

13. Using a 17/32" drill bit, drill the hole in the side of the baseplate thru the frame. Install a 1/2"-13 x 1-1/2" bolt with 1/2" lock washer into the hole and a 1/2" nut plate on the inside of the frame. Do this on both sides of the vehicle. Fully tighten hardware.

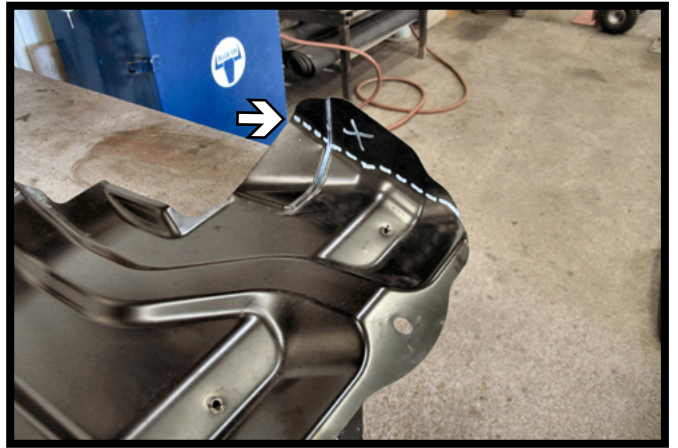

14. Using a reciprocating saw, trim the outer flange off the belly pan as shown. Do this on both side of the pan.

15. Attach the permanent baseplate safety cables to the provided convenience link on the baseplate. Additional options may interfere with suggested mounting; in this case, secure the cables to a solid piece of the frame as described in the instructions included with the permanent baseplate safety cables. Be sure the safety cables do not rub against any hoses or moving parts. Do this on **BOTH** sides of the vehicle.

BX1836
2005-15 Nissan Xterra
Installation Instructions



16. Reinstall the belly pan, bumper, fascia and grille.

CUSTOMER SERVICE COMMITMENT

Blue Ox® is committed to providing you with exceptional customer care throughout your lifetime with our products. Our team is here to assist you with any questions you may have regarding the performance of your product. Simply call (402) 385-3051 and you can speak with our customer care team.

Additionally, please visit our website to see which rallies our Destination America team will be attending. For a nominal fee, our service technician will service your towing system to ensure it's in proper working condition. Also, as a commitment to our customers, should you visit our factory, you can stay at our full service Blue Ox® campground at no charge along with enjoying a factory tour.

Again, thank you for being our customer and for the confidence you have shown in the performance of our products. It is because of customers like you we enjoy the success we have today.

© 2015 Blue Ox
One Mill Road, Industrial Park
Pender, Nebraska 68047
Phone: (402) 385-3051
Fax: (402) 385-3360
www.blueox.com