

Serial Number

Please read **BOTH** these Installation Instructions and the General Towing Instructions before attempting to install or operate this equipment.

- Blue Ox® towing products and accessories are intended to be installed by Blue Ox® Dealers who are familiar with our products and have the equipment and knowledge to do “fit work”. When necessary, Blue Ox® Dealers can be found at www.blueox.us or by contacting our Customer Care Department at (888) 425-5382.
- Many Blue Ox® Baseplates are designed to use existing holes and hardware to mount the baseplate to the towed vehicle. Even though bolts are there, do not assume they are adequate for baseplate mounting. Always use hardware supplied in the hardware kit or existing hardware specified in the Baseplate Installation Instructions.

Attachment Tab Height: 14”
Attachment Tab Width: 26”

Bolt Torque Specifications
Torque in Foot-Pounds per Metric Bolts

Bolt Size	Grade 8.8	Grade 10.9
6MM	6	8
8MM	16	22
10MM	31	40
12MM	54	70
14MM	89	117

Confirm the towability and pre-towing procedures for your vehicle with the owner’s manual or contact the vehicle’s manufacturer for specific towing procedures. You can also contact REMCO for additional information at 1(800)228-2481.

Bolt Torque Specifications
Torque in Foot-Pounds per Inch Bolts

Bolt Size	Grade 5	Grade 8
1/4”	10	14
5/16”	19	29
3/8”	33	47
7/16”	54	78
1/2”	78	119
5/8”	154	230



⚠ WARNING

Failure to read and follow these instructions could result in separation of the towed vehicle from the tow bar, causing property damage, loss of towed vehicle, personal injury or death.

BX1838
2007-09 Nissan Versa
Installation Instructions

Parts List

Ref. No.	Qty.	Part #	Description
1	1	61-6307	Weldment, Base Plate, BX1838
2	2	61-5208	3/8-16 Nut Plate, with 14" Wire
3	7	201-0368	3/8-16 x 1 1/4" Hex Head Bolt, Grd. 5, ZP
4	7	203-0010	3/8" Lock Washer, ZP
5	3	203-0003	3/8" Flat Washer
6	5	202-0003	3/8-16 Hex Nut, ZP
7	2	201-0979	#12-14 X 1" Self Drilling Screw, ZP
8	2	201-0192	#10-32 x 1/2 Slot, Rd. Hd. Screw
9	2	203-0054	#10 Lock Washer
10	2	202-0047	#10-32 Hex Nut
11	2	101-5822	Adapter, 4 Way Connector
12	2	62-3469	Attachment, Assembly, SF/LB (R)
	2	290-0437	Receiver Cap Plug, Black (Not Shown)
	2	229-0359	Quick Link, 3/8" ZP (Not Shown)
	2	226-0046	Baseplate Safety Cable, 36" CL III (Not Shown)

Tools Required

- 10mm Ss
- 14mm Ss
- 16mm Ss
- 9/16" So
- 13/32" D

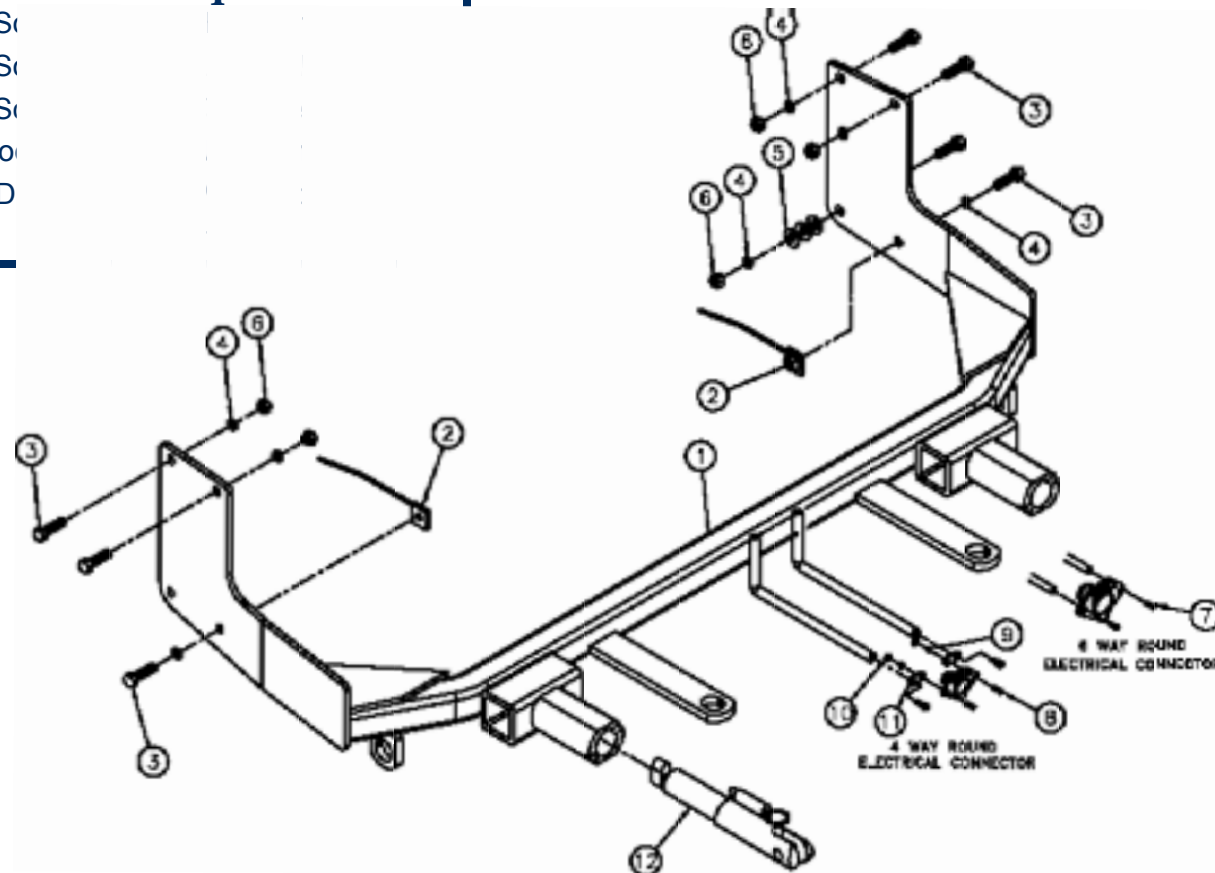

Important:

Use only genuine factory replacement parts on your baseplate. Do **NOT** substitute homemade or non-typical parts. If a bolt is lost or in need of replacement, for your safety and the preservation of your baseplate, be sure to use a replacement bolt of the same grade (In most cases it will be Grade 5, please reference the parts list above). Replacement parts may be ordered through your nearest Blue Ox® Dealer or Distributor.

BX1838
2007-09 Nissan Versa
Installation Instructions

Attachment Tabs:

Due to the design of the removable tabs, the RangeFinderII and Ambassador tow bars can not be used. Adapters, except the BX8833 and BX88151, can not be used with this baseplate.

Installation Notes: The radiator cover, fascia, styrofoam bumper, washer reservoir, metal bumper and headlights are removed for installation. Trimming of the air dams and frame rail webbing is required. Drilling is required.

The dimensional variations between otherwise identical vehicles can be considerable. While the baseplate was designed for easy installation, it may be necessary to tailor the baseplate slightly to compensate for auto manufacturer's tolerances. These minor adjustments may include filing a hole slightly, bending electrical rods, and/ or bending end plates.

The BX8869 Bulb and Socket Wiring Kit is recommended for this vehicle.

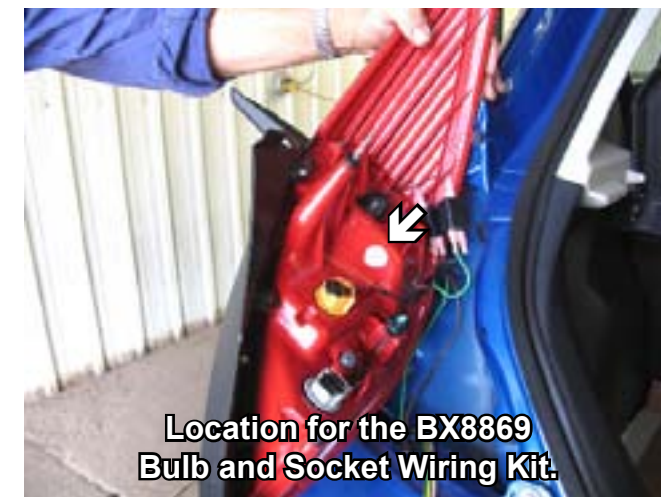

Installation Instructions:



1. Remove two pushpins from the air intake scoop. Set pushpins aside to be reinstalled later.



2. Remove eleven pushpins from the top of radiator cover. Lift radiator cover to remove. Set pushpins and radiator cover aside to be reinstalled later.

BX1838
2007-09 Nissan Versa
Installation Instructions



3. Remove four pushpins from the top of the fascia. Set pushpins aside to be reinstalled later.



4. Remove three metric bolts from the lower corner of fascia using the 10mm socket. To remove the bolt just forward of the front tire, push fascia corner - where it meets bolt - out and then forward. Do this to both sides of the vehicle. Set bolts aside to be reinstalled later.

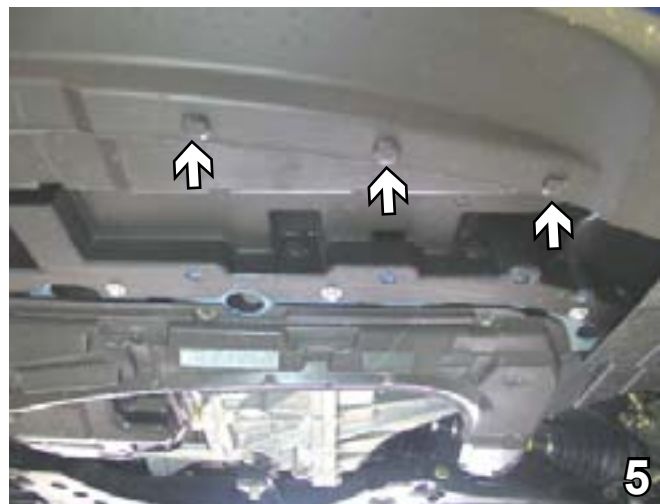

5. Remove three pushpins from the lower front edge of fascia. Do this to both sides of the vehicle. Set pushpins aside to be reinstalled later.



6. Push wheel well cover aside to remove one metric bolt using the 10mm socket. Do this to both sides of the vehicle. Pull fascia forward to remove. Pull styrofoam bumper forward to remove from front of metal bumper. Set fascia, styrofoam bumper and bolts aside to be reinstalled later.

BX1838
2007-09 Nissan Versa
Installation Instructions



7. On the passenger's side, disconnect electrical connection from the washer reservoir. Disconnect and plug the reservoir. Remove one metric bolt from the reservoir's lower bracket using the 10mm socket.



8. Remove one metric bolt from the washer reservoir's upper bracket (see white arrow) using the 10mm socket. Disconnect the fill tube from the top of reservoir (see grey arrow). Remove washer reservoir. Set bolts and reservoir aside to be reinstalled later.



9. On the driver's side, using the utility knife, start cutting the air dam at the bottom of the tab (see white arrow). Cut to the bottom of the air dam. Remove one pushpin from metal bumper securing the air dam (see grey arrow). Remove cut portion of air dam. Pushpin will not be reinstalled.



10. On the passenger's side, using the utility knife, start cutting the air dam at the bottom of the tab (see white arrow) and cut across until reaching the back seam of air dam. Cut to the bottom of the air dam, following the inside edge of seam. Remove one pushpin from metal bumper securing the air dam (see grey arrow). Remove cut portion of air dam. Pushpin will not be reinstalled.

BX1838
2007-09 Nissan Versa
Installation Instructions



11. On the driver's side, mark the frame rail webbing 5", 6 1/2" and 8 3/4" from the top of the frame rail. Using the reciprocating saw, just cut the webbing to the frame rail (the top cut goes through bumper bracket also). Cut and remove the upper section of webbing (see white arrow). Flatten the lower cut webbing section flush against the frame rail (see grey arrow) with hammer.

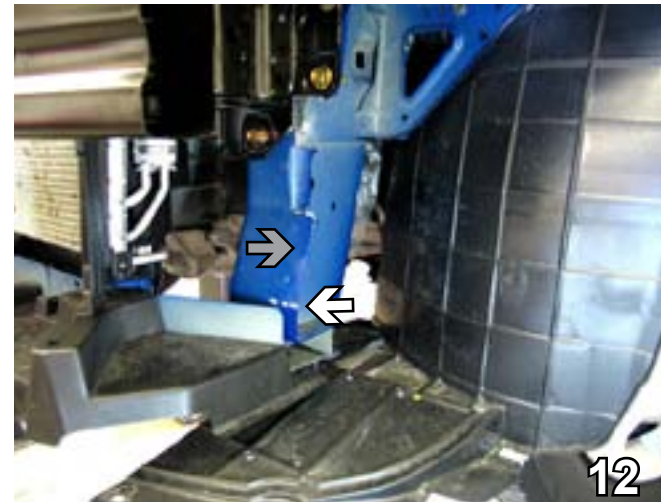

12. Cut the lower portion of webbing where it begins to angle down (see white arrow). Using the reciprocating saw, just cut from the webbing of the frame rail. Flatten this section (above the cut, not below it) flush against the frame rail (see grey arrow) with hammer. Do this to both sides of the vehicle.

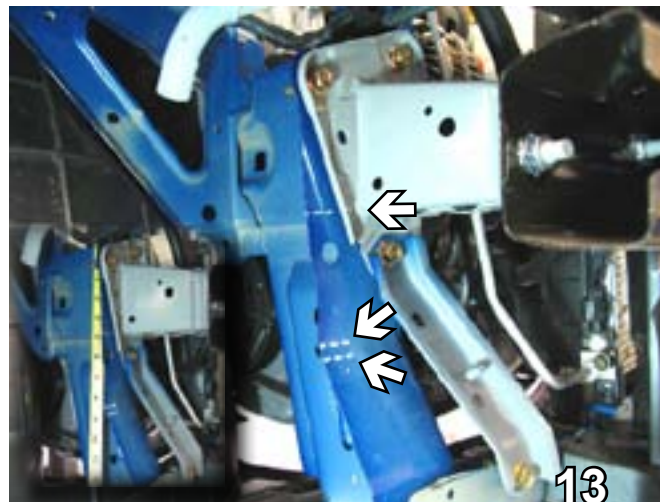

13. On the passenger's side, using the tape measure (see inset), mark the frame rail webbing 5", 8 1/2" and 8 3/4" from the top of the frame rail (see white arrows). Using the reciprocating saw, cut the webbing only to the edge of frame rail (the top cut goes through bumper bracket also). Flatten all sections flush against the frame rail with hammer.

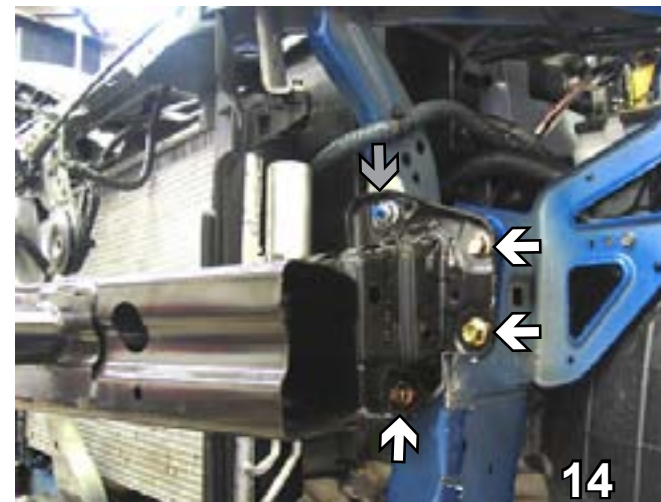

14. On the driver's side, using the 16mm socket, remove one metric bolt from the top of the metal bumper bracket (see grey arrow). Using the 14mm socket, remove the three remaining metric bolts from the bumper bracket (see white arrows). Set bolts aside to be reinstalled later.

BX1838
2007-09 Nissan Versa
Installation Instructions

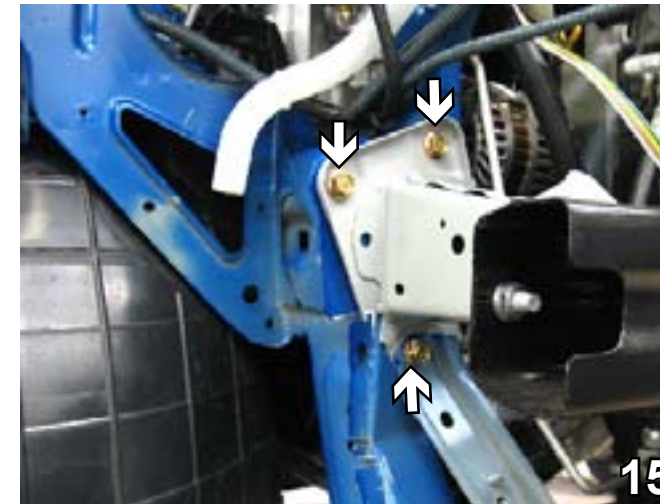

15. On the passenger's side, using the 14mm socket, remove three metric bolts from the bumper bracket. Pull metal bumper forward to remove. Remove four metric bolts from the headlight using the 10mm socket. Do this to both sides of the vehicle. Set bolts, bumper and headlights aside to be reinstalled later.

BE SURE TO USE LOCTITE® RED ON ALL BOLTS BEFORE TIGHTENING. TIGHTEN ALL BOLTS ACCORDING TO THE TORQUE CHART ON THE FRONT PAGE OF THESE INSTRUCTIONS OR ON PAGE 3 OF THE BASEPLATE TOWING GENERAL INSTRUCTIONS.

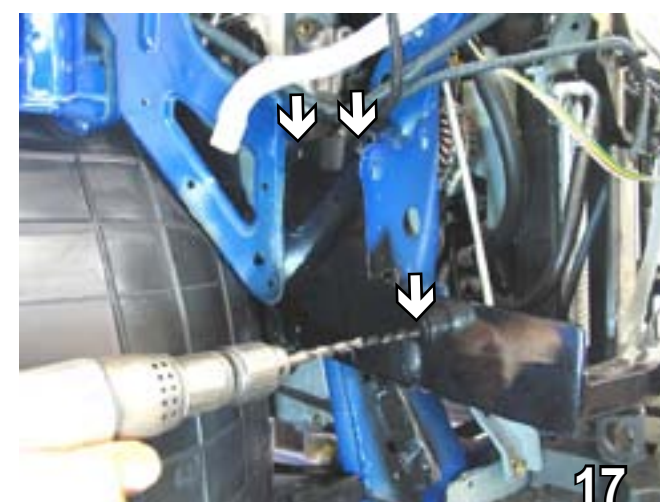

17. On the passenger's side, use the baseplate as a template to drill three holes into the frame rail with the 13/32" drill bit (lower back hole is not used). Insert one 3/8-16 nut plate through frame opening and align to bottom drilled hole. Install 3/8-16 x 1 1/4" bolt with 3/8" lock washer and tighten. In upper holes, install 3/8-16 x 1 1/4" bolts with 3/8" lock washers and 3/8-16 hex nuts and tighten.

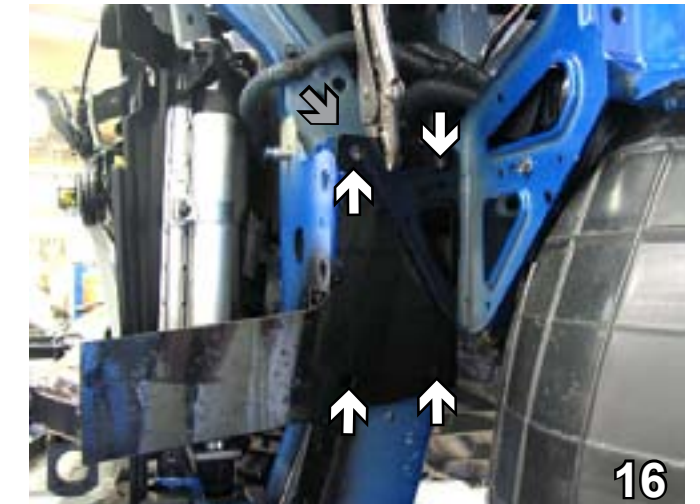

16. Align the top front edge of the baseplate with the top of the frame rail (see grey arrow) and pull the baseplate as far forward as possible. The top back edge of baseplate will dip slightly below the top of the frame rail. Clamp baseplate into place using the vise grips. Do this to both sides of the vehicle. On the driver's side, use the baseplate as a template to drill four holes (see white arrows) into the frame rail with the 13/32" drill bit.

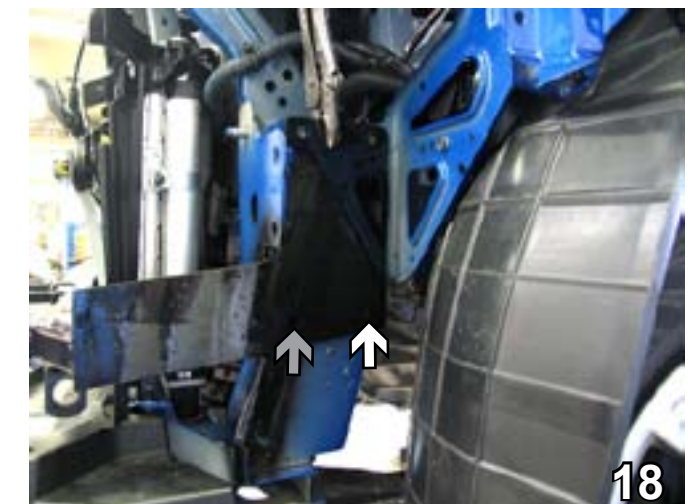

18. On the driver's side, insert one 3/8-16 nut plate through frame opening and align to lower front hole. Install 3/8-16 x 1 1/4" bolt with 3/8" lock washer and tighten (see grey arrow). Install 3/8-16 x 1 1/4" bolt to lower back hole (see white arrow) with three 3/8" flat washers, 3/8" lock washer and 3/8-16 hex nut and tighten. In upper holes, install 3/8-16 x 1 1/4" bolts with 3/8" lock washers, 3/8-16 hex nuts and tighten.

BX1838
 2007-09 Nissan Versa
 Installation Instructions

Be sure that **ALL** electrical connections are plugged in properly and functioning **BEFORE** installing the fascia.

19. Reinstall the metal bumper, washer reservoir, styrofoam bumper, fascia, radiator cover, pushpins and bolts.

Install the tow bar and safety cables according to the instructions provided in their packages. When demonstrating this to the customer, be sure to include all the contents and packages.

Do **NOT** substitute other devices if the tow bar pins and clips are misplaced.

DEALER or INSTALLER:
 Be certain the user receives the instruction sheets for their products.

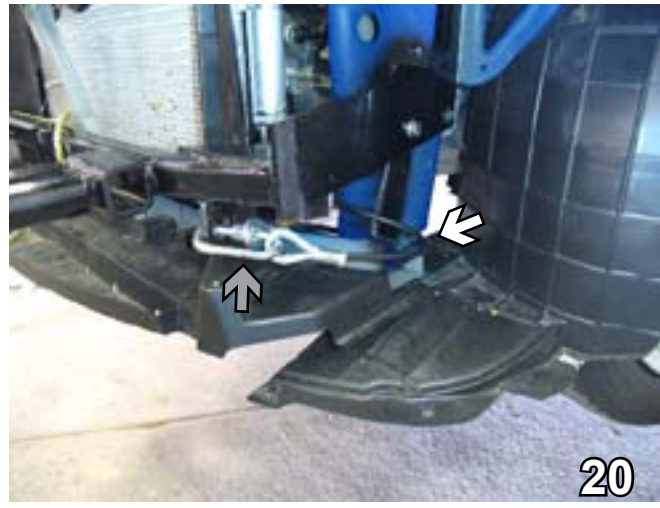

20. Attach the permanent baseplate safety cables to the provided convenience link on the baseplate (see grey arrow). The photo above shows the recommended installation of the permanent baseplate safety cables to frame of the vehicle (see white arrow). If the vehicle has additional options, not shown above, which interfere with mounting the permanent baseplate safety cables, secure the cable to a solid piece of the vehicle's frame as described in the instructions included with the permanent baseplate safety cables.

BX1838
 2007-09 Nissan Versa
 Installation Instructions

CUSTOMER SERVICE COMMITMENT

Blue Ox is committed to providing you with exceptional customer care throughout your lifetime with our products. Our team is here to assist you with any questions you may have regarding the performance of your product. Simply call 1-800-228-9289 and you can speak with our customer care team.

Additionally, please visit our website to see which rallies our Destination America team will be attending. For a nominal fee, our service technician will service your towing system to ensure it's in proper working condition. Also as a commitment to our customers, should you visit our factory you can stay at our full service Blue Ox campground at no charge along with enjoying a factory tour.

Again thank you for being our customer and for the confidence you have shown in the performance of our products. It is because of customers like you we enjoy the success we have today.



2007 Nissan Versa
 Shown without removable tabs installed.



2007 Nissan Versa
 Shown with removable tabs installed.



2008 Nissan Versa
 Shown with removable tabs installed.



© 2006, 07, 08, 09 Blue Ox
 One Mill Road, Industrial Park
 Pender, Nebraska 68047
 Phone: (402) 385-3051
 Fax: (402) 385-3360
 www.blueox.us