



BLUE OX®

Baseplate Installation Instructions

BX1841

2008-12 Nissan Altima Installation Instructions

Serial Number

Please read BOTH these Installation Instructions and the General Instructions before attempting to install or operate this equipment.

- Blue Ox® towing products and accessories are intended to be installed by Blue Ox® Dealers who are familiar with our products and have the equipment necessary and knowledge to do "fit work". When necessary Blue Ox® Dealers can be found at www.blueox.com or by contacting our Customer Care Department at (402) 385-3051.
- Many Blue Ox® Baseplates are designed to use existing holes and hardware to mount the baseplate to the towed vehicle. Even though bolts are there, do not assume they are adequate for baseplate mounting. Always use hardware supplied in the hardware kit and existing hardware specified in the Baseplate Installation Instructions.

Attachment Tab Height: 14"

Attachment Tab Width: 24"

Bolt Torque Specifications
Torque in Foot-Pounds for Metric Bolts

Bolt Size	Grade 8.8	Grade 10.9
6MM	6	8
8MM	16	22
10MM	31	40
12MM	54	70
14MM	89	117

Confirm the towability and pre-towing procedures for your vehicle with the owner's manual or contact the vehicle's manufacturer for specific towing procedures.

Bolt Torque Specifications
Torque in Foot-Pounds for Inch Bolts

Bolt Size	Grade 5	Grade 8
1/4"	10	14
5/16"	19	29
3/8"	33	47
7/16"	54	78
1/2"	78	119
5/8"	154	230

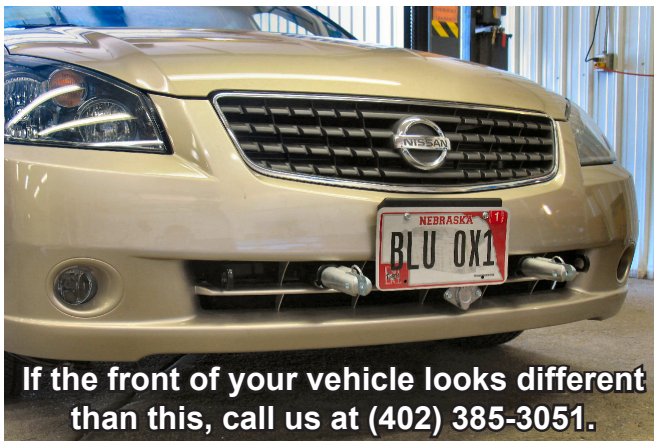

If the front of your vehicle looks different than this, call us at (402) 385-3051.

WARNING
Failure to read and follow these instructions could result in separation of the towed vehicle from the tow bar, causing property damage, loss of towed vehicle, personal injury or death.

BX1841 2008-12 Nissan Altima Installation Instructions

Parts List

Ref. No.	Qty.	Part #	Description
1	1	61-6492	WLDM'T, BASEPLATE, BX1841
2	4	61-5208	WLDT, NUT PLT, 1/4X1X1, 3/8 BLT WIR
3	2	61-4978	3/8 INCH WHIZ NUT WITH 14 INCH WIRE
4	6	201-0440	3/8-16 X 1 1/2 HEX BOLT, GRD.5, ZP
5	6	203-0010	3/8 LOCK WASHER, ZP
6	2	201-0979	#12-14 x 1" Self Drilling Screw, ZP
7	2	201-0192	110-32 X 1/2 SLOT, RD. HD. SCREW
8	2	203-0054	#10 LOCK WASHER
9	2	202-0047	#10-32 HEX NUT
10	2	101-5822	ADAPTER, 4 WAY CONNECTOR
11	2	62-3469	ATT TAB ASSY, REM, SF/LB, 1 HOLE
	3	201-0655	6MM-1.0 X 30MM HEX BOLT, GRD8.8,ZP (Not Shown)
	15	203-0001	1/4 FLAT WASHER, ZP (Not Shown)
	2	226-0046	BASEPLATE SAFETY CABLE, 36" CL III (Not Shown)
	2	229-0359	QUICKLINK, 3/8, ZP (Not Shown)
	2	290-0437	RECEIVER, CAP PLUG (BLK) (Not Shown)

Tools Required

10MM Socket	Phillips Screw Driver
13MM Socket	Flat Screw Driver
Utility Knife	9/16" Socket
13/32" Drill Bit	Reciprocating Saw
Loctite® RED	Large Vise Grips

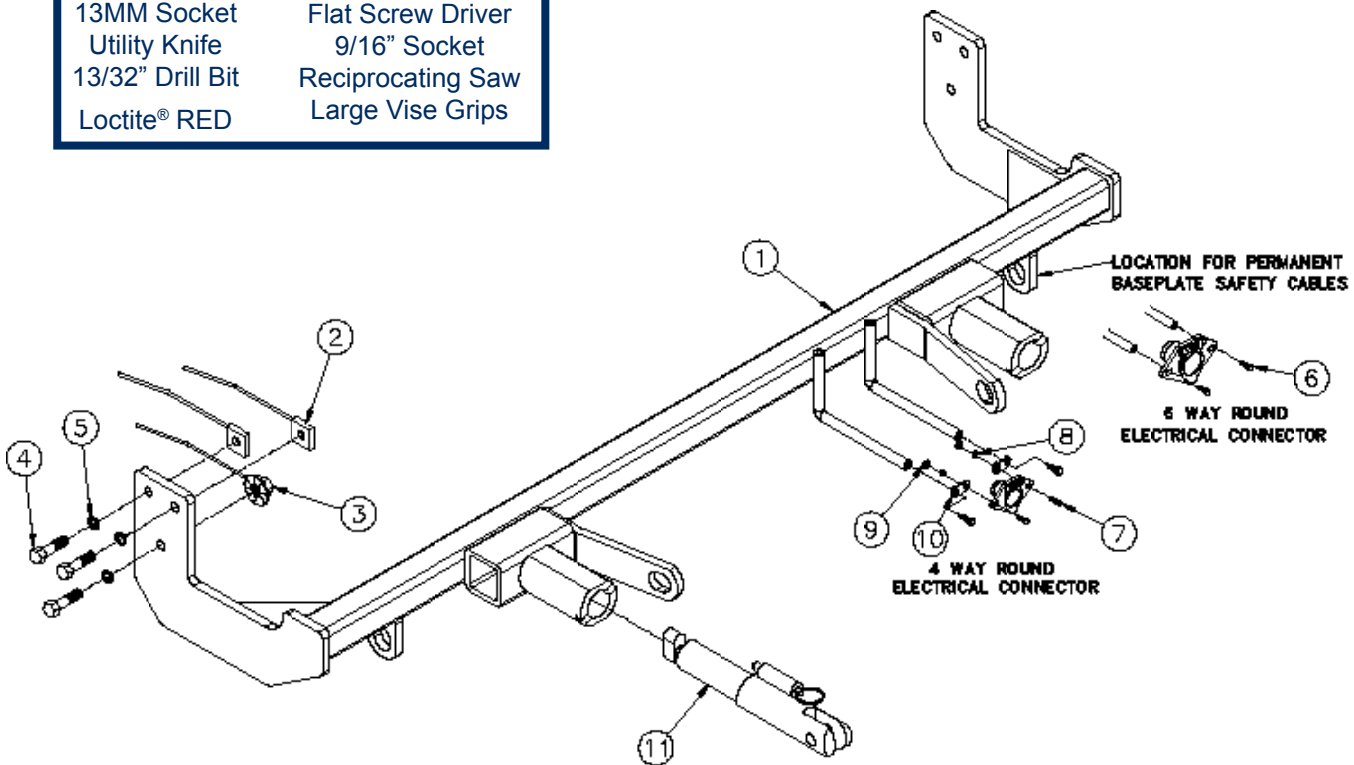

Important:

Use only genuine factory replacement parts on your baseplate. Do **NOT** substitute homemade or non-typical parts. If a bolt is lost or in need of replacement, for your safety and the preservation of your baseplate, be sure to use a replacement bolt of the same grade (In most cases it will be Grade 5, please reference the parts list above). Replacement parts may be ordered through your nearest Blue Ox® Dealer or Distributor, or call our Customer Care Team at (402)385-3051. Failing to follow and/or altering these installation instructions in either installation or required equipment will void the manufacturer's warranty.

BX1841 2008-12 Nissan Altima Installation Instructions

Attachment Tabs:

Due to the design of the removable tabs, the RangeFinderII tow bar can not be used. Adapters, except the BX8833 and BX88151, can not be used with this baseplate.

Instructions:

The front fascia, bumper, horn and windshield washer reservoir are removed for the baseplate installation.

The dimensional variations between otherwise identical vehicles can be considerable. While the baseplate was designed for easy installation, it may be necessary to tailor the baseplate slightly to compensate for auto manufacturer's tolerances. These minor adjustments may include filing a hole slightly, bending electrical rods or bending end plates.

The Bx8869 Bulb and Socket Wiring Kit is recommended for this vehicle.



Handling of some cosmetic parts when installing this product may require the use of protective covers, rags, specialty tools, etc. to prevent damage.

Installation Instructions:

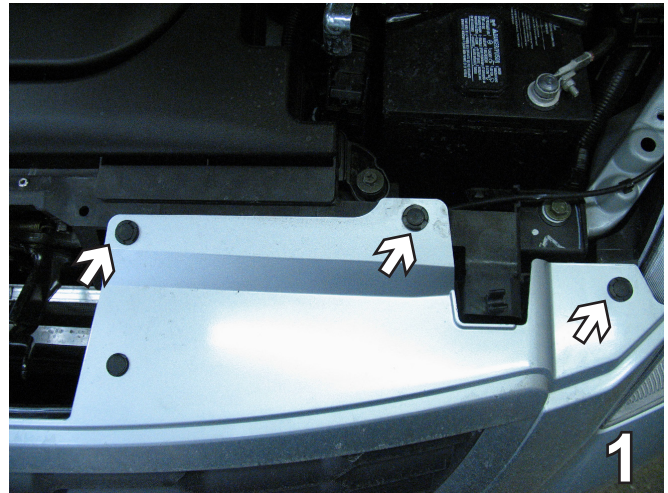

1. Remove three push pins from the top of the front fascia and set aside to be re-installed later. This is done on both sides, the driver's side is shown.



2. On the underside edge of the front fascia remove three Phillips screws. Set aside to be re-installed later. This will need to be done to both sides of the vehicle, the driver's side is shown.

BX1841

2008-12 Nissan Altima

Installation Instructions



3. On the underside of the front fascia there are five push pins that need to be removed as indicated by the arrows in the picture. Set these aside as they will be re-installed later.



4. Using a 10MM Socket, remove one metric bolt from the inside of the wheel well, just forward of the front tires, and set aside to be re-installed later. This is done on both sides of the vehicle, the driver's side is shown. Pull the fascia corners out to the side of the vehicle, just above the front tire to release, both sides, then pull fascia forward and set aside carefully for later reinstallation.

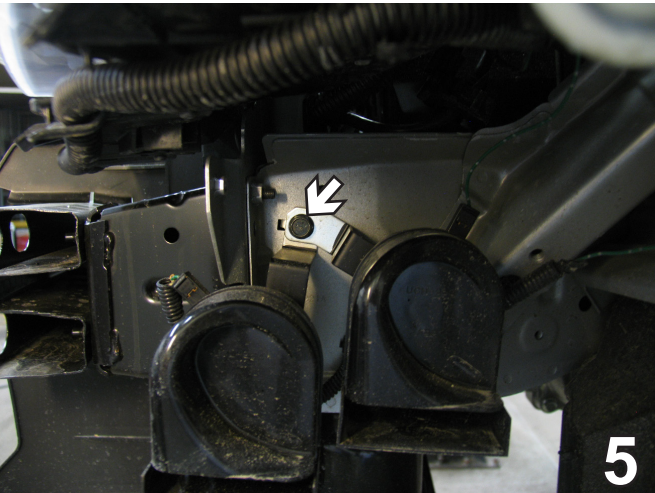

5. On the driver's side using a 13MM Socket, remove the metric bolt from the horn. Unplug and set aside to be reinstalled later.

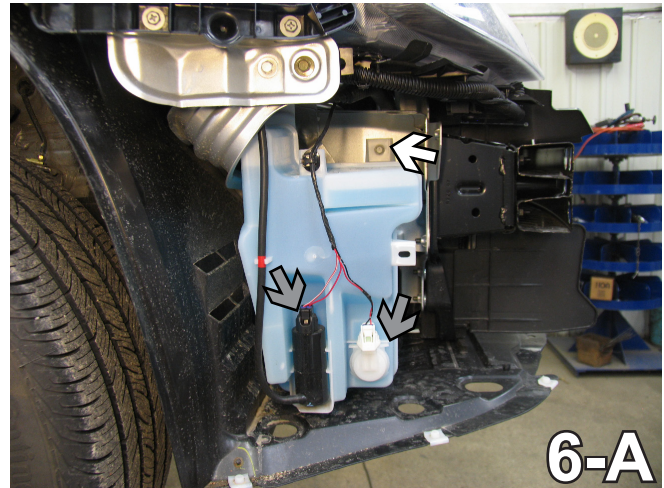

6. On the passenger side, remove the three metric bolts from the windshield washer reservoir with a 10MM Socket. Release the two wire clips from the electrical wires, then disconnect and plug the hose. Set all aside to be reinstalled later.

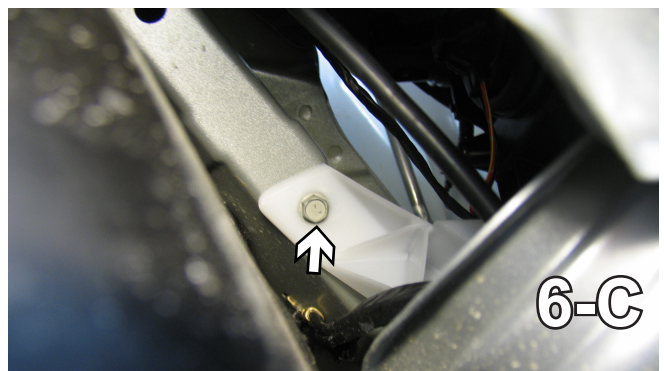

BX1841

2008-12 Nissan Altima

Installation Instructions

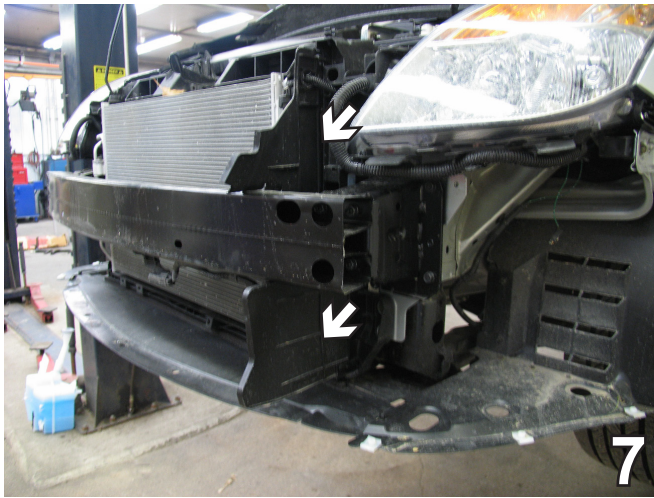

7. Remove the black plastic from above and below the frame extension by pulling it out. This is done on both sides of the vehicle.



8. Unplug the sensor by pulling the tabs out of the lower bumper.

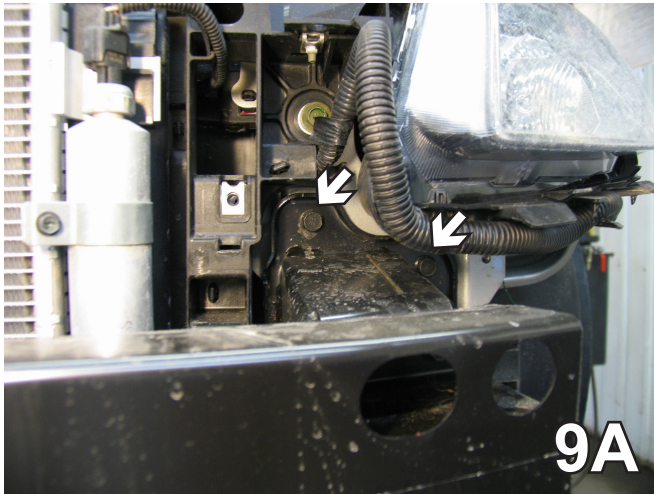

9A

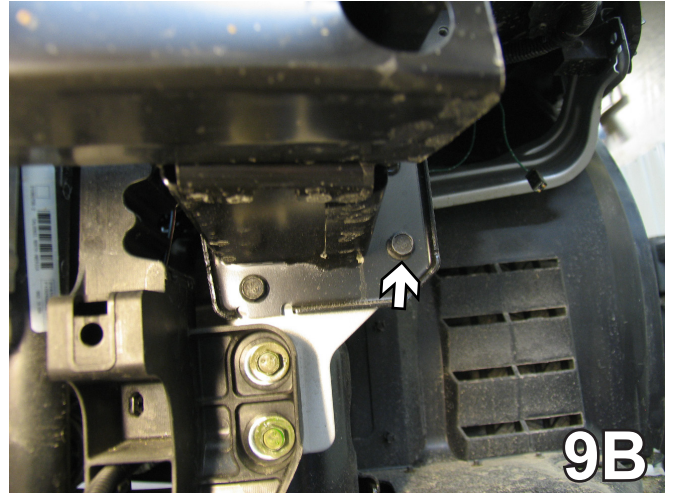

9B

9. Using a 13MM Socket, remove the four metric bolts from around the bumper. Do this on both sides. Remove the bumper and the frame extension, set aside to be reinstalled later.

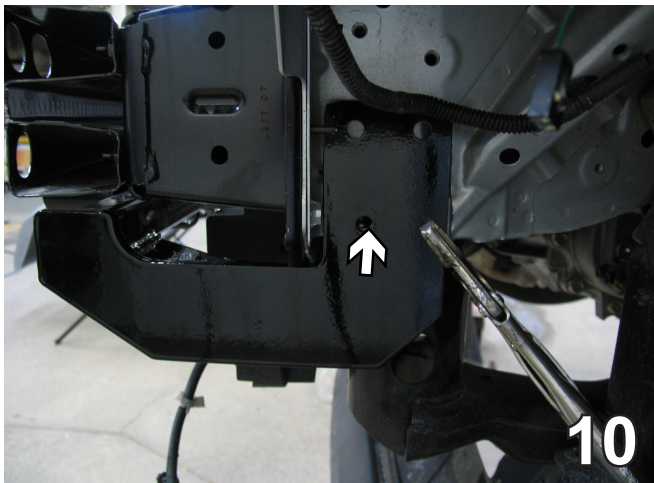

10

10. Lift the baseplate up and push it as far forward and up as possible. Be sure it is level with the vehicle, clamp with a vise grip. The lower hole should align in the middle of the lower frame webbing. Drill holes into lower hole of baseplate using a 13/32" drill bit. Insert 1 1/2" hex bolt, 3/8" lock washer and 3/8" whiz nut. Use Loctite Red on all bolts. Do this on both sides.

When using power drills be aware of the dangers of torque and drill bit length.

BX1841
2008-12 Nissan Altima
Installation Instructions

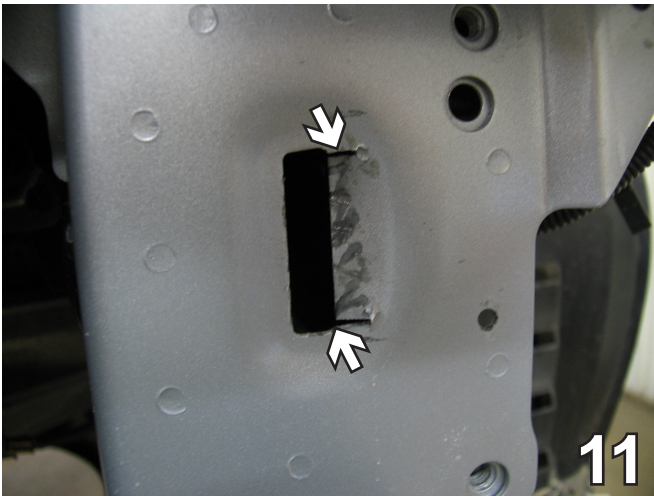

11. Using a reciprocating saw make a cut at the edge of the opening, bend the metal cut in. Do this on both sides.

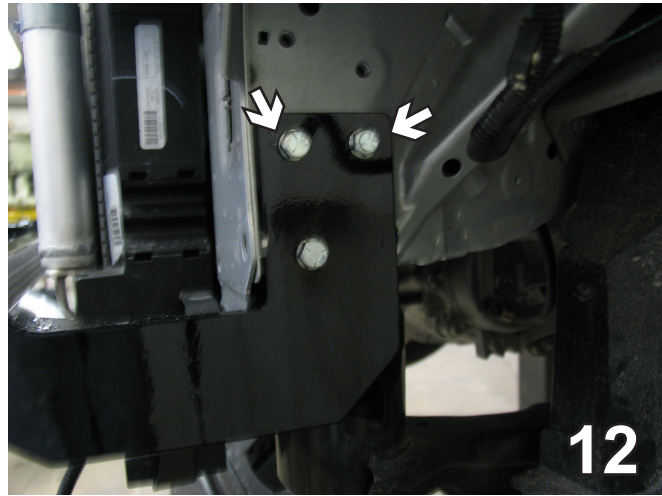

12. Insert 1 1/2" hex bolt and 3/8" lock washer into the top two holes and fasten to a 1" nut plate inserted through the opening on frame end. Use Loctite Red and torque to specifications. Do this on both sides.

****BE SURE TO USE LOCTITE® RED ON ALL BOLTS BEFORE TIGHTENING. TIGHTEN ALL BOLTS ACCORDING TO THE TORQUE CHART ON PAGE 1 OF THESE INSTRUCTIONS OR ON PAGE 3 OF THE BASEPLATE TOWING GENERAL INSTRUCTIONS.**

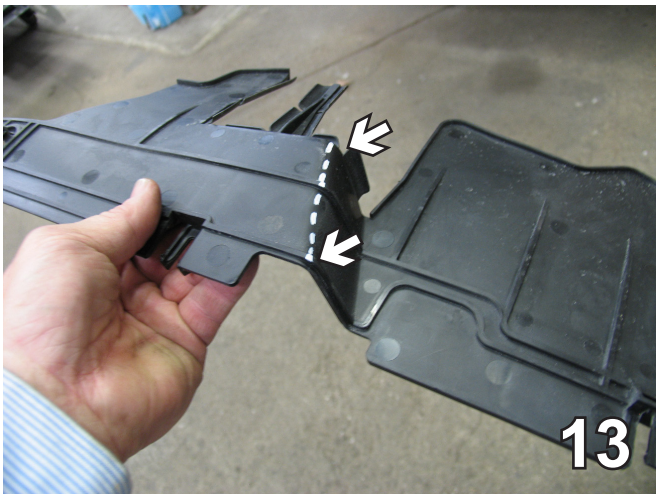

13. Cut the black plastic at the angle shown with a utility knife. Reinsert the top piece.
15. Install the permanent baseplate safety cables around a cross member or the frame and connect to the lower baseplate convenience link. See the drawing on page 2. Be sure the safety cables do not rub against any hoses or moving parts.

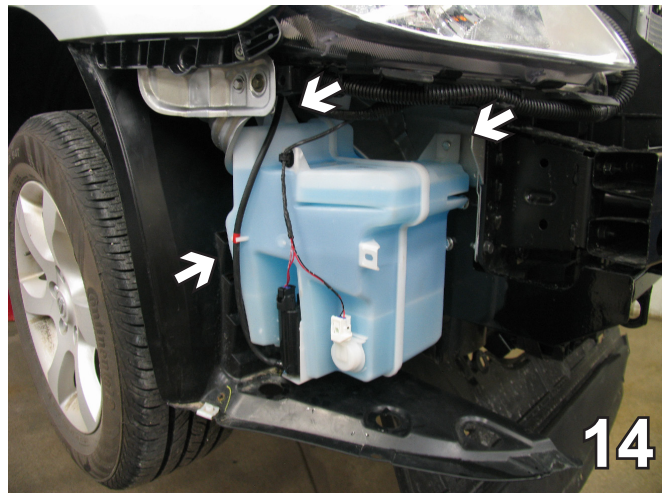

14. Reinstall the washer reservoir, use 30MM hex bolt with five 1/4" flat washers behind each tab.
16. Reinstall front fascia, bumper, horn, screws, push pins and bolts. Reconnect horn, sensor and windshield washer reservoir.
17. Install the tow bar and safety cables according to the instructions when demonstrating this to the customer. Be sure to include all the contents and packages of their Blue Ox products.
18. **DO NOT** substitute other devices if the tow bar pins and clips are misplaced.

BX1841

2008-12 Nissan Altima

Installation Instructions

Be sure that ALL electrical connections are plugged in properly and functioning BEFORE Installing the fascia.

DEALER or INSTALLER:
Be certain the user receives the instructions sheets for their products.



If the baseplate is in an accident, it must be replaced. DO NOT use it again! An accident can cause unseen damage and using it again could result in more damage or serious injury. DO NOT use the baseplate if it is damaged or missing parts.

CUSTOMER SERVICE COMMITMENT

Blue Ox is committed to providing you with exceptional customer care throughout your lifetime with our products. Our team is here to assist you with any questions you may have regarding the performance of your product. Simply call (402) 385-3051 and you can speak with our customer care team.

Additionally, please visit our website to see which rallies our Destination America team will be attending. For a nominal fee, our service technician will service your towing system to ensure it's in proper working condition. Also as a commitment to our customers, should you visit our factory you can stay at our full service Blue Ox campground at no charge along with enjoying a factory tour.

Again thank you for being our customer and for the confidence you have shown in the performance of our products. It is because of customers like you we enjoy the success we have today.



© 2008, 09, 10, 11 Blue Ox
One Mill Road, Industrial Park
Pender, Nebraska 68047
Phone: (402) 385-3051
Fax: (402) 385-3360
www.blueox.com
74/6/11