



# BX1986

## 2009-17 Dodge Ram 1500 (No Sport) Installation Instructions

Please read **BOTH** these Installation Instructions and the General Information sheet prior to installing or operating this equipment.

- Blue Ox® towing products and accessories are intended to be installed by Blue Ox® Dealers who are familiar with our products and have the equipment and knowledge necessary to do “fit work”. If needed, Blue Ox® Dealers can be found at [www.blueox.com](http://www.blueox.com) or by contacting our Technical Service Department at (402) 385-3051.
- Many Blue Ox® baseplates are designed to use existing holes and hardware to mount the baseplate to the towed vehicle. Even though bolts are there, do not assume they are adequate for baseplate mounting. Always use the hardware supplied in the hardware kit and existing hardware as specified in the installation instructions.

### Serial Number

**Attachment Tab Height: 18”**

**Attachment Tab Width: 34-1/2”**

### Bolt Torque Specifications

Torque in Foot-Pounds for Inch Bolts

Bolt Size	Grade 5	Grade 8
1/4”	10	14
5/16”	19	29
3/8”	33	47
7/16”	54	78
1/2”	78	119
5/8”	154	230
3/4”	257	380

### Bolt Torque Specifications

Torque in Foot-Pounds for Metric Bolts

Bolt Size	Grade 8.8	Grade 10.9
6MM	6	8
8MM	16	22
10MM	31	40
12MM	54	70
14MM	89	117
16MM	161	230
18MM	222	318



If the front of your vehicle looks different than this, please contact us at (402)385-3051.



## WARNING

Failure to read and follow these instructions could result in separation of the towed vehicle from the tow bar, causing property damage, loss of towed vehicle, personal injury or death.

**Reference your vehicle owner’s manual for manufacturer’s towing specifications.**

BX1986  
2009-17 Dodge Ram 1500 (No Sport)  
Installation Instructions

**Instruction Notes:** The lower air dam is removed and reinstalled for the baseplate installation. If equipped with tow hooks, the tow hooks are removed and stay off the vehicle. Some drilling and trimming is required.

Place all components that are removed on a flat, sturdy surface. All items will be reinstalled unless otherwise noted after the baseplate is installed.

The dimensional variations between otherwise identical vehicles can be considerable. While the baseplate was designed for easy installation, it may be necessary to tailor the baseplate slightly to compensate for vehicle manufacturer's tolerances.

The BX8869 Tail Light Wiring Kit is recommended for 2009-12 vehicles.

The BX8848 Diode Wiring Kit is recommended for 2013-16 vehicles.

## **NOTICE**

- Handling of some cosmetic parts when installing this product may require the use of protective covers, rags, specialty tools, etc. to prevent damage.
- When using power drills be aware of the dangers of torque and drill bit length.
- When using a reciprocating saw be aware of objects behind the cutting surface.
- Use a good quality paint to spray cut edges of frame to prevent rusting.
- Be sure that **ALL** electrical connections are plugged in and accessories are functioning properly before reinstalling the fascia.
- The baseplate is computer tested to your vehicle's GVWR, exceeding this weight will void the manufacturer's warranty.
- Be sure to use a sufficient amount of Loctite® Red on all bolt threads before tightening. Tighten all bolts according to the torque chart provided.
- Dealer or installer be certain the user receives these instruction sheets.
- If the baseplate is in an accident, it must be replaced. **DO NOT** use it again! An accident can cause unseen damage and using it again could result in more damage or serious injury. **DO NOT** use the baseplate if it is damaged or missing parts.

# BX1986

## 2009-17 Dodge Ram 1500 (No Sport)

### Installation Instructions

#### **Tools Required**

Large Vise Grips  
 Utility Knife  
 Torque Wrench  
 Drill  
 Tape Measure  
 Loctite® RED  
 1-1/4" Hole Saw  
 17/32" Drill Bit  
 1/4" Drill Bit  
 10MM Socket  
 18MM Socket  
 3/4" Socket  
 3/4" Wrench

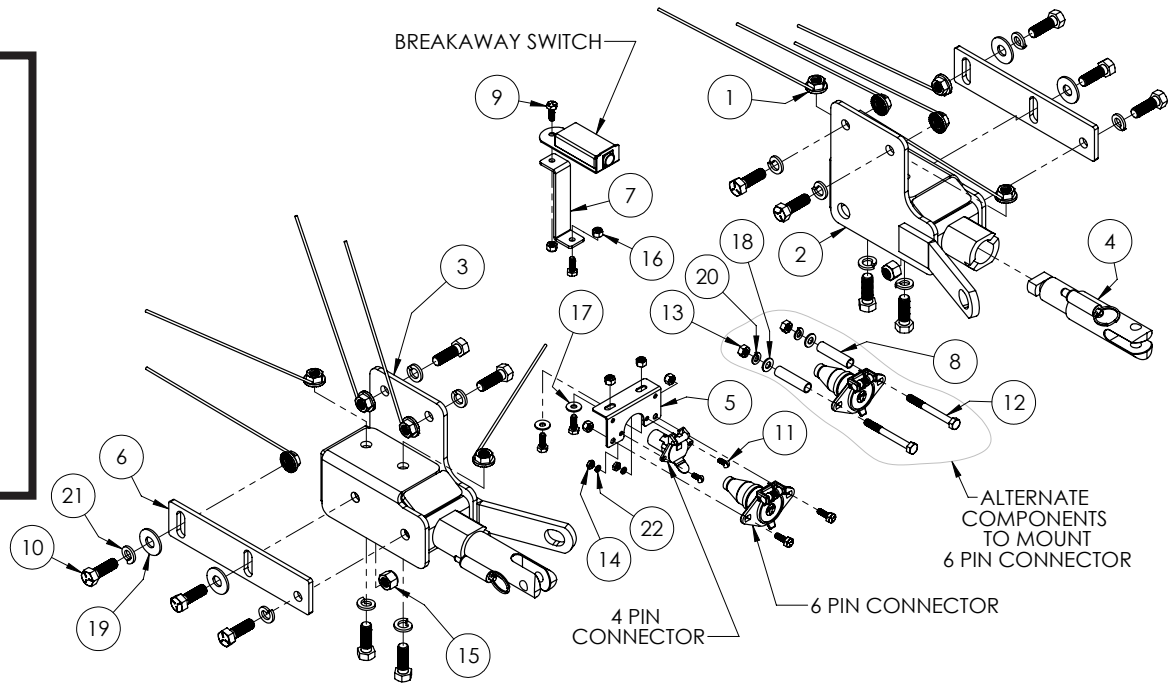

Item No.	Part No.	Description	Qty.
1.....	61-4029.....	1/2" Whiz Nut w/ 10" Wire .....	10
2.....	61-6591.....	BX1986 Baseplate, DS.....	1
3.....	61-6592.....	BX1986 Baseplate, PS.....	1
4.....	62-3468.....	Attachment Tab.....	2
5.....	101-6135.....	Electrical Bracket.....	1
6.....	102-6951.....	BX1986 Side Mount Plate .....	2
7.....	102-7116.....	BX1986 Breakaway Bracket.....	1
8.....	107-3077.....	1/2" OD Tubing x 2"L.....	2
9.....	201-0050.....	1/4"-20 x 3/4" Hex Head Bolt, Grade 5, ZP .....	6
10.....	201-0051.....	1/2"-13 x 1-1/2" Hex Head Bolt, Grade 5, ZP .....	14
11.....	201-0192.....	#10-32 x 1/2" Round Head Screw .....	2
12.....	201-0460.....	5/16"-18 x 3" Hex Head Bolt, Grade 5.....	2
13.....	202-0002.....	5/16"-18 Hex Nut, ZP.....	2
14.....	202-0047.....	#10-32 Hex Nut.....	2
15.....	202-0094.....	1/2"-13 Hex Nylon Lock Nut, ZP.....	2
16.....	202-0102.....	1/4"-20 Hex Nylon Lock Nut, ZP.....	6
17.....	203-0001.....	1/4" Flat Washer, ZP.....	2
18.....	203-0002.....	5/16" Flat Washer, ZP.....	2
19.....	203-0005.....	1/2" Flat Washer, ZP.....	4
20.....	203-0009.....	5/16" Lock Washer, ZP.....	2
21.....	203-0012.....	1/2" Lock Washer, ZP.....	12
22.....	203-0054.....	#10 Lock Washer.....	2
23.....	226-0049(not shown).....	Class IV Safety Cables.....	2
24.....	229-0512(not shown).....	1/2" Quicklink, ZP.....	2
25.....	290-0437(not shown).....	Black Cap Plug Receiver.....	2

#### **Important:**

Use only genuine factory replacement parts on your baseplate. Do NOT substitute homemade or non-typical parts. If a bolt is lost or in need of replacement, for your safety and the preservation of your baseplate, be sure to use a replacement bolt of the same grade (In most cases it will be Grade 5, please reference the parts list above). Replacement parts may be ordered through your nearest Blue Ox® Dealer or Distributor, or call our Customer Care Team at (402)385-3051. Failing to follow and/or altering these installation instructions in either installation or required equipment will void the manufacturer's warranty. Towing behind a non-motorized vehicle will void the warranty.



BX1986  
2009-17 Dodge Ram 1500 (No Sport)  
Installation Instructions

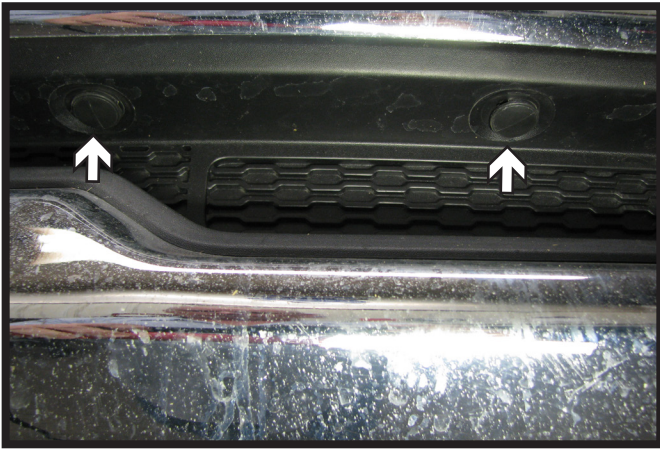

1. **2009-12 Models:** Remove the six (6) push pins along the front plastic insert and remove from the vehicle.

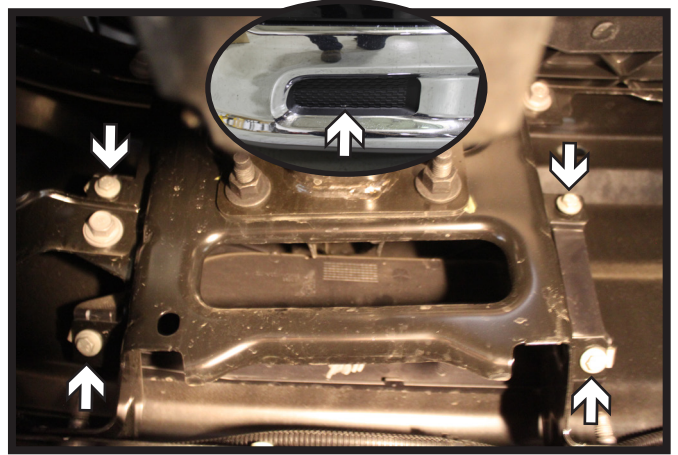

2. **2013 Models without Tow Hooks:** Using a 10MM socket, remove the four (4) screws from the bumper cover and slide out. Repeat on the other side of the vehicle. These covers will not be reinstalled.

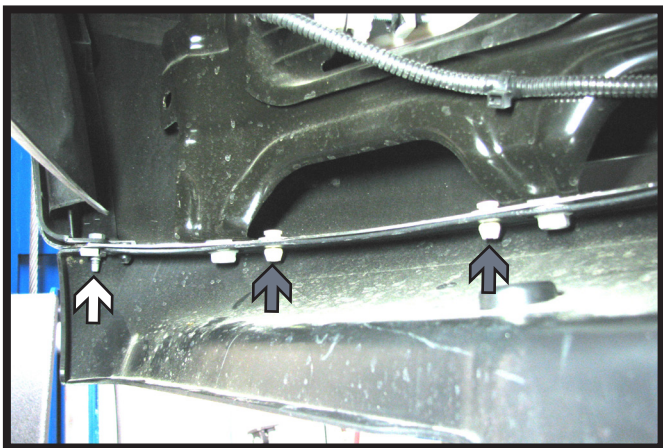

3. To remove the lower air dam, use a 10MM socket and remove the two (2) bolts in each corner of the air dam (white). Remove the thirteen (13) push pins along the seam (gray).

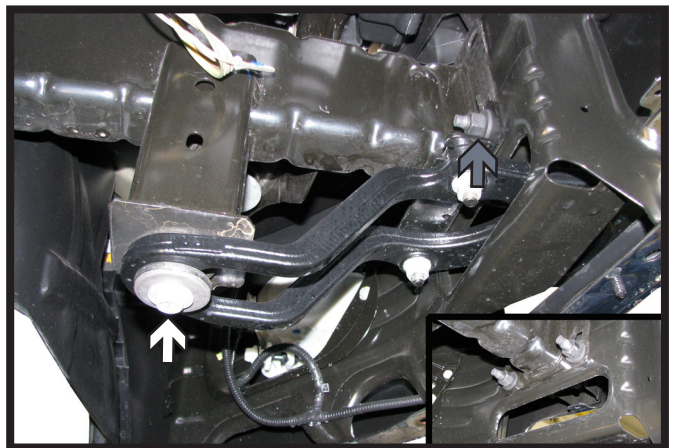

4. If equipped with tow hooks, use a 18MM socket to remove the lower bolt (white) and the two (2) upper nuts on either side of the frame (gray). Remove the tow hook and reinstall the upper nuts back onto the frame. Repeat on the other side of the vehicle.

BX1986  
2009-17 Dodge Ram 1500 (No Sport)  
Installation Instructions

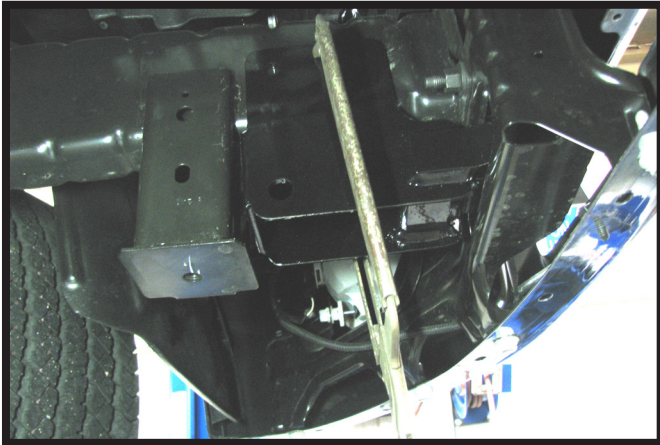

5. Tip the baseplate at an angle, then slide it into the opening and up to the frame. Clamp the baseplate to the frame.

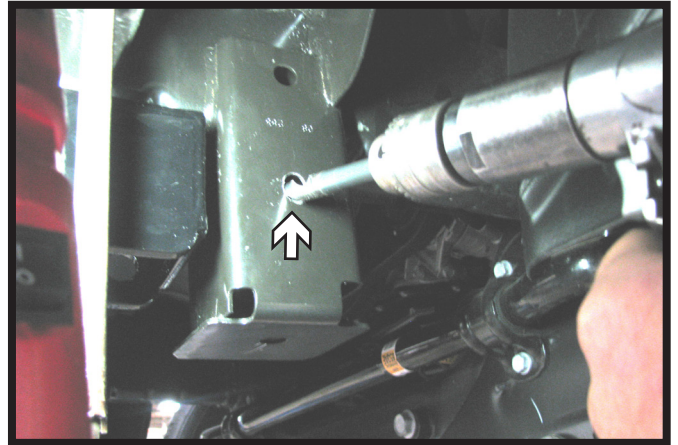

6. On the outer side of the frame, using a 17/32" drill bit, ream out the existing lower slot. Repeat on the other side of the vehicle.

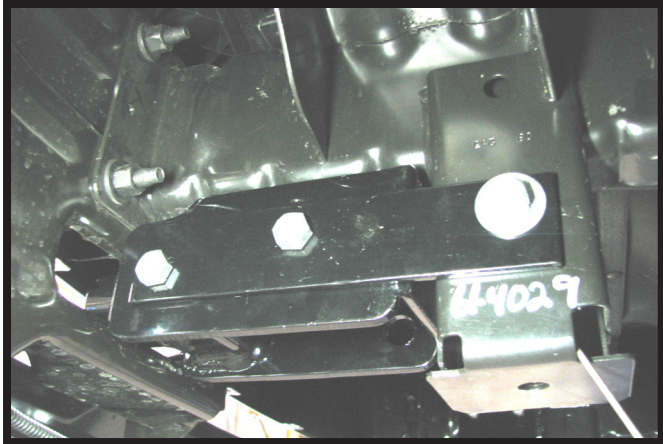

7. On the outer side of the frame install the sidemount plate with a 1/2"-13 x 1-1/2" bolt in the front hole, a 1/2"-13 x 1-1/2" bolt and 1/2" lock nut in the middle hole and a 1/2"-13 x 1-1/2" bolt and 1/2" nut wire in the rear hole. Tighten down the bolts and remove the clamp. DO NOT Loctite® the threads, this is a dryfit until all drilling is done. Repeat on the other side of the vehicle.

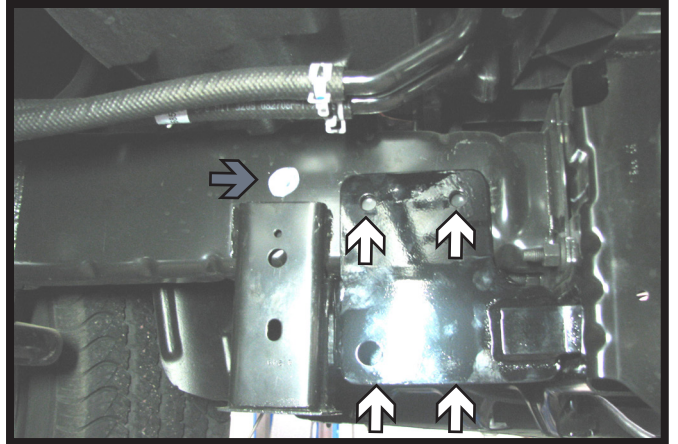

8. On the inner side of the frame, using the baseplate as a template, drill the two (2) upper frame holes and the two (2) bottom side frame holes with a 17/32" drill bit (white). Using a 1-1/4" hole saw, drill a hole in the frame above the bracket for access of the 1/2" nut wires (gray). Repeat on the other side of the vehicle.



BX1986  
2009-17 Dodge Ram 1500 (No Sport)  
Installation Instructions

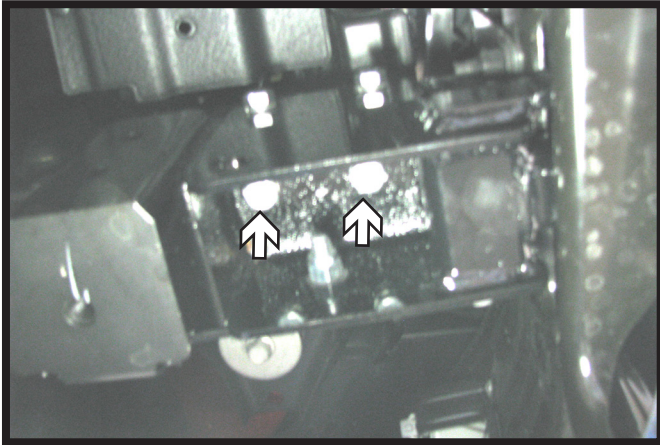

9. On the bottom frames holes, insert 1/2"-13 x 1-1/2" bolts with 1/2" lock washers and 1/2" nut wires and tighten down. Repeat on the other side of the vehicle.

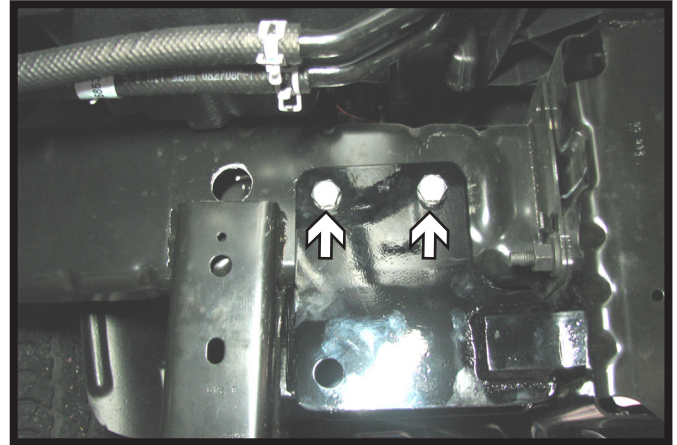

10. On the upper frame holes, insert 1/2"-13 x 1-1/2" bolts with 1/2" lock washers and 1/2" nut wires and tighten down. Repeat on the other side of the vehicle.

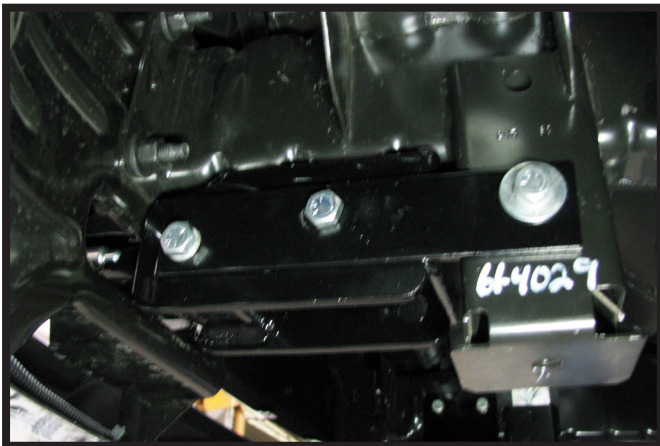

11. On the outer frame bolts, install 1/2" lock washers onto the front two (2) bolts. Then a 1/2" flat washer onto the rear hole. Fully tighten all bolts. Repeat on the other side of the vehicle.

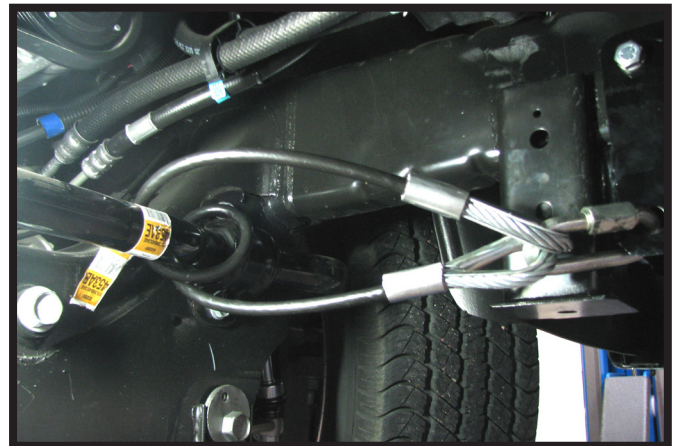

12. Attach the permanent baseplate safety cables to the provided convenience link on the baseplate. The photo above shows the recommended installation of the cables to frame of vehicle. Additional options may interfere with suggested mounting; in this case, secure the cables to a solid piece of the frame as described in the instructions included with the permanent baseplate safety cables. Be sure the safety cables do not rub against any hoses or moving parts. Do this on **BOTH** sides of the vehicle.

BX1986  
2009-17 Dodge Ram 1500 (No Sport)  
Installation Instructions

**2009-2012 Models Only**



13. Reinstall the lower plastic bumper. There are three holes in the plastic where the breakaway bracket can be attached using a 1/4-20 x 3/4" bolt with a 1/4-20 nut. Attach the breakaway to the top of the bracket also with a 1/4-20 x 3/4" bolt and a 1/4-20 nut.



14. On the lower air dam, measure 2" out from the second hole and cut apart. Do this on both sides. Reattach the lower air dam, the plastic bumper and reconnect the plug. If your vehicle is equipped with tow hooks, you will not need to trim the air dam.



15. Center the electrical connector and mark the location of the plastic insert. Using the 1-1/4" hole saw drill a hole. Drill two (2) 5/16" holes centered with the 1-1/4" hole to mount the electrical connector. The holes on the electrical connector will need to be reamed out.

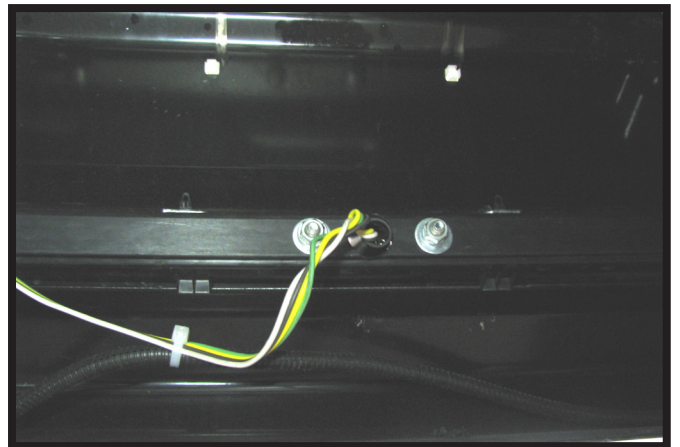

16. Attach the electrical connector with 5/16 x 3" bolts to 2" tubes, 5/16" flat washers and 5/16" nuts on the back side of the plastic insert.



BX1986  
2009-17 Dodge Ram 1500 (No Sport)  
Installation Instructions



17. **2013 Models:** Locate the electrical bracket to the desired location and mark the location of the bumper. Drill out attachment holes with a 1/4" drill bit. Install the bracket onto the bumper with 1/4" x 3/4" bolts and 1/4" lock nuts. Reinstall the air dam, mark for the electrical connector, then using the 1-1/4" hole saw drill a hole thru the air dam. Fasten the electrical connector to the bracket with 1/4" hardware.

## CUSTOMER SERVICE COMMITMENT

Blue Ox® is committed to providing you with exceptional customer care throughout your lifetime with our products. Our team is here to assist you with any questions you may have regarding the performance of your product. Simply call (402) 385-3051 and you can speak with our technical service team.

Additionally, please visit our website to see which rallies our Destination America team will be attending. For a nominal fee, our service technician will service your towing system to ensure it's in proper working condition. Also, as a commitment to our customers, should you visit our factory, you can stay at our full service Blue Ox® campground at no charge along with enjoying a factory tour.

Again, thank you for being our customer and for the confidence you have shown in the performance of our products. It is because of customers like you we enjoy the success we have today.

© 2015 Blue Ox  
One Mill Road, Industrial Park  
Pender, Nebraska 68047  
Phone: (402) 385-3051  
Fax: (402) 385-3360  
[www.blueox.com](http://www.blueox.com)



# General Information

1. Ensure that your product(s) are registered online at [www.blueox.com](http://www.blueox.com). It is crucial to register your product(s) so that you may be alerted of product offerings, updates, upgrades, maintenance and safety bulletins, and/or recalls.
2. **It is the owner's responsibility to inspect all towing equipment for cracked welds, missing or worn parts and loose bolts before each towing trip.** Be sure to use Loctite® Red on all bolts and tighten to the recommended specifications.
3. **It is the owner's responsibility to hook up all towing equipment per manufacturer's instructions/recommendations.**
4. Remove the attachment tabs when not in use (if applicable).

## Notice To Baseplate Installer

### 1. It is YOUR responsibility to watch for:

- Oil cooler and air conditioner lines
- Electrical wires and hoses
- Missing parts or attaching points on the frame

\*\* If the baseplate is improperly installed and is against a wire or hose, it could cause fluid leaks or electrical shorts some time after the actual baseplate installation.

## Permanent Baseplate Safety Cable Installation

Permanent baseplate safety cables are strongly recommended when towing a vehicle with a tow bar. The principle function of the permanent baseplate safety cables is to prevent the towed vehicle from breaking loose in the event the connection between the frame of the towed vehicle and the baseplate fails or becomes disconnected. The cables must be connected from the baseplate to the frame rail or cross member of the vehicle's frame. The illustrations below show the possible arrangements recommended by Blue Ox®. Each permanent baseplate safety cable must have an adequate weight rating for the towing system. The weight rating of the two (2) cables together will not qualify.

***Do not mount the permanent baseplate safety cables against wires, hoses or brake lines.***

These permanent baseplate safety cables should remain installed as long as the baseplate is installed on the vehicle. Permanent baseplate safety cables are to be used in conjunction with, and NOT a replacement for legally required safety cables attaching the towed vehicle to the towing vehicle.

### Option #1

(Baseplates with Convenience Link Tabs)

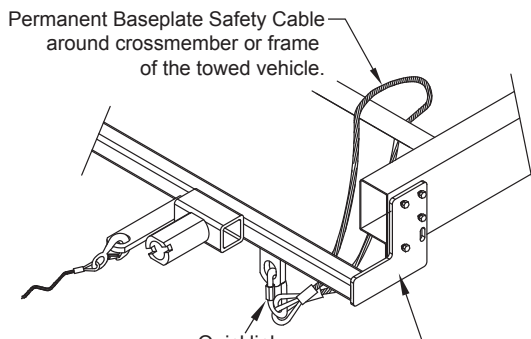

### Option #2

(Baseplates with out Convenience Link Tabs)

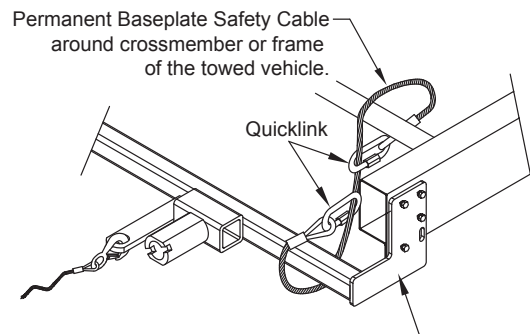

# BLUE OX ORIGINAL PURCHASERS THREE YEAR LIMITED WARRANTY

Automatic Equipment Manufacturing Company (“Automatic”) warrants to the original (first) retail purchaser that this product, manufactured by Automatic, shall be free from defect in material and workmanship under normal use and service for a period of three years from the date of delivery.

During said three-year period, Automatic will repair or replace any parts that have been returned by the original purchaser, to the factory, transportation prepaid, and in Automatic’s sole and absolute opinion found to be defective.

Limitations on Warranty Coverage:

Coverage under this warranty will be valid only if the customer warranty card is returned by the original purchaser within 30 days of purchase.

Coverage under this warranty will be effective only when a copy of the original invoice, showing date and place of purchase, accompanies any claim for warranty. This warranty is NON TRANSFERABLE.

This limited warranty will not cover, in any way or form, any alleged damages caused by incorrect or improper installation, improper use, modification or neglect of product, failure to properly service and maintain, misuse, act of God, accident or failure of the user to follow guidelines contained in the instructional material provided by Automatic.

This warranty does not cover normal wear and tear, paint or rust.

Warrantor assumes no responsibility to the owner for loss of use of product, loss of time, inconvenience or any other damage consequential or otherwise. Including, but not limited to mileage, expense of transporting of product, return shipping expense, mechanics travel time, telephone, road service, towing, and rental during repairs, travel, lodging, loss or damage to personal property or loss of earnings.

**REPAIR OR REPLACEMENT AS SET FORTH IN THIS LIMITED WARRANTY IS THE SOLE EXCLUSIVE REMEDY OF THE PURCHASER. AUTOMATIC SHALL NOT BE LIABLE FOR ANY INCIDENTAL OR CONSEQUENTIAL DAMAGES FOR BREACH OF ANY EXPRESS OR IMPLIED WARRANTY ON THIS PRODUCT. EXCEPT TO THE EXTENT PROHIBITED BY APPLICABLE LAW, ANY IMPLIED WARRANTY OF MERCHANTABILITY OR FITNESS FOR A PARTICULAR PURPOSE ON THIS PRODUCT IS LIMITED IN LENGTH TO THE DURATION OF THIS WARRANTY.**

Please visit <http://blueox.com/warranty/> to register your warranty

