



BX1994

2011-16 Chrysler Town & Country 2011-18 Dodge Grand Caravan Installation Instructions

Attachment Tab Height: 15"

Attachment Tab Width: 24"

Serial Number

Please read BOTH these Installation Instructions and the General Information sheet prior to installing or operating this equipment.

1. Blue Ox® towing products and accessories are intended to be installed by Blue Ox® Dealers who are familiar with our products and have the equipment and knowledge necessary to do "fit work". If needed, Blue Ox® Dealers can be found at www.blueox.com or by contacting our Technical Service Department at (402) 385-3051.
2. Many Blue Ox® baseplates are designed to use existing holes and hardware to mount the baseplate to the towed vehicle. Even though bolts are there, do not assume they are adequate for baseplate mounting. Always use the hardware supplied in the hardware kit and existing hardware as specified in the installation instructions.

Bolt Torque Specifications

Torque in Foot-Pounds for Inch Bolts

Bolt Size	Grade 5	Grade 8
1/4"	10	14
5/16"	19	29
3/8"	33	47
7/16"	54	78
1/2"	78	119
5/8"	154	230
3/4"	257	380

Bolt Torque Specifications

Torque in Foot-Pounds for Metric Bolts

Bolt Size	Grade 8.8	Grade 10.9
6MM	6	8
8MM	16	22
10MM	31	40
12MM	54	70
14MM	89	117
16MM	161	230
18MM	222	318



If the front of your vehicle looks different than this, please contact us at (402)385-3051.

Reference your vehicle owner's manual for manufacturer's towing specifications.



WARNING

Failure to read and follow these instructions could result in separation of the towed vehicle from the tow bar, causing property damage, loss of towed vehicle, personal injury or death.

BX1994
2011-16 Chrysler Town & Country
2011-18 Dodge Grand Caravan
Installation Instructions

Instruction Notes: The fascia, temperature sensor, ECM and windshield washer fluid reservoir are removed and reinstalled for the baseplate installation. Some drilling and trimming is required.

Place all components that are removed on a flat, sturdy surface. All items will be reinstalled unless otherwise noted after the baseplate is installed.

The dimensional variations between otherwise identical vehicles can be considerable. While the baseplate was designed for easy installation, it may be necessary to tailor the baseplate slightly to compensate for vehicle manufacturer's tolerances.

The BX8848 4-Diode Wiring Kit is recommended for this vehicle.

NOTICE

- Handling of some cosmetic parts when installing this product may require the use of protective covers, rags, specialty tools, etc. to prevent damage.
- When using power drills be aware of the dangers of torque and drill bit length.
- When using a reciprocating saw be aware of objects behind the cutting surface.
- Use a good quality paint to spray cut edges of frame to prevent rusting.
- Be sure that **ALL** electrical connections are plugged in and accessories are functioning properly before reinstalling the fascia.
- The baseplate is computer tested to your vehicle's GVWR, exceeding this weight will void the manufacturer's warranty.
- Be sure to use a sufficient amount of Loctite® Red on all bolt threads before tightening. Tighten all bolts according to the torque chart provided.
- Dealer or installer be certain the user receives these instruction sheets.
- If the baseplate is in an accident, it must be replaced. **DO NOT** use it again! An accident can cause unseen damage and using it again could result in more damage or serious injury. **DO NOT** use the baseplate if it is damaged or missing parts.

BX1994
2011-16 Chrysler Town & Country
2011-18 Dodge Grand Caravan
Installation Instructions

Tools Required

Large Vise Grip
Flat Screwdriver
Utility Knife
Phillips Screwdriver
Torque Wrench
Drill
Reciprocating Saw
Tape Measure
Loctite® RED
3/8" Drill Bit
10MM Socket
7/16" Socket
7/16" Wrench
9/16" Socket
9/16" Wrench

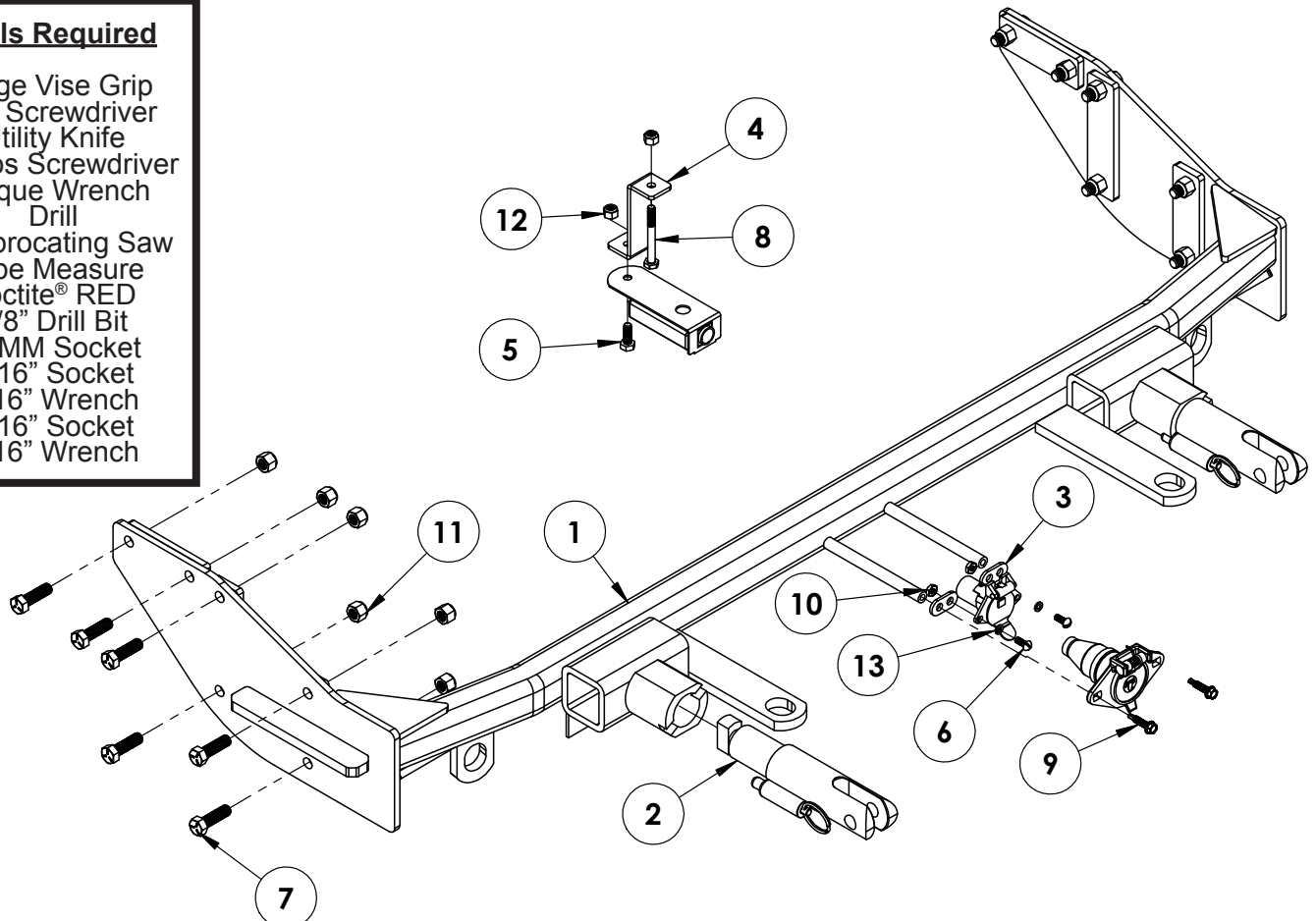

Item No.	Part No.	Description	Qty.
1.....	61-6857	BX1994 Baseplate.....	1
2.....	62-3468	Attachment Tab Assembly with Hole	2
3.....	101-5822	4 Way Connector Adapter	2
4.....	102-7168	Breakaway Bracket	1
5.....	201-0050	1/4"-20 x 3/4" Hex Head Bolt, Grade 5, ZP	1
6.....	201-0192	#10-32 1/2" Round Slotted Head Screw.....	2
7.....	201-0368	3/8"-16 x 1-1/4" Hex Head Bolt, Grade 5, ZP	12
8.....	201-0781	1/4"-20 x 2-1/4" Hex Head Bolt, Grade 5, ZP	1
9.....	201-0979	#12-14 x 1" Self Drilling Screw, ZP.....	2
10.....	202-0047	#10-32 Hex Nut	2
11.....	202-0090	3/8"-16 Hex Nylon Insert Lock Nut, ZP.....	12
12.....	202-0102	1/4"-20 Hex Nylon Nut, ZP	2
13.....	203-0054	#10 Lock Washer, ZP	2
14.....	226-0049(not shown)	Class IV Safety Cables.....	2
15.....	229-0512(not shown)	1/2" Quicklink, ZP	2
16.....	290-0437(not shown)	Black Cap Plug Receiver.....	2

Important:

Use only genuine factory replacement parts on your baseplate. Do **NOT** substitute homemade or non-typical parts. If a bolt is lost or in need of replacement, for your safety and the preservation of your baseplate, be sure to use a replacement bolt of the same grade (In most cases it will be Grade 5, please reference the parts list above). Replacement parts may be ordered through your nearest Blue Ox® Dealer or Distributor. Failing to follow and/or altering these installation instructions in either installation or required equipment will void the manufacturer's warranty. Towing behind a non-motorized vehicle will void the warranty.

BX1994
2011-16 Chrysler Town & Country
2011-18 Dodge Grand Caravan
Installation Instructions



1. Using a 10MM socket, remove the screw from the top edge of the fascia (white). Then remove the push pin just to the inside of the screw (gray). Do this on both sides of the vehicle.



2. Using a phillips screwdriver, remove the two (2) screws from along the edge of the wheel well. Do this on both sides of the vehicle.

3. Using a 10MM socket, remove the screw from the fascia/fender joint in the wheel well. Do this on both sides of the vehicle.



4. On the driver side only, remove the push pin in the inner wheel well.

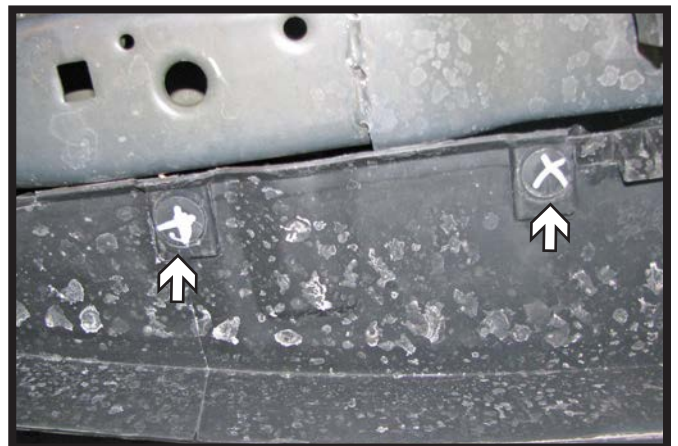

5. Remove the four (4) push pins from the underside of the fascia. There are two (2) on each side.

BX1994
2011-16 Chrysler Town & Country
2011-18 Dodge Grand Caravan
Installation Instructions



6. Disconnect the fog light and any other electrical connections. Pull the corners of the fascia away from the vehicle and set the fascia aside.



7. Trim the upper section of the shielding and remove the lower push pin. Do this on both sides of the vehicle.

8. Disconnect the temperature sensor from the bracket and move to a secure location until after baseplate installation.

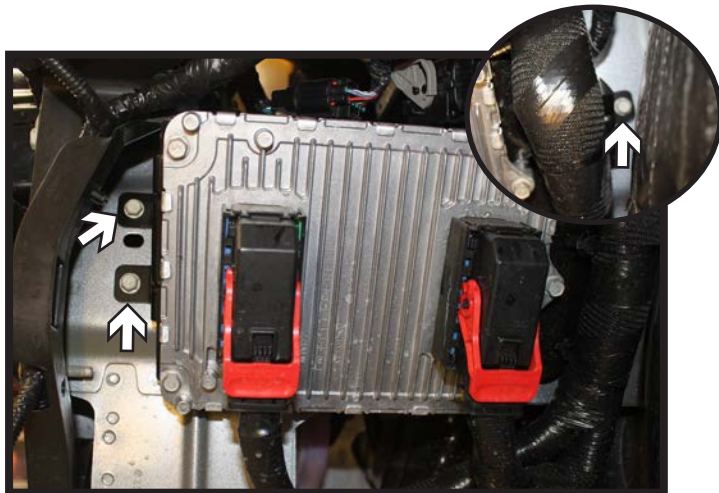
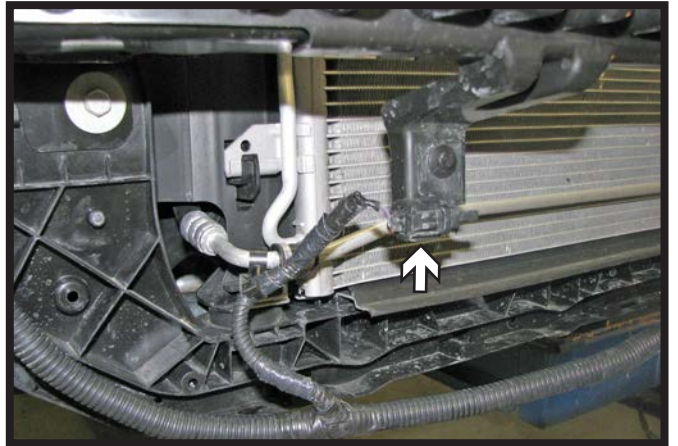

9. On the driver side, using a 10MM socket, remove the three (3) screws from ECM and set aside.

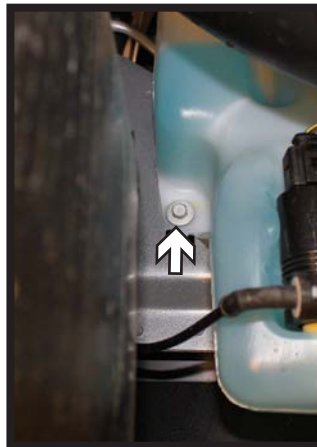

10. On the passenger side, using a 10MM socket, remove the two (2) screws from washer reservoir. Disconnect/plug all connections and set aside.

BX1994
2011-16 Chrysler Town & Country
2011-18 Dodge Grand Caravan
Installation Instructions

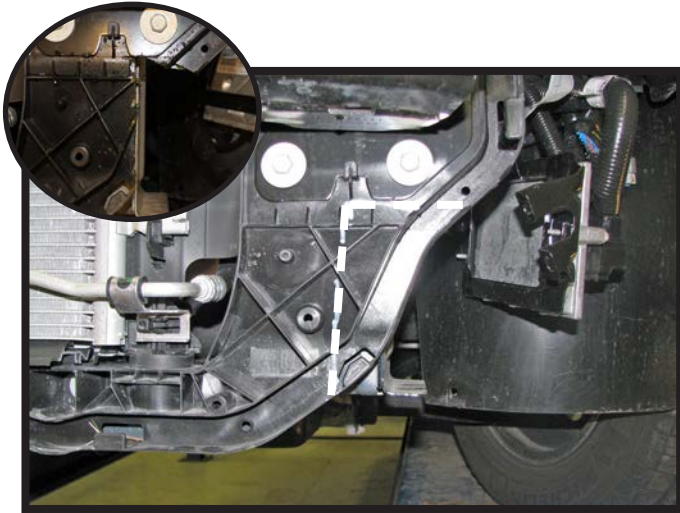

11. Trim the plastic shrouding across just under the metal plate back flush to the outside of the frame and down along the face of it. Do this on both sides of the vehicle.



12. Trim off the temperature sensor bracket and discard. The sensor will be relocated on the baseplate after installation.

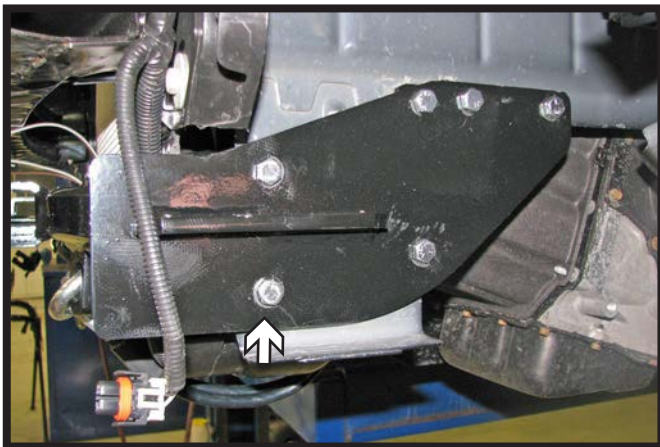

13. Position the baseplate onto the frame so the lower two (2) holes are centered on the lower structure and the upper three (3) holes are close to center on the frame lip. Level and clamp the baseplate into position. Using a 3/8" drill bit, drill the lower front hole thru the frame (white). Install the 3/8" hardware and fully tighten. Do this on both sides of the vehicle.

Continue drilling the remaining holes thru frame. Install the remaining 3/8" hardware and fully tighten all bolts.

**** Use Loctite® Red on all bolt threads and tighten all bolts to the appropriate torque.**

BX1994
2011-16 Chrysler Town & Country
2011-18 Dodge Grand Caravan
Installation Instructions



14. Attach the permanent baseplate safety cables to the provided convenience link on the baseplate. The photo above shows the recommended installation of the cables to frame of vehicle. Additional options may interfere with suggested mounting; in this case, secure the cables to a solid piece of the frame as described in the General Information sheet. Be sure the safety cables do not rub against any hoses or moving parts. Do this on **BOTH** sides of the vehicle.

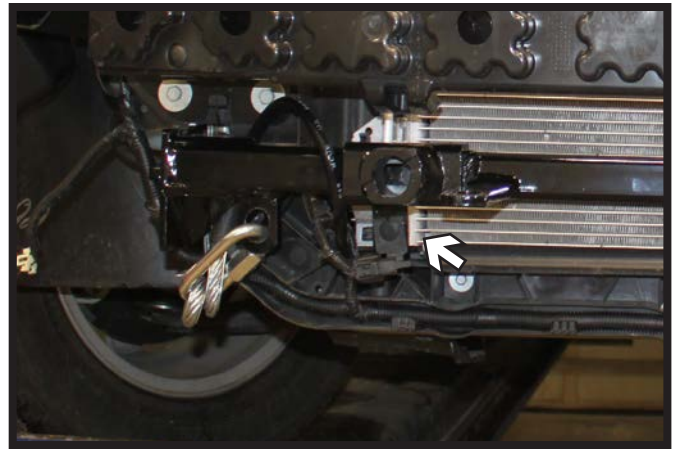

15. Reinstall the temperature sensor to the bracket on the baseplate.
Reinstall the washer reservoir and ECM.

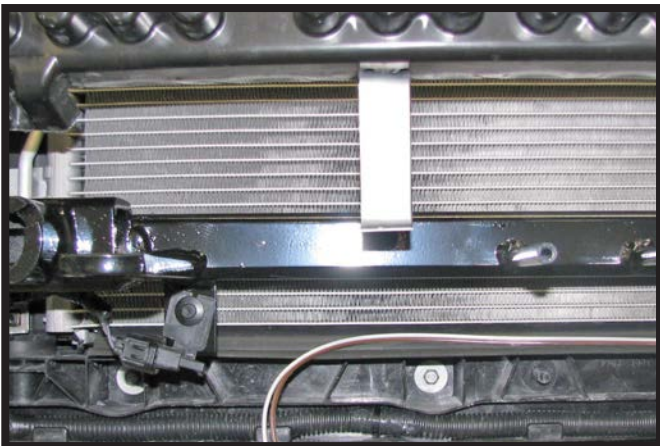

16. **Optional Breakaway:** Position the bracket in the desired location and drill a 1/4" hole thru the bumper and secure the bracket with the 1/4" x 2-1/4" bolt and lock nut. Attach the breakaway to the bracket with the 1/4" x 3/4" bolt and lock nut.



17. On the backside of the fascia, trim the corner as shown for baseplate clearance. Do this on both sides of the fascia.

BX1994
2011-16 Chrysler Town & Country
2011-18 Dodge Grand Caravan
Installation Instructions



18. Hold the fascia as close to its original position, mark and trim the fascia around the convenience links and attachment tabs. Reinstall the fascia.

CUSTOMER SERVICE COMMITMENT

Blue Ox® is committed to providing you with exceptional customer care throughout your lifetime with our products. Our team is here to assist you with any questions you may have regarding the performance of your product. Simply call (402) 385-3051 and you can speak with our technical service team.

Additionally, please visit our website to see which rallies our Destination America team will be attending. For a nominal fee, our service technician will service your towing system to ensure it's in proper working condition. Also, as a commitment to our customers, should you visit our factory, you can stay at our full service Blue Ox® campground at no charge along with enjoying a factory tour.

Again, thank you for being our customer and for the confidence you have shown in the performance of our products. It is because of customers like you we enjoy the success we have today.

© 2016 Blue Ox
One Mill Road, Industrial Park
Pender, Nebraska 68047
Phone: (402) 385-3051
Fax: (402) 385-3360
www.blueox.com

General Information

1. Ensure that your product(s) are registered online at www.blueox.com. It is crucial to register your product(s) so that you may be alerted of product offerings, updates, upgrades, maintenance and safety bulletins, and/or recalls.
2. **It is the owner's responsibility to inspect all towing equipment for cracked welds, missing or worn parts and loose bolts before each towing trip.** Be sure to use Loctite® Red on all bolts and tighten to the recommended specifications.
3. **It is the owner's responsibility to hook up all towing equipment per manufacturer's instructions/recommendations.**
4. Remove the attachment tabs when not in use (if applicable).

Notice To Baseplate Installer

1. It is YOUR responsibility to watch for:

- Oil cooler and air conditioner lines
- Electrical wires and hoses
- Missing parts or attaching points on the frame

** If the baseplate is improperly installed and is against a wire or hose, it could cause fluid leaks or electrical shorts some time after the actual baseplate installation.

Permanent Baseplate Safety Cable Installation

Permanent baseplate safety cables are strongly recommended when towing a vehicle with a tow bar. The principle function of the permanent baseplate safety cables is to prevent the towed vehicle from breaking loose in the event the connection between the frame of the towed vehicle and the baseplate fails or becomes disconnected. The cables must be connected from the baseplate to the frame rail or cross member of the vehicle's frame. The illustrations below show the possible arrangements recommended by Blue Ox®. Each permanent baseplate safety cable must have an adequate weight rating for the towing system. The weight rating of the two (2) cables together will not qualify.

Do not mount the permanent baseplate safety cables against wires, hoses or brake lines.

These permanent baseplate safety cables should remain installed as long as the baseplate is installed on the vehicle. Permanent baseplate safety cables are to be used in conjunction with, and NOT a replacement for legally required safety cables attaching the towed vehicle to the towing vehicle.

OPTION #1

Permanent Baseplate Safety Cables to Cross Member or Frame of Towed Vehicle.



OPTION #2

Permanent Baseplate Safety Cables to Cross Member or Frame of Towed Vehicle.

