

Serial Number

Please read **BOTH** these Installation Instructions and the General Towing Instructions before attempting to install or operate this equipment.

- Blue Ox® towing products and accessories are intended to be installed by Blue Ox® Dealers who are familiar with our products and have the equipment and knowledge to do “fit work”. When necessary, Blue Ox® Dealers can be found at www.blueox.com or by contacting our Customer Care Department at (402) 385-3051.
- Many Blue Ox® Baseplates are designed to use existing holes and hardware to mount the baseplate to the towed vehicle. Even though bolts are there, do not assume they are adequate for baseplate mounting. Always use hardware supplied in the hardware kit or existing hardware specified in the Baseplate Installation Instructions.

Attachment Tab Height: 13”
Attachment Tab Width: 20”

Bolt Torque Specifications
Torque in Foot-Pounds for Metric Bolts

Bolt Size	Grade 8.8	Grade 10.9
6MM	6	8
8MM	16	22
10MM	31	40
12MM	54	70
14MM	89	117

Confirm the towability and pre-towing procedures for your vehicle with the owner’s manual or contact the vehicle’s manufacturer for specific towing procedures.

Bolt Torque Specifications
Torque in Foot-Pounds for Inch Bolts

Bolt Size	Grade 5	Grade 8
1/4”	10	14
5/16”	19	29
3/8”	33	47
7/16”	54	78
1/2”	78	119
5/8”	154	230



If the front of your vehicle looks different than this, call us at (402) 385-3051.

⚠ WARNING

Failure to read and follow these instructions could result in separation of the towed vehicle from the tow bar, causing property damage, loss of towed vehicle, personal injury or death.

BX2199

2008-11 Ford Focus SES (Manual Transmission)

Installation Instructions

Parts List

Ref. No.	Qty.	Part #	Description
1	1	61-6474	WELDMENT, BASEPLATE, BX2199
2	8	201-0368	3/8-16 X 1 1/4 HEX HEAD BOLT,GRD. 5
3	8	203-0010	3/8 LOCK WASHER, ZP
4	8	202-0003	3/8-16 HEX NUT, ZP
5	1	201-0655	6MM-1.0 X 30MM HEX BOLT, GRD8.8,ZP
6	1	203-0161	6MM, LOCK WASHER, ZP
7	1	203-0001	1/4 FLAT WASHER, ZP
8	2	201-0553	1/4-20 X 1/2 HX.WSHD.TYPE F TCS, ZP
9	2	201-0192	10-32 X 1/2 SLOT, RD. HD. SCREW
10	2	203-0054	#10 LOCK WASHER
11	2	202-0047	#10-32 HEX NUT
12	2	101-5822	ADAPTER, 4 WAY CONNECTOR
13	2	62-3468	ATT TAB ASSY, REM, SF/SB, 1 HOLE
	2	226-0046	BASEPLATE SAFETY CABLE, 36" CL III (Not Shown)
	2	229-0359	QUICKLINK, 3/8, ZP (Not Shown)
	2	290-0437	RECEIVER, CAP PLUG (BLK), (Not Shown)

Tools Required

Loctite® RED
 6mm Socket
 7mm Socket
 8mm Socket
 10mm Socket
 7/16" Socket
 9/16" Socket
 13/32" Drill Bit
 30 Torx Socket
 Phillips Screwdriver
 Flat Screwdriver
 Vise Grips
 Utility Knife

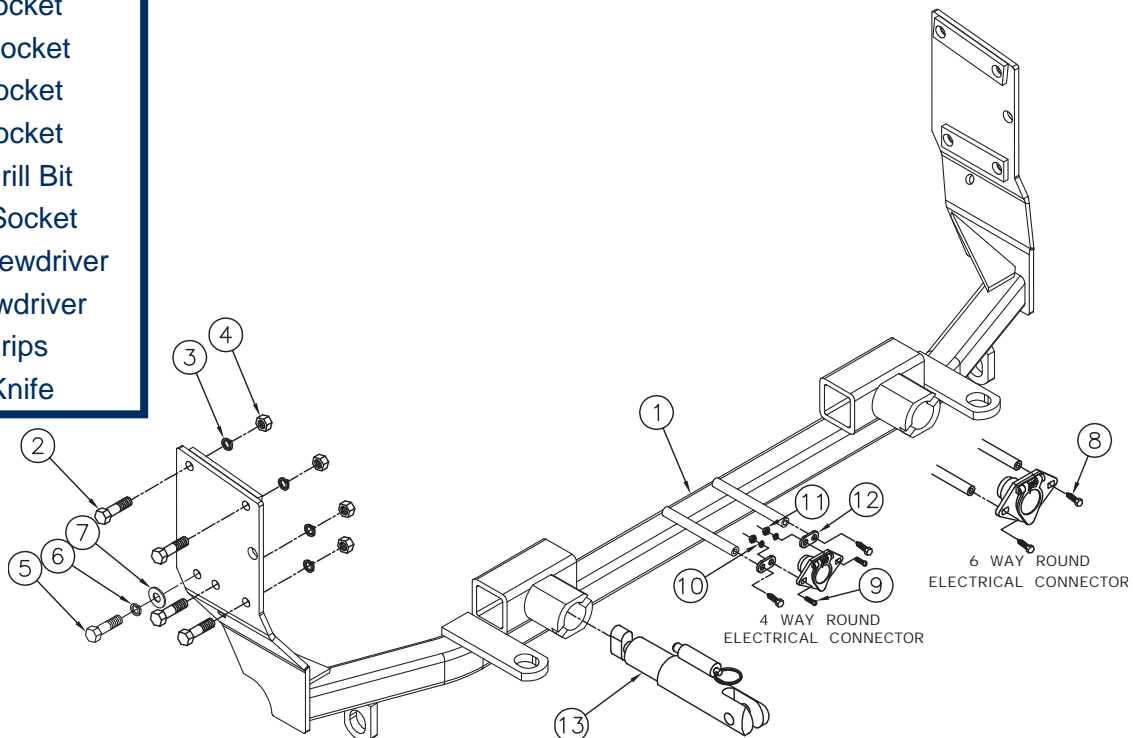

Important:

Use only genuine factory replacement parts on your baseplate. Do **NOT** substitute homemade or non-typical parts. If a bolt is lost or in need of replacement, for your safety and the preservation of your baseplate, be sure to use a replacement bolt of the same grade (In most cases it will be Grade 5, please reference the parts list above). Replacement parts may be ordered through your nearest Blue Ox® Dealer or Distributor. Failing to follow and/or altering these installation instructions in either installation or required equipment will void the manufacturer's warranty. Towing behind a non-motorized vehicle will void the warranty.

BX2199

2008-11 Ford Focus SES (Manual Transmission) Installation Instructions

Attachment Tabs:

Motorhome mount tow bars are recommended for use with this baseplate. Due to the design of the removable tabs, the RangeFinderII, Adventurer, and Ambassador tow bars can not be used. The Acclaim tow bar may be used, but will not fold and store on the front of the vehicle. Adapters, except the BX8833 and BX88151, can not be used with this baseplate.

Installation Notes: The radiator cover, grille assembly, headlights, fascia and air dams are removed for installation. Reinstallation of the air dams is optional. If air dams are reinstalled, trimming of the air dams is required. Drilling is required.

The dimensional variations between otherwise identical vehicles can be considerable. While the baseplate was designed for easy installation, it may be necessary to tailor the baseplate slightly to compensate for auto manufacturer's tolerances. These minor adjustments may include filing a hole slightly, bending electrical rods or bending end plates.

The BX8848 4-Diode Wiring Kit is recommended for this vehicle.

Handling of some cosmetic parts when installing this product may require the use of protective covers, rags, specialty tools, etc. to prevent damage.

Installation Instructions:



1. Remove four Phillips pushpins from radiator cover and lift to remove. Also remove grille assembly. Set pushpins, radiator cover and grille aside to be reinstalled later.



2. Using the 10mm socket, remove three screws from the headlight assembly, disconnect electrical and pull forward to remove. Do this to both sides of the vehicle. Set screws and headlight assemblies aside to be reinstalled later.

BX2199
2008-11 Ford Focus SES (Manual Transmission)
Installation Instructions

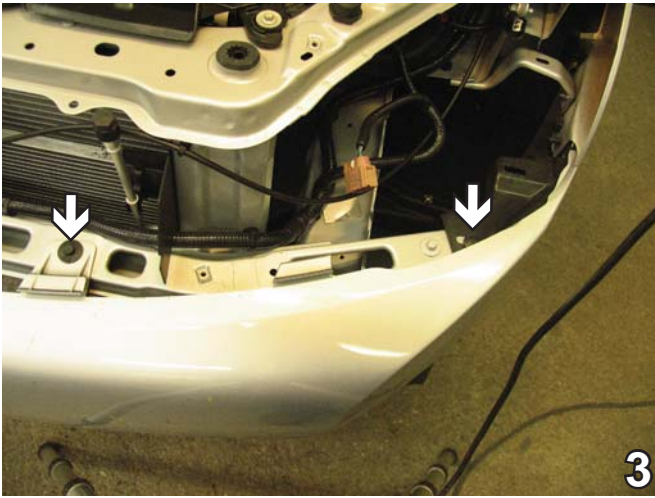

3. Remove two pushpins from upper corner of fascia. Do this to both sides of the vehicle. Set pushpins aside to be reinstalled later.



4. Using 6MM socket, remove one screw from edge of fascia, just inside the wheel well. Do this to both sides of the vehicle. Set screws aside to be reinstalled later.



5. Remove two pushpins from the wheel well using a flat screwdriver. Do this to both sides of the vehicle. Set pushpins aside to be reinstalled later.



6. Using the 7mm socket, remove two screw from the bottom corner of fascia. Do this to both sides of the vehicle. Set screws aside to be reinstalled later.

BX2199
2008-11 Ford Focus SES (Manual Transmission)
Installation Instructions

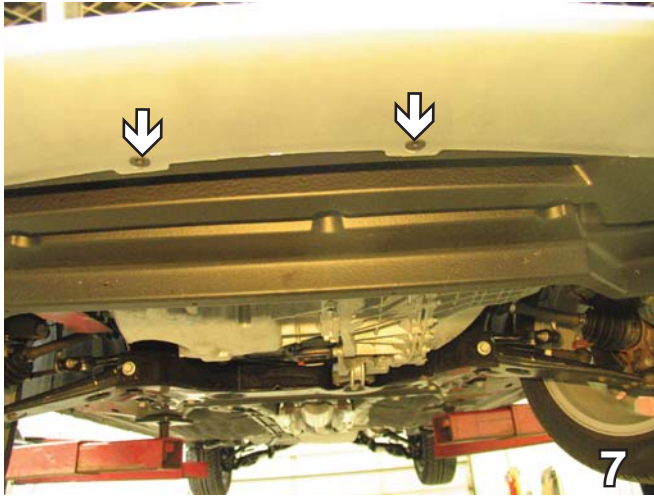

7. Using the 7MM socket, remove two screws from the bottom center of fascia. Set screws aside to be reinstalled later. Pull fascia corner out to the side of vehicle, both sides, then pull fascia forward and set aside carefully for later reinstallation. Unplug the fog lights.

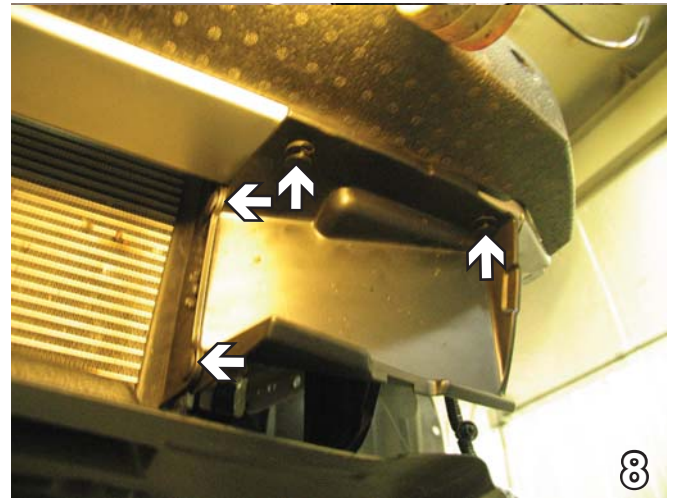

8. Using a flat screwdriver, remove four pushpins. Do this to both one sides of the vehicle. Remove the air dam. Set pushpins and air dam aside to be reinstalled later.

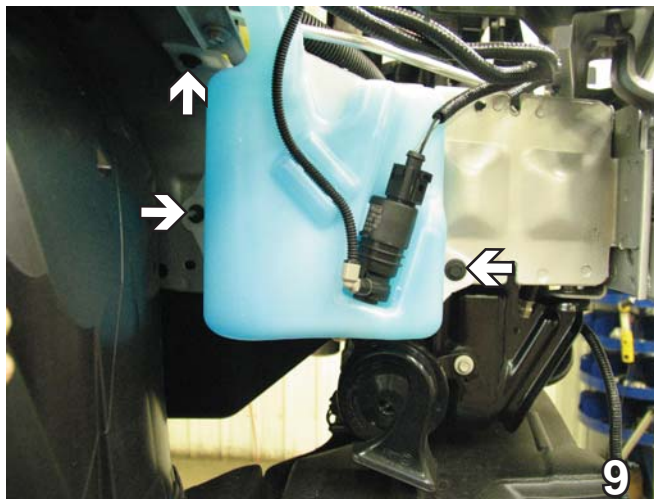

9. Using the 10mm socket, remove three metric bolts from the windshield washer tank. Set bolts and tank aside to be reinstalled later.



10. Using the 7MM socket, remove the screw from the wheel well. Set screw aside to be reinstalled later.

BX2199
2008-11 Ford Focus SES (Manual Transmission)
Installation Instructions

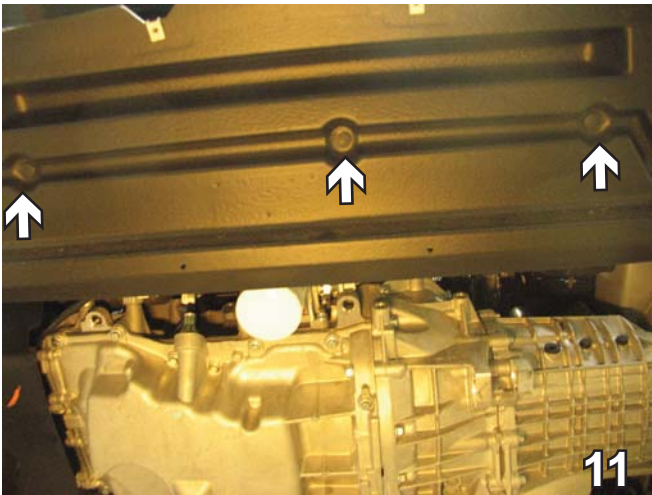

11. Using the flat screwdriver, remove three pushpins on the bottom and remove the black plastic piece. Set pushpins and plastic aside to be reinstalled later.

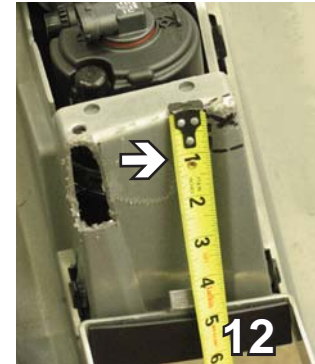
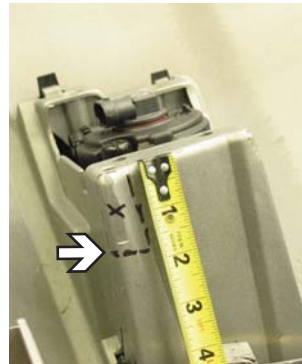

12. Using the utility knife, on the inside of the fascia trim the fog light housing bumps, on the bottom trim back 2" and on the top trim 1 1/2", flush with the plastic surface.

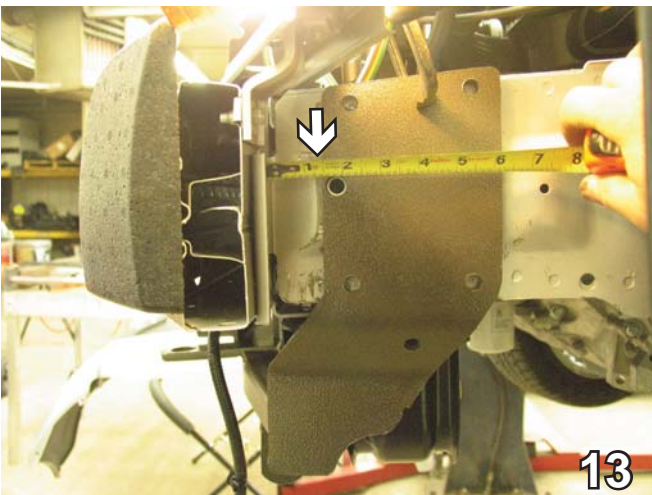

13. Slide the baseplate onto the frame rails 1 1/2" back from the bumper bracket aligning the front air baffle hole with the front middle hole of the baseplate. Align the top edge of the endplate with the top edge of the frame rail and clamp in place using the large vise grips. Hold the fascia up to its original position and verify the convenience links, electrical rods and attachment tabs come through the fascia opening.

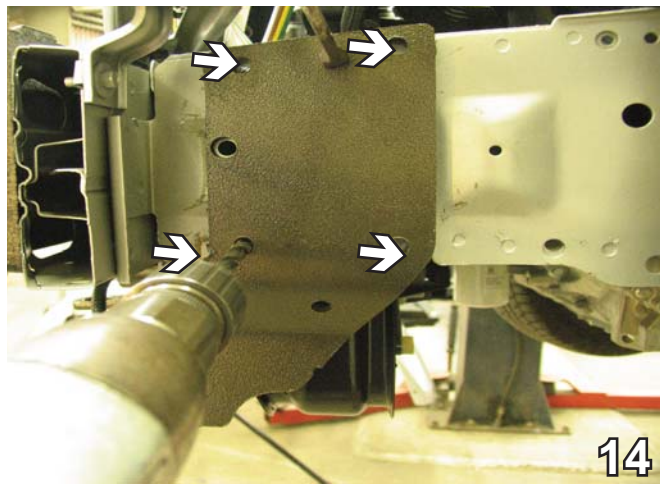

14. Using the baseplate as a template, drill four corner holes into the frame webbing with the 13/32" drill bit. Insert 3/8"-16 x 1 1/4" hex bolts into holes and tighten to the 1/4" lock washers and 3/8-16 hex nuts.

When using power drills be aware of the dangers of torque and drill bit length.

BE SURE TO USE LOCTITE® RED ON ALL BOLTS BEFORE TIGHTENING. TIGHTEN ALL BOLTS ACCORDING TO THE TORQUE CHART ON THE FRONT PAGE OF THESE INSTRUCTIONS OR ON PAGE 3 OF THE BASEPLATE TOWING GENERAL INSTRUCTIONS.

BX2199
2008-11 Ford Focus SES (Manual Transmission)
Installation Instructions

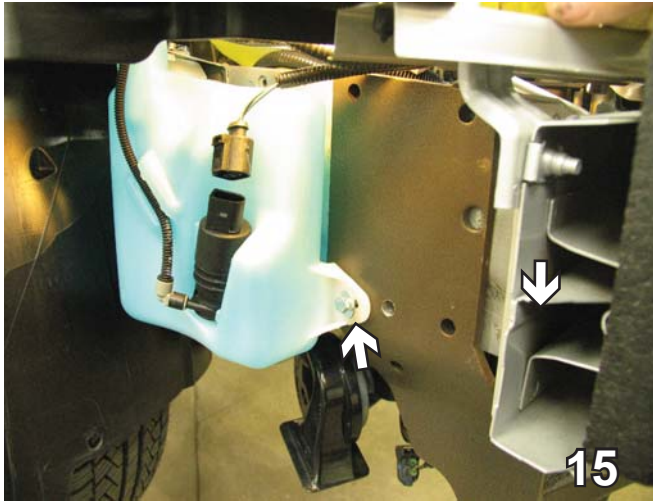

15. On the passenger side, do the same thing but there is an extra hole to reinstall the windshield washer tank in that hole use the longer 6MM bolt.



16 Trim the air dam, from the to edge take off 2 3/4". This allows clearance for the baseplate.

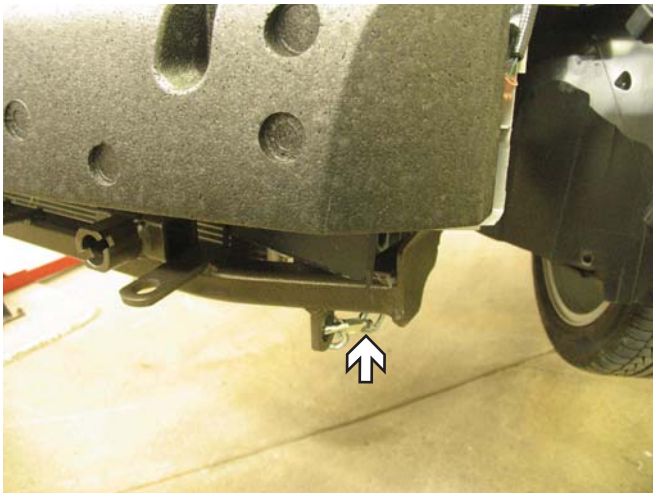

17. Attach the permanent baseplate safety cables to the provided convenience link on the baseplate (see grey arrow). The photo above shows the recommended installation of the cables to frame of vehicle (see white arrow). Additional options may interfere with suggested mounting; in this case secure the cables to a solid piece of the frame as described in the instructions included with the permanent baseplate safety cables. Be sure the safety cables do not rub against any hoses or moving parts. Do this to both sides of the vehicle.

Be sure that **ALL** electrical connections are plugged in properly and functioning **BEFORE** installing the fascia.

22. Reinstall air dams, fascia, headlights, grille assembly, radiator cover, pushpins, bolts and screws. *Note: Air dams may be left off vehicle or hold air dams just below original location and mark and trim the air dams to allow baseplate to fit.*

Install the tow bar and safety cables according to the instructions provided in their packages. When demonstrating this to the customer, be sure to include all the contents and packages.

Do **NOT** substitute other devices if the tow bar pins and clips are misplaced.

BX2199

2008-11 Ford Focus SES (Manual Transmission)

Installation Instructions



Shown without removable tabs installed.



Shown with removable tabs installed.

If the baseplate is in an accident, it must be replaced. **DO NOT** use it again! An accident can cause unseen damage and using it again could result in more damage or serious injury. **DO NOT** use the baseplate if it is damaged or missing parts.

DEALER or INSTALLER:
Be certain the user receives the instruction sheets for their products.

Customer Service Commitment

Blue Ox is committed to providing you with exceptional customer care throughout your lifetime with our products. Our team is here to assist you with any questions you may have regarding the performance of your product. Simply call 1-402-385-3051 and you can speak with our customer care team.

Additionally, please visit our website to see which rallies our Destination America team will be attending. For a nominal fee, our service technician will service your towing system to ensure it's in proper working condition. Also as a commitment to our customers, should you visit our factory you can stay at our full service Blue Ox campground at no charge along with enjoying a factory tour.

Again thank you for being our customer and for the confidence you have shown in the performance of our products. It is because of customers like you we enjoy the success we have today



© 2008, 09, 10 Blue Ox
One Mill Road, Industrial Park
Pender, Nebraska 68047
Phone: (402) 385-3051 • Fax: (402) 385-3360
www.blueox.com