



Strong As An Ox™

BX2233 Installation Instructions 1999-2004 Honda Odyssey

Serial No.

The fascia and metal bumper are removed for baseplate installation. Drilling is required. Trimming of fascia is required on the 2004 Model only. The BX8869 is available for the vehicle. Attachment Tabs are 22 inches center to center and a height of 13 1/2 inches.

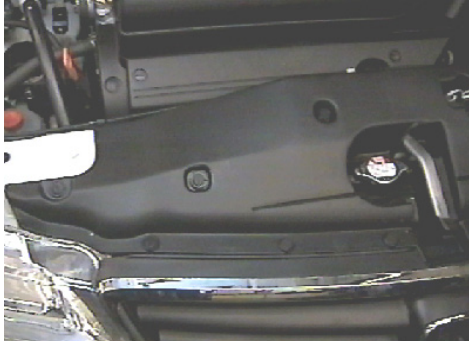

1. Remove the eleven push pins from black plastic cover on top side of fascia, lift cover and set aside.



2. Remove metric bolt from fascia's corner just inside wheel well edge with the 7MM socket, both sides.



3. Just forward of front tires is one metric bolt to remove with the 10MM socket, both sides.



4. Remove four push pins from the bottom of fascia's edge, pull fascia forward and set aside.

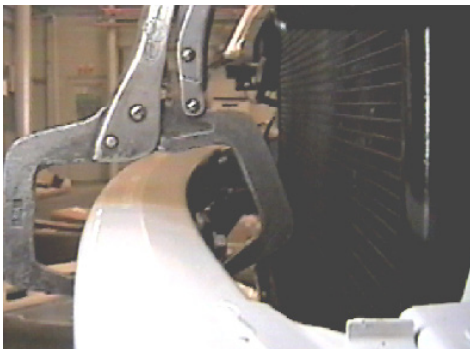

5. Slide baseplate up into place aligning end plates to the outside of frame and clamp the upright supports to the back of the metal bumper, with the vise grips. Mark all holes on frame ends and the back of metal bumper.

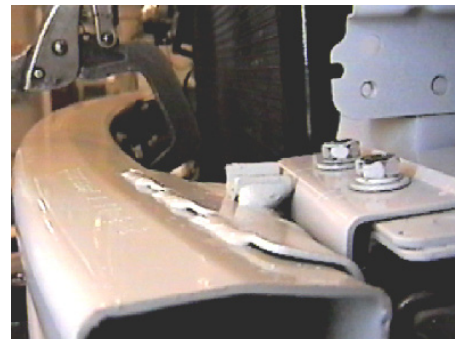

6. Using the 10MM socket, remove two metric bolts from bumper bracket on the top side of frame and one metric bolt from the bottom side, both sides and pull metal bumper forward and set aside.



Strong As An Ox™

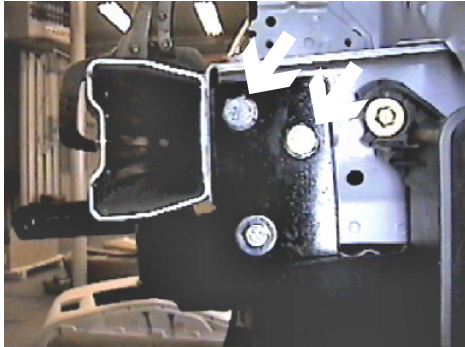

7. Drill the top holes in frame end with the 17/32" Drill bit, both sides. Align baseplate with drill holes, insert double nut plate into frame end to align with drilled holes and tighten 1/2" bolts and lock washers, both sides. **Be sure and use loctite on all bolts before tightening. Tighten all bolts according to torque chart in the General Instruction sheet.**

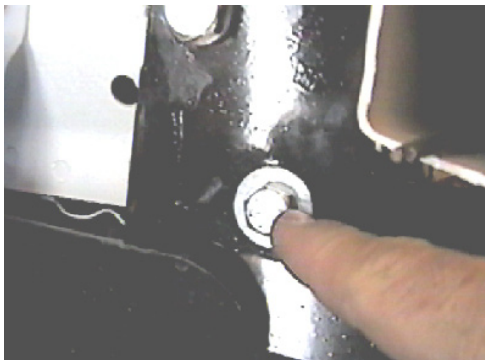

9. Using the baseplate as a template, drill the lower hole on the frame end webbing with the 13/32" drill bit, both sides. Insert 3/8" bolt into drilled hole and tighten 3/8" hex nut with lock washer. **Be sure and use loctite on all bolts before tightening. Tighten all bolts according to torque chart in the General Instruction sheet.**



8. Drill the four holes in back side of metal bumper with the 13/32" Drill bit. Reinstall metal bumper. Insert 3/8" nut plate into end of metal bumper to align with drill holes, tighten 3/8" bolts with lock washers through upright supports. **Be sure and use loctite on all bolts before tightening. Tighten all bolts according to torque chart in the General Instruction sheet.**

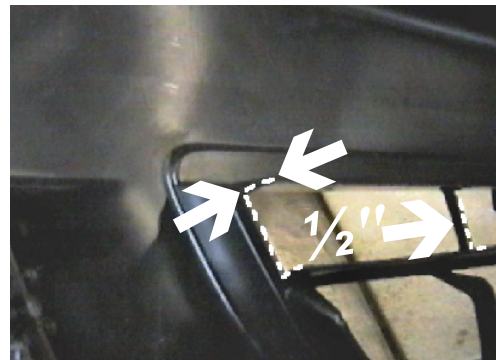

10. Reinstall fascia. **2004 Model:** Put fascia face down on a soft surface to prevent scratching. Trim the end of upper opening end 1 inch toward the front of fascia as shown in photo above, both sides. The end passenger's side upper opening is enclosed on the back and will need to be removed as shown in photo below step 9. Remove 1/2" of fascia off the back side of vertical styles in upper opening as shown in the photo above. The center vertical style may not need to be trimmed. Hold fascia in place to assure proper trimming and reinstall.



Strong As An Ox™

11. The dimensional variations between otherwise identical cars can be considerable. While the location and size of the holes in the baseplate were designed to allow for easy installation, it may be necessary to file a hole slightly to allow a bolt to clear.
12. Install the tow bar and safety cables according to the instructions included in their packages.
13. Do **not** substitute other devices if the tow bar pin and clip are lost.
14. **DEALER OR INSTALLER: BE CERTAIN THE USER RECEIVES THE INSTRUCTION SHEET.**

*Location for the
Bx8869 on driver's side
tail light assembly.*

Page 3 of 4



Tools Required

7MM Socket
10MM Socket
Utility Knife

Vise Grips
Loctite
13/32" Drill Bit

9/16" Socket
3/4" Socket
17/32" Drill Bit



Strong As An Ox™

Parts List

Ref. No.	Qty.	Part No.	Description
1	1	61-5971	Weldment, Base Plate, BX2233
2	1	61-5288	Driver Side 1/2" Nut Plate
3	1	61-5289	Passenger Side 1/2" Nut Plate
4	4	61-5208	3/8" Nut Plate, with Wire
5	4	201-0051	1/2-13 x 1 1/2 Bolt, Grd. 5, ZP
6	4	203-0012	1/2 Lock Washer, ZP
7	6	201-0368	3/8-16 x 1 1/4 Bolt, Grd. 5, ZP
8	6	203-0010	3/8 Lock Washer, ZP
9	2	202-0003	3/8-16 Hex Nut
10	2	201-0979	#12-14 x 1" Self Drilling Screw, ZP
11	2	201-0192	#10-32 x 1/2 Slot, Rd. Hd. Screw
12	2	203-0054	#10 Lock Washer
13	2	202-0047	#10-32 Hex Nut
14	2	101-5822	Adapter, 4 Way Connector
	2	226-0046	Baseplate Safety Cable, 36" CL III (Not Shown)
	4	229-0359	Quicklink, 3/8, ZP (Not Shown)

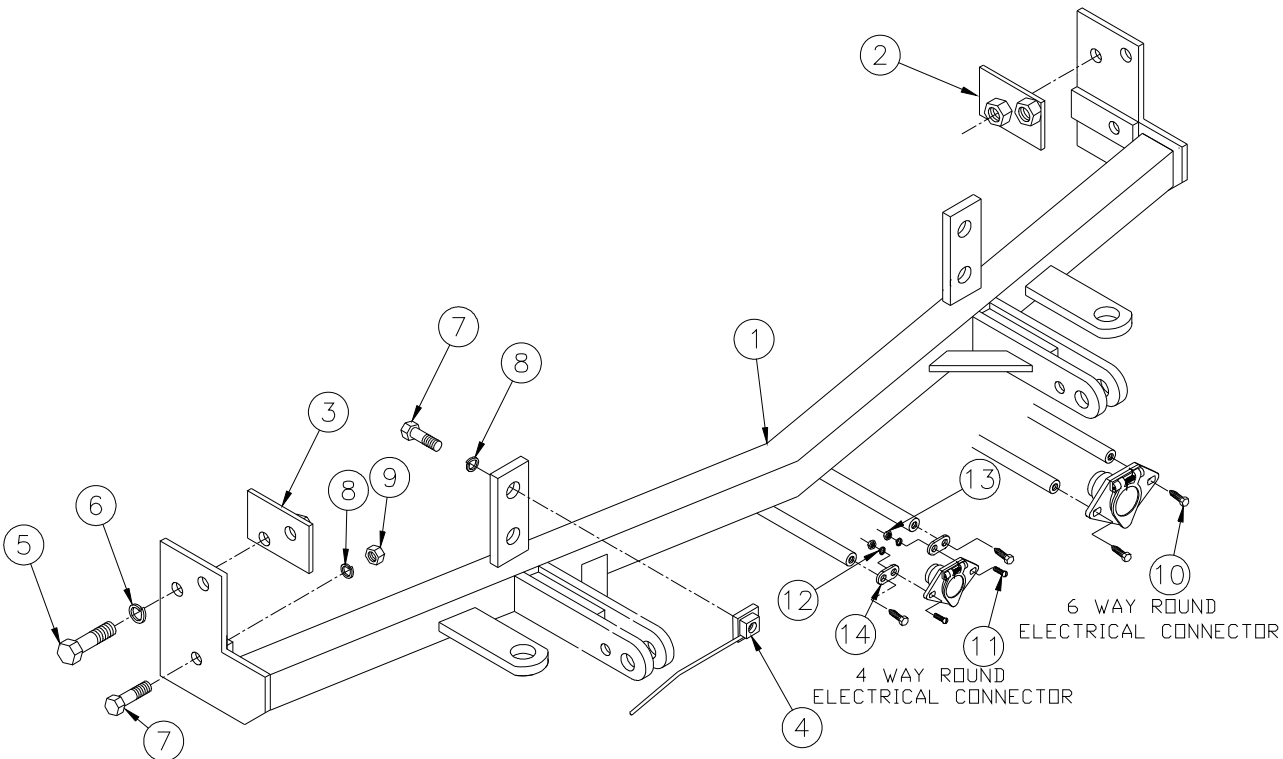

IMPORTANT: Use only genuine factory replacement parts on your Base Plate. Do not substitute homemade or nontypical parts. If a bolt is lost or in need of replacement, for your safety and the preservation of your Base Plate, be sure to use a replacement bolt of the same grade (Usually Grade 5, refer to parts list). Repair parts may be ordered through your nearest **Blue Ox** dealer or distributor.