



# BX2263 2016 Honda Pilot Installation Instructions

Attachment Tab Height: 17"

Attachment Tab Width: 24"

Serial Number

Please read BOTH these Installation Instructions and the General Instructions prior to installing or operating this equipment.

- Blue Ox® towing products and accessories are intended to be installed by Blue Ox® Dealers who are familiar with our products and have the equipment and knowledge necessary to do "fit work". If needed, Blue Ox® Dealers can be found at [www.blueox.com](http://www.blueox.com) or by contacting our Customer Care Department at (402) 385-3051.
- Many Blue Ox® baseplates are designed to use existing holes and hardware to mount the baseplate to the towed vehicle. Even though bolts are there, do not assume they are adequate for baseplate mounting. Always use the hardware supplied in the hardware kit and existing hardware as specified in the installation instructions.



If the front of your vehicle looks different than this, please contact us at (402)385-3051.

**Reference your vehicle owner's manual for manufacturer's towing specifications.**

### Bolt Torque Specifications

Torque in Foot-Pounds for Inch Bolts

Bolt Size	Grade 5	Grade 8
1/4"	10	14
5/16"	19	29
3/8"	33	47
7/16"	54	78
1/2"	78	119
5/8"	154	230
3/4"	257	380

### Bolt Torque Specifications

Torque in Foot-Pounds for Metric Bolts

Bolt Size	Grade 8.8	Grade 10.9
6MM	6	8
8MM	16	22
10MM	31	40
12MM	54	70
14MM	89	117
16MM	161	230
18MM	222	318



## WARNING

Failure to read and follow these instructions could result in separation of the towed vehicle from the tow bar, causing property damage, loss of towed vehicle, personal injury or death.

BX2263  
2016 Honda Pilot  
Installation Instructions

**Instruction Notes:** The fascia cover, fascia, windshield washer fluid reservoir, PS headlight are removed and reinstalled for the baseplate installation. Some drilling and trimming is required.

Place all components that are removed on a flat, sturdy surface. All items will be reinstalled unless otherwise noted after the baseplate is installed.

The dimensional variations between otherwise identical vehicles can be considerable. While the baseplate was designed for easy installation, it may be necessary to tailor the baseplate slightly to compensate for vehicle manufacturer's tolerances.

The BX8848 4-Diode Wiring Kit is recommended for this vehicle.

## ***NOTICE***

- Handling of some cosmetic parts when installing this product may require the use of protective covers, rags, specialty tools, etc. to prevent damage.
- When using power drills be aware of the dangers of torque and drill bit length.
- When using a reciprocating saw be aware of objects behind the cutting surface.
- Use a good quality paint to spray cut edges of frame to prevent rusting.
- Be sure that **ALL** electrical connections are plugged in and accessories are functioning properly before reinstalling the fascia.
- The baseplate is computer tested to your vehicle's GVWR, exceeding this weight will void the manufacturer's warranty.
- Be sure to use a sufficient amount of Loctite® Red on all bolt threads before tightening. Tighten all bolts according to the torque chart provided.
- Dealer or installer be certain the user receives these instruction sheets.
- If the baseplate is in an accident, it must be replaced. **DO NOT** use it again! An accident can cause unseen damage and using it again could result in more damage or serious injury. **DO NOT** use the baseplate if it is damaged or missing parts.

# BX2263 2016 Honda Pilot Installation Instructions

## Tools Required

Flat Screwdriver  
Utility Knife  
Phillips Screwdriver  
Torque Wrench  
Loctite® RED  
10MM Socket  
12MM Socket  
13MM Socket  
14MM Socket  
14MM Wrench  
7/16" Socket  
7/16" Wrench  
1-1/8" Socket

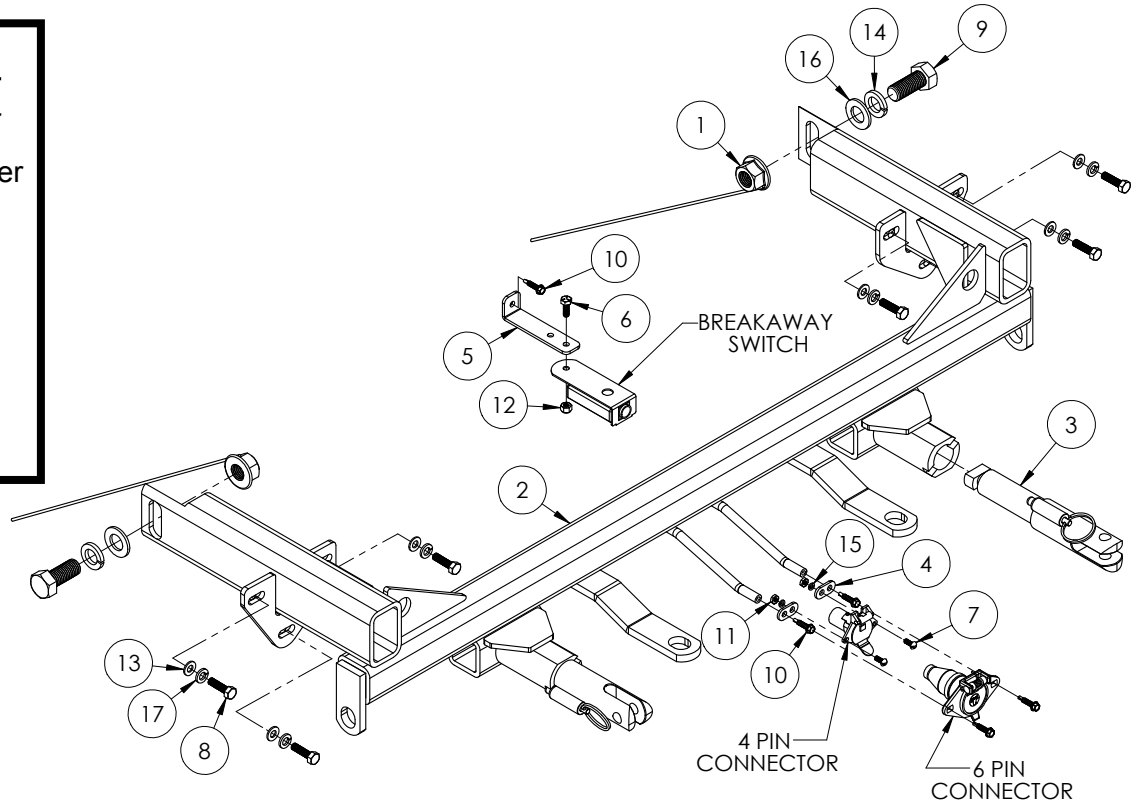

Item No.	Part No.	Description	Qty.
1	61-6859	3/4"-10 Whiz Nut w/ 18" Wire	2
2	61-7531	BX2263 Baseplate	1
3	62-3469	Attachment Tab Assembly with Hole	2
4	101-5822	4 Way Connector Adapter	2
5	102-7186	Breakaway Bracket	1
6	201-0050	1/4"-20 x 3/4" Hex Head Bolt, Grade 5, ZP	1
7	201-0192	#10-32 1/2" Round Slotted Head Screw	2
8	201-0446	8MM-1.25 x 30MM Hex Head Bolt, Grade 8.8, ZP	6
9	201-0514	3/4"-10 x 1-3/4" Hex Head Bolt, Grade 5, ZP	2
10	201-0979	#12-14 x 1" Self Drilling Screw, ZP	3
11	202-0047	#10-32 Hex Nut	2
12	202-0102	1/4"-20 Hex Nylon Nut, ZP	1
13	203-0002	5/16" Flat Washer, ZP	6
14	203-0014	3/4" Lock Washer, ZP	2
15	203-0054	#10 Lock Washer, ZP	2
16	203-0064	3/4" Flat Washer, ZP	2
17	203-0102	8MM Lock Washer, ZP	6
18	226-0049(not shown)	Class IV Safety Cables	2
19	229-0512(not shown)	1/2" Quicklink, ZP	2
20	290-0437(not shown)	Black Cap Plug Receiver	2

## **Important:**

Use only genuine factory replacement parts on your baseplate. Do **NOT** substitute homemade or non-typical parts. If a bolt is lost or in need of replacement, for your safety and the preservation of your baseplate, be sure to use a replacement bolt of the same grade (In most cases it will be Grade 5, please reference the parts list above). Replacement parts may be ordered through your nearest Blue Ox® Dealer or Distributor. Failing to follow and/or altering these installation instructions in either installation or required equipment will void the manufacturer's warranty. Towing behind a non-motorized vehicle will void the warranty.

BX2263  
2016 Honda Pilot  
Installation Instructions



1. Unsnap the fascia cover from the vehicle and set aside.



2. Remove the four (4) screws from the intake tube and set aside.

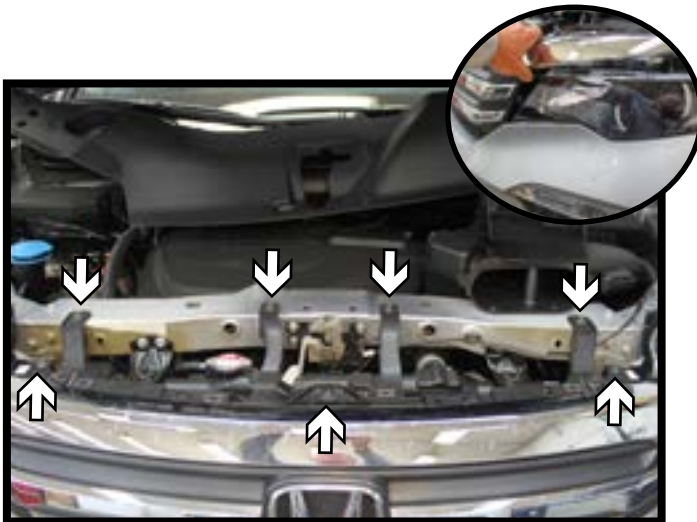

3. Using a 10MM socket, remove the seven (7) screws from the top edge of the fascia. Unsnap the upper portion of the fascia along the headlights from the vehicle.

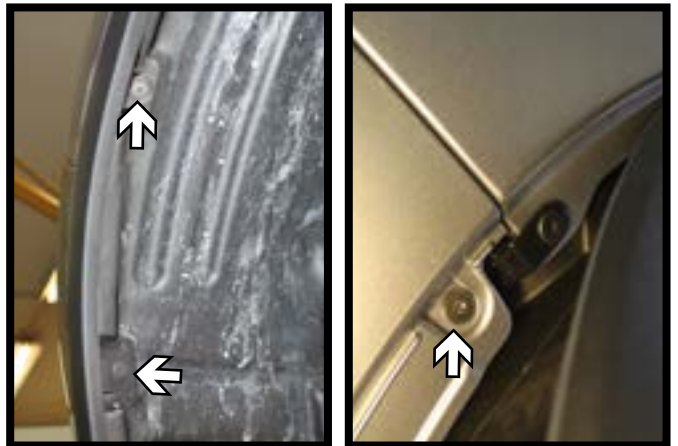

4. Using a phillips screwdriver, remove the three (3) screws from the edge of the wheel well (left). The upper two screws are shown the third screw is below. Pull back the fender flare and remove the screw at the fascia joint (right). Do this on both sides of the vehicle.

BX2263  
2016 Honda Pilot  
Installation Instructions

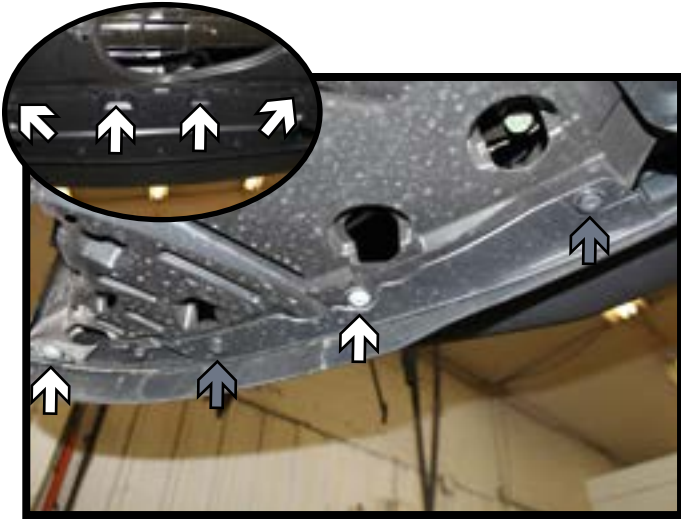

5. Using a 10MM socket, remove the eight (8) screws from the underside of the fascia. There are two (2) in each corner and four (4) in the middle (white).

Remove the four (4) push pins. There are two (2) on each side (gray).

Pull the corners of the fascia away from the vehicle disconnecting any electrical connections and set the fascia aside.

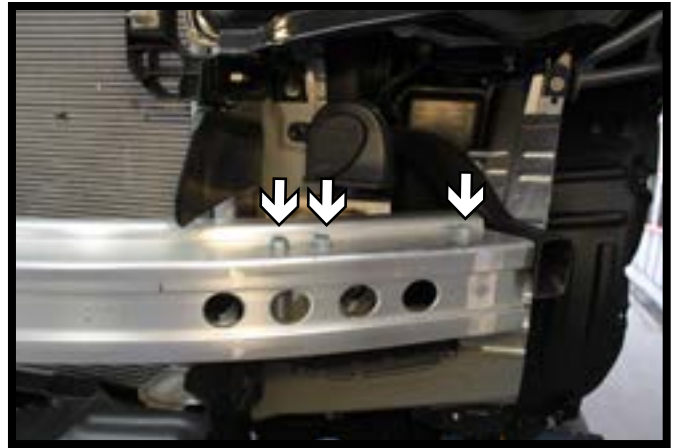

6. Using a 14MM socket, remove the six (6) bolts from the bumper. There are three (3) on each side. Set the bumper aside it will not be reinstalled.

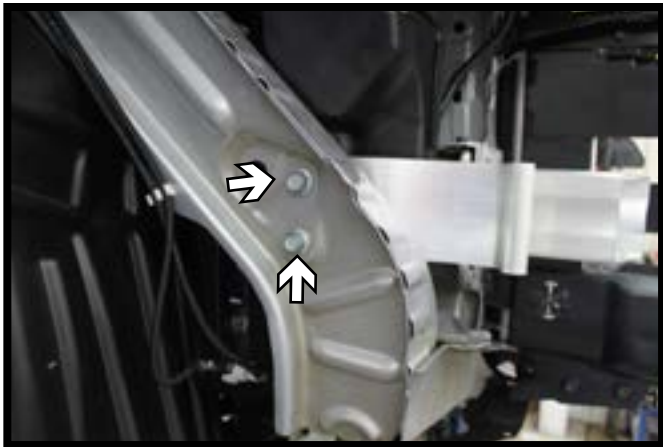

7. Using a 14MM socket, remove the two (2) bolts from the frame braces. Do this on both sides of the vehicle. The braces will not be reinstalled.

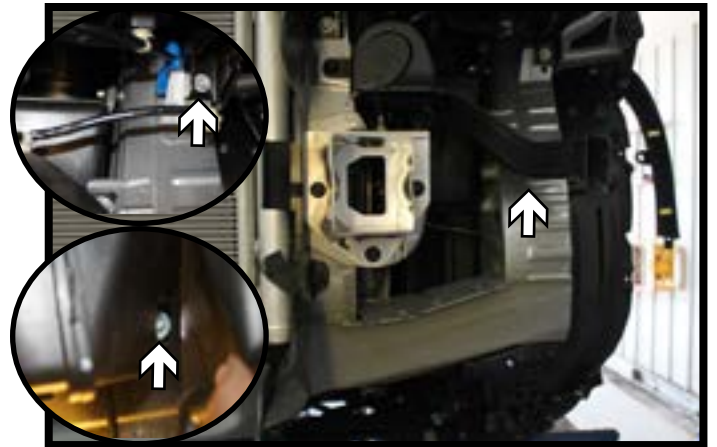

8. On the driver side, using a 10MM socket, remove the two (2) screws from the air baffle and set aside.

BX2263  
2016 Honda Pilot  
Installation Instructions

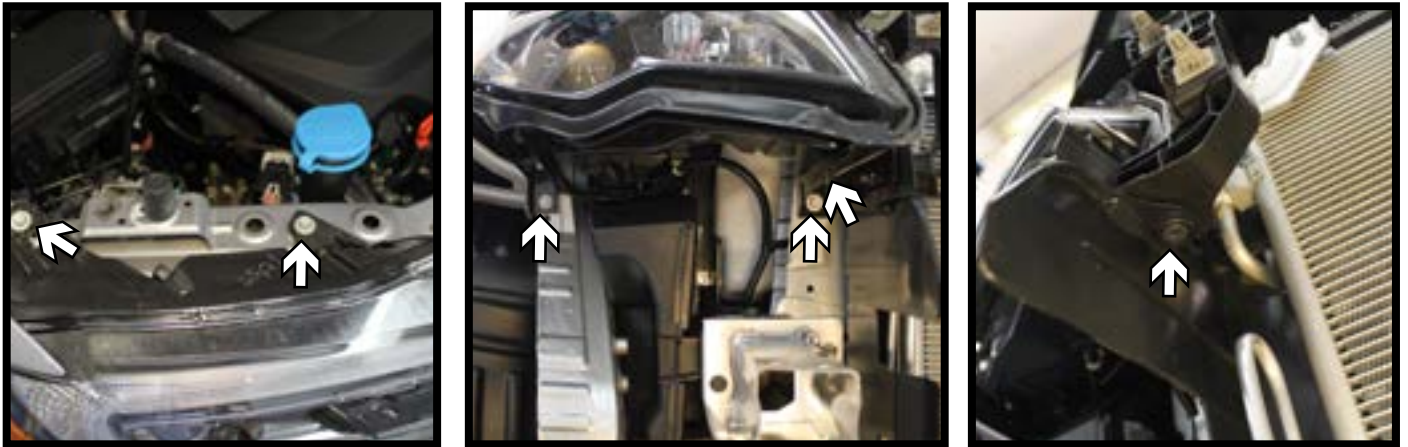

9. Using a 10MM socket, remove the five (5) screws from passenger side headlight assembly. There are two (2) on top, two (2) on the lower face and one (1) on the underside (left & middle). Next to the radiator remove the push pin as shown (right). Disconnect any electrical connections and set the assembly aside.

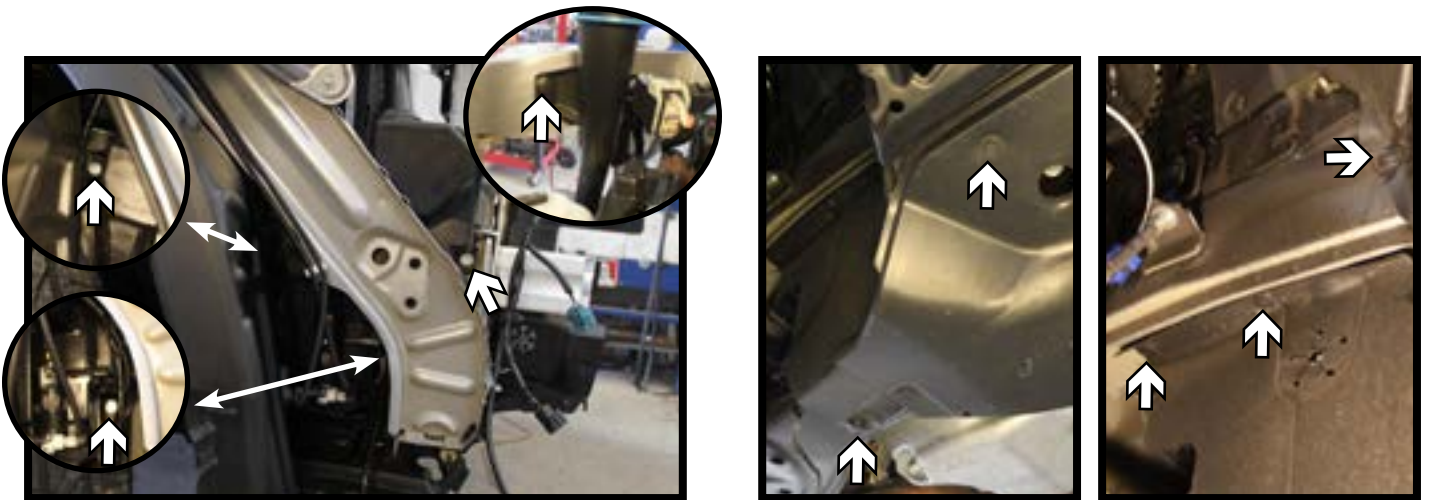

10. Using a 10MM socket, remove the three (3) screws from the washer reservoir. Then remove the one (1) push pin from the filler neck (left). Loosen the wheel well liner by removing the one (1) screw and push pin from the underside of the wheel well. Then up above inside the wheel well remove an additional three (3) push pins (left). Disconnect/plug all lines then pull the reservoir down and out thru the bottom of the vehicle and set aside.

BX2263  
2016 Honda Pilot  
Installation Instructions

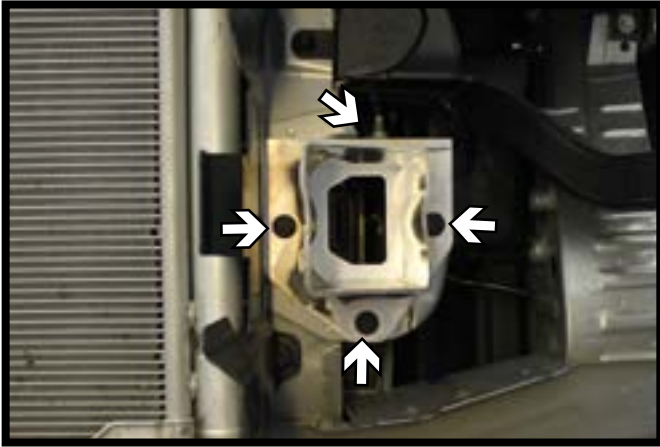

11. Using a 12MM socket, remove the three (3) bolts from the face of the frame extension. Do this on both sides of the vehicle.

On top, remove the nut from the driver side and the bolt from the passenger side. Set the extensions aside they will not be reinstalled.

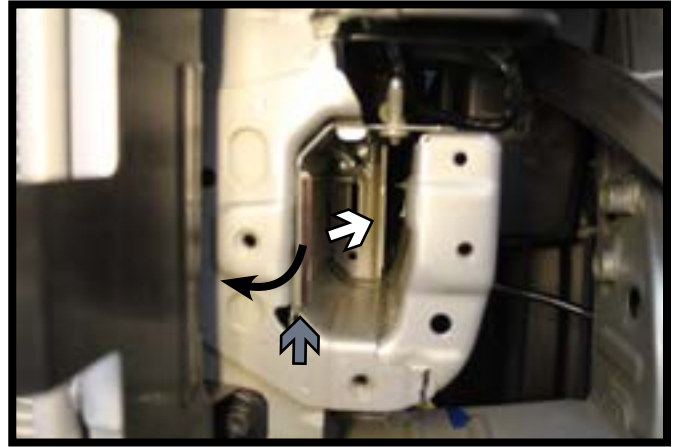

12. On the front part of the frame pocket, bend the tab forward so it is flush or just past the inside face of the frame (gray). Inside the frame pocket, bend the inner structure in so that the 3/4" nut will clear. Do this on both sides of the vehicle.

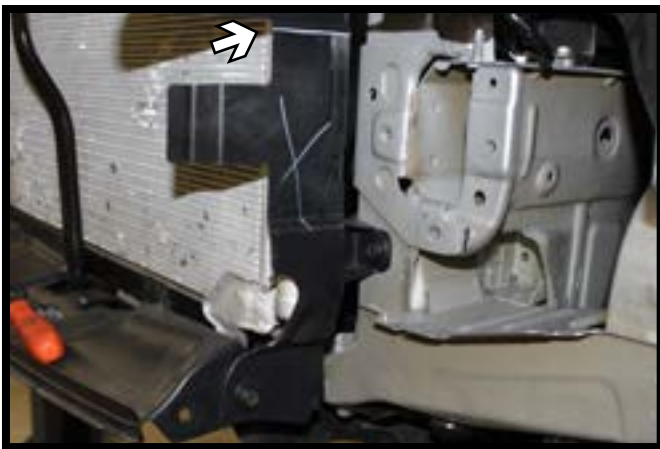

13. Trim the plastic shielding just above the frame pocket, then remove the lower push pins holding it in place. Do this on both sides of the vehicle.

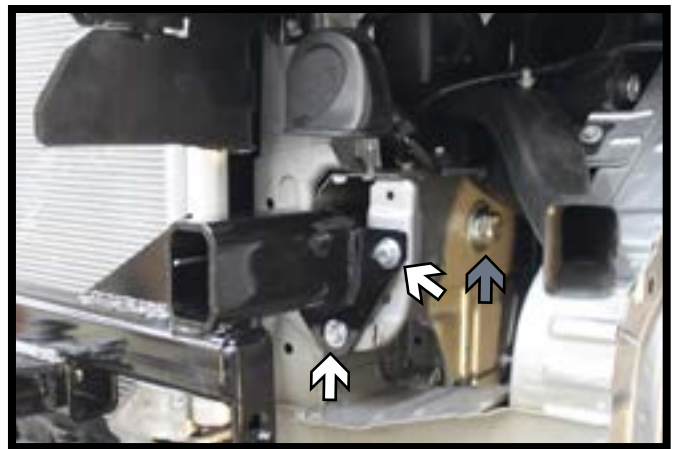

14. Install the baseplate into the frame. Start the rear 3/4" hardware into the rear hole but do not fully tighten (gray). Install the 8MM hardware into the front holes and fully tighten. Once the front bolts are tightened, fully tighten the rear 3/4" bolts.

\*\* Use Loctite® Red on all bolt threads and tighten all bolts to the appropriate torque.

BX2263  
2016 Honda Pilot  
Installation Instructions



15. Attach the permanent baseplate safety cables to the provided convenience link on the baseplate. The photo above shows the recommended installation of the cables to frame of vehicle. Additional options may interfere with suggested mounting; in this case, secure the cables to a solid piece of the frame as described in the instructions included with the permanent baseplate safety cables. Be sure the safety cables do not rub against any hoses or moving parts. Do this on **BOTH** sides of the vehicle.

16. Hold the fascia as close to its original position, mark and trim the fascia around the convenience links and attachment tabs. Reinstall the washer reservoir, air baffle, fascia and fascia cover.

## CUSTOMER SERVICE COMMITMENT

Blue Ox® is committed to providing you with exceptional customer care throughout your lifetime with our products. Our team is here to assist you with any questions you may have regarding the performance of your product. Simply call (402) 385-3051 and you can speak with our customer care team.

Additionally, please visit our website to see which rallies our Destination America team will be attending. For a nominal fee, our service technician will service your towing system to ensure it's in proper working condition. Also, as a commitment to our customers, should you visit our factory, you can stay at our full service Blue Ox® campground at no charge along with enjoying a factory tour.

Again, thank you for being our customer and for the confidence you have shown in the performance of our products. It is because of customers like you we enjoy the success we have today.

© 2015 Blue Ox  
One Mill Road, Industrial Park  
Pender, Nebraska 68047  
Phone: (402) 385-3051  
Fax: (402) 385-3360  
[www.blueox.com](http://www.blueox.com)



# General Information

1. Ensure that your product(s) are registered online at [www.blueox.com](http://www.blueox.com). It is crucial to register your product(s) so that you may be alerted of product offerings, updates, upgrades, maintenance and safety bulletins, and/or recalls.
2. **It is the owner's responsibility to inspect all towing equipment for cracked welds, missing or worn parts and loose bolts before each towing trip.** Be sure to use Loctite® Red on all bolts and tighten to the recommended specifications.
3. **It is the owner's responsibility to hook up all towing equipment per manufacturer's instructions/recommendations.**
4. Remove the attachment tabs when not in use (if applicable).

## Notice To Baseplate Installer

### 1. It is YOUR responsibility to watch for:

- Oil cooler and air conditioner lines
- Electrical wires and hoses
- Missing parts or attaching points on the frame

\*\* If the baseplate is improperly installed and is against a wire or hose, it could cause fluid leaks or electrical shorts some time after the actual baseplate installation.

## Permanent Baseplate Safety Cable Installation

Permanent baseplate safety cables are strongly recommended when towing a vehicle with a tow bar. The principle function of the permanent baseplate safety cables is to prevent the towed vehicle from breaking loose in the event the connection between the frame of the towed vehicle and the baseplate fails or becomes disconnected. The cables must be connected from the baseplate to the frame rail or cross member of the vehicle's frame. The illustrations below show the possible arrangements recommended by Blue Ox®. Each permanent baseplate safety cable must have an adequate weight rating for the towing system. The weight rating of the two (2) cables together will not qualify.

***Do not mount the permanent baseplate safety cables against wires, hoses or brake lines.***

These permanent baseplate safety cables should remain installed as long as the baseplate is installed on the vehicle. Permanent baseplate safety cables are to be used in conjunction with, and NOT a replacement for legally required safety cables attaching the towed vehicle to the towing vehicle.

### OPTION #1

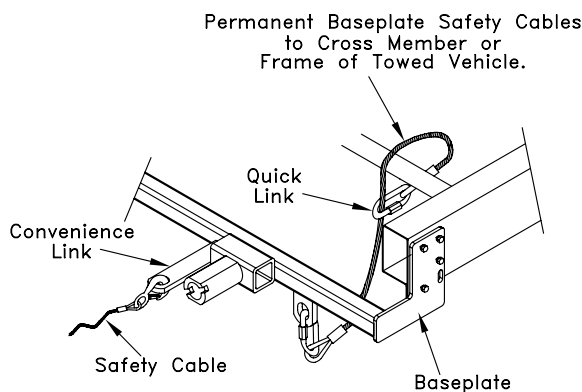

### OPTION #2

