



Baseplate Installation Instructions

BX2327

2007 Hyundai Tiburon GT V6 Installation Instructions

Serial Number

Please read BOTH these Installation Instructions and the General Towing Instructions before attempting to install or operate this equipment.

1. Blue Ox® towing products and accessories are intended to be installed by Blue Ox® Dealers who are familiar with our products and have the equipment and knowledge to do “fit work.” When necessary, Blue Ox® Dealers can be found at www.blueox.us or by contacting our 24/7 Customer Care Department at (888) 425-5382.

Attachment Tab Height: 12 1/2”
Attachment Tab Width: 24”

2. Many Blue Ox® Baseplates are designed to use existing holes and hardware to mount the baseplate to the towed vehicle. Even though bolts are there, do not assume they are adequate for baseplate mounting. Always use hardware supplied in the hardware kit or existing hardware specified in the Baseplate Towing Installation Instructions.

Bolt Torque Specifications

Torque in Foot-Pounds per Metric Bolts

Bolt Size	Grade 8.8	Grade 10.9
6MM	6	8
8MM	16	22
10MM	31	40
12MM	54	70
14MM	89	117

Confirm the towability and pre-towing procedures for your vehicle with the owner’s manual or contact the vehicle’s manufacturer for specific towing procedures. You can also contact REMCO for additional information at 1(800)228-2481.

Bolt Torque Specifications

Torque in Foot-Pounds per Inch Bolts

Bolt Size	Grade 5	Grade 8
1/4”	10	14
5/16”	19	29
3/8”	33	47
7/16”	54	78
1/2”	78	119
5/8”	154	230



! WARNING

Failure to read and follow these instructions could result in separation of the towed vehicle from the tow bar, causing property damage, loss of towed vehicle, personal injury or death.

BX2327

2007 Hyundai Tiburon GT V6

Installation Instructions

Parts List

Ref. No.	Qty.	Part #	Description
1	1	61-6403	Weldment, Baseplate, BX2327
2	6	201-0495	10MM-1.25 x 44MM HB GRD 8.8, ZP
3	6	203-0104	10MM Lock Washer, ZP
4	2	201-0553	1/4-20 x 1/2 Hx. Wshd, Type F Screw
5	2	201-0192	#10-32 x 1/2 Slot, Rd. Hd. Screw
6	2	203-0054	#10 Lock Washer
7	2	202-0047	#10-32 Hex Nut
8	2	101-5822	Adapter, 4 Way Connector
9	2	62-3469	Attachment Tab Assy, Rem, SF/LB, 1 HOLE
	2	226-0046	Permanent Baseplate Safety Cables, Class III, (Not shown)
	2	229-0359	3/8" Quick Link (Not shown)
	2	290-0437	Cap plugs (Not shown)

Tools Required

Loctite® RED
 8MM Socket
 10MM Socket
 17MM Socket
 Phillips Screwdriver
 Vise Grip
 Hack saw
 Reciprocating Saw
 Hammer

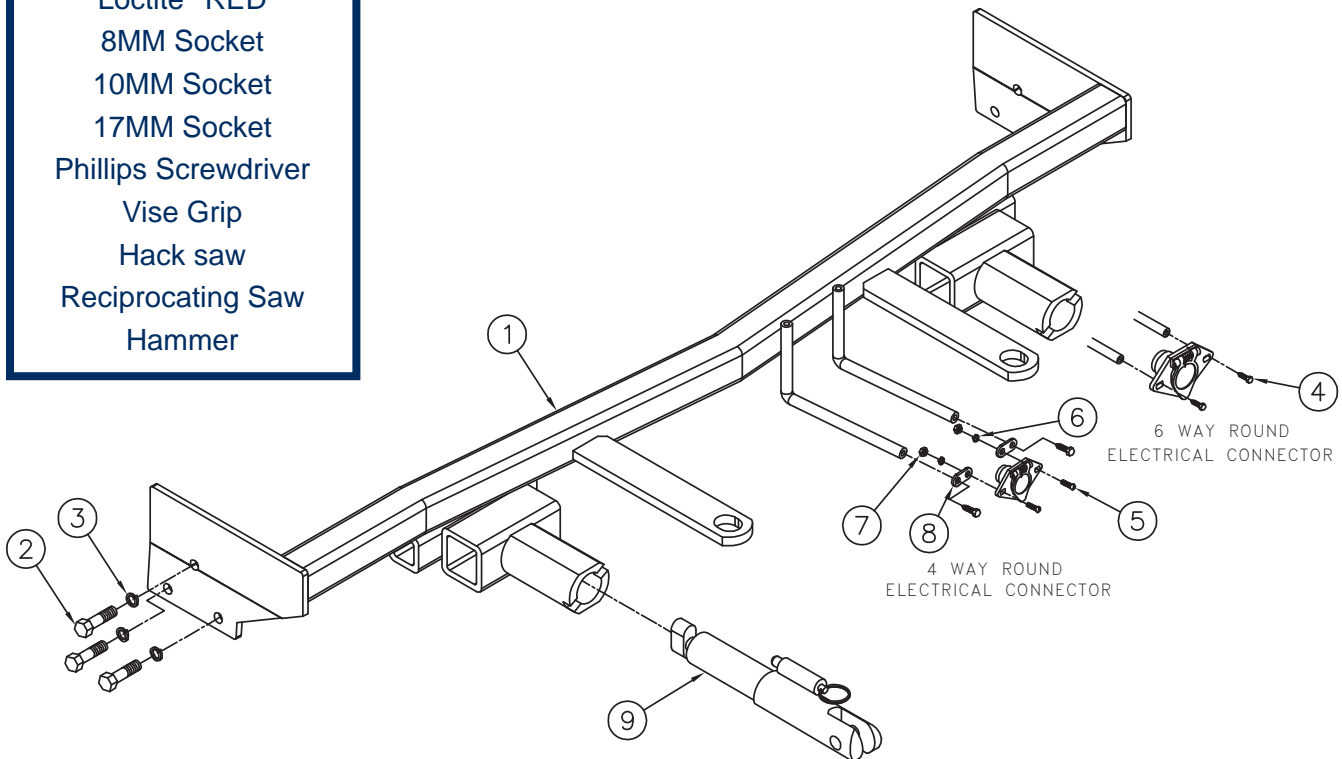

Important:

Use only genuine factory replacement parts on your baseplate. Do **NOT** substitute homemade or non-typical parts. If a bolt is lost or in need of replacement, for your safety and the preservation of your baseplate, be sure to use a replacement bolt of the same grade (In most cases it will be Grade 5, please reference the parts list above). Replacement parts may be ordered through your nearest Blue Ox® Dealer or Distributor.

2007 Hyundai Tiburon GT V6 Installation Instructions

Vehicle Weight:

The weight of this vehicle is near the Class III, 5,000 lb. rating limitations. Some models, depending on options, may well exceed this 5,000 lb. rating. Be sure to confirm the weight of your individual vehicle before towing. As of 1999, the Aventa® II is now 10,000 lbs. and either the Aventa® II or the Aventa® LX tow bar must be used for these applications.

Tow Bar Adapters are NOT to be used with vehicles weighing over 5,000 lbs.

Installation Notes: The fascia, metal bumper and headlights are removed and reinstalled during installation of the baseplate. Drilling is required. Trimming of the fascia is required.

The dimensional variations between otherwise identical vehicles can be considerable. While the baseplate was designed for easy installation, it may be necessary to tailor the baseplate slightly to compensate for auto manufacturer's tolerances. These minor adjustments may include filing a hole slightly, bending electrical rods and/ or bending end plates.

The BX8848 Diode Kit is recommended for this vehicle.

Installation Instructions:

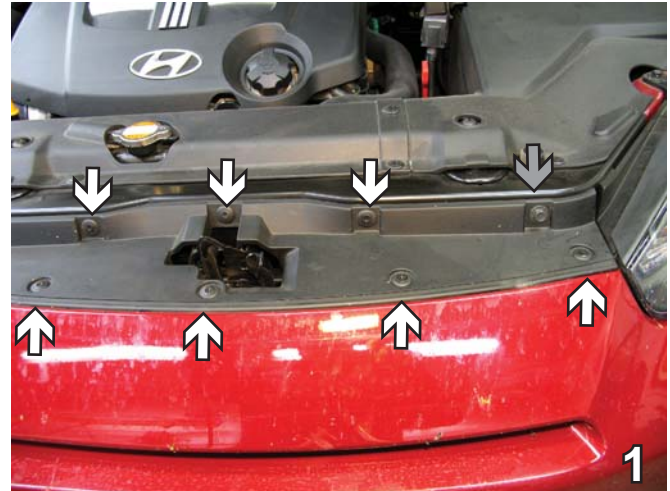

1. Using a Phillips screwdriver, remove eight plastic push pins all together from the top plastic piece along with two (gray arrow) hex bolts (one on each side). Set push pins and bolts aside to be reinstalled later.



2. The headlights will need to be removed as well. Using a 10MM socket, remove three metric bolt connecting the headlights. Do this to both sides of the vehicle. Set bolts aside to be reinstalled later.

BX2327
2007 Hyundai Tiburon GT V6
Installation Instructions



3. Unplug the headlight by pushing on the connection (gray arrow). Using a Phillips screwdriver, remove five plastic push pins under the headlight assemblies. Do this to both sides. Set bolts aside to be reinstalled later.



5. Using an 8MM socket, remove one hex bolt located just forward of the front tire of the wheel well. Do this to both sides of the vehicle and set bolts aside to be reinstalled later.

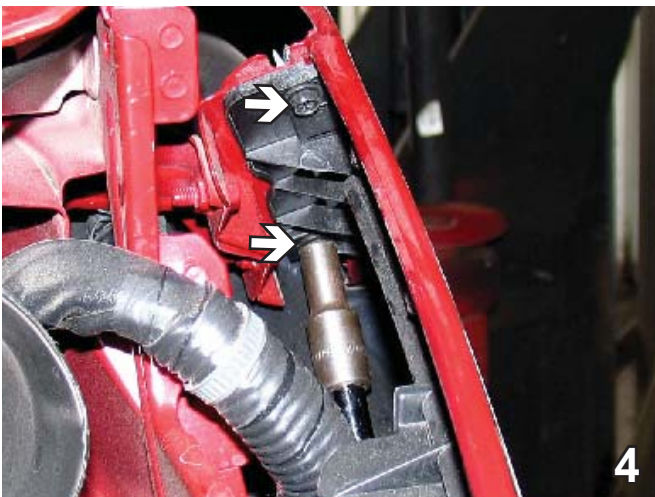

4. Using a 8MM socket, remove two hex bolts from inside the headlight assembly. Do this to both sides of the vehicle. Set bolts aside to be reinstalled later.



6. Just forward the front tire are two push pins to remove located on the lower edge of fascia. Do this to both sides and set push pins aside for later installation.

BX2327

2007 Hyundai Tiburon GT V6 Installation Instructions

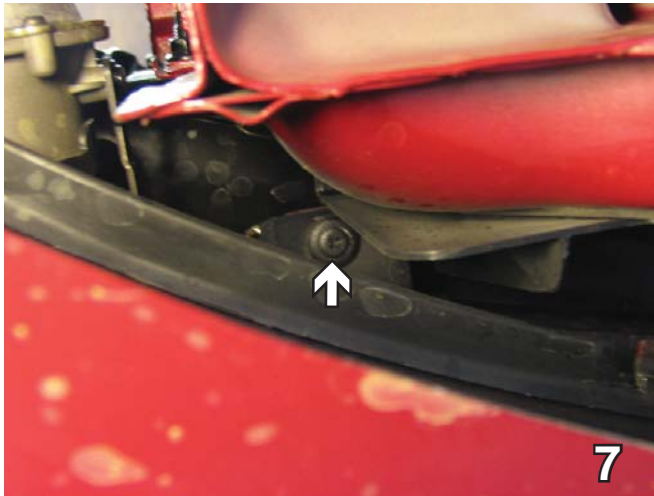

7. There is also a plastic push pin hiding under the fog lights on the back side of the fascia. Remove with a Phillips screwdriver. Remove fascia by pulling corners out to the side on both sides and pulling forward gently. Do this to both sides and set push pins and fascia aside to be reinstalled later.

NOTE: THIS PHOTO WAS TAKEN UPSIDE DOWN BENEATH THE FOG LIGHTS ON THE BACK SIDE OF THE FASCIA.

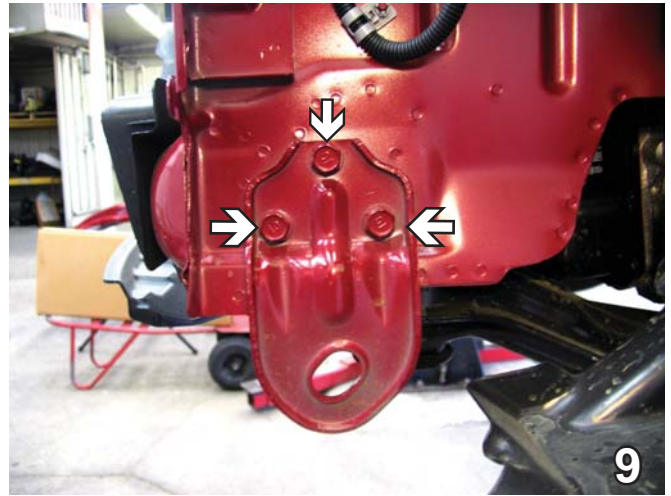

9. Remove toe hook by using a 17MM socket. Remove on both sides and set aside for later reinstallation.



10. Measure down and mark 4" then 5 3/4" on the front. Also measure and mark 8 1/2" from the top (gray arrow). Trim out the measurement from 4" to 5 3/4" with a reciprocating saw, then bend over the remaining metal down to the 8 1/2" mark towards the back of the car with a hammer. Do this to both sides.

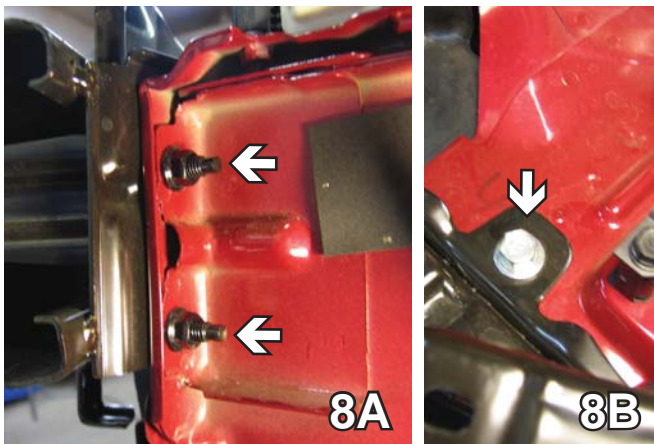

- 8A. Using a 12MM socket, remove two bolts connecting the bumper to the frame. Do this to both sides.
- 8B. Remove a bolt on the top of the bumper with a 12MM socket as well. Do this to both sides. Place all bolts aside for reinstallation later.

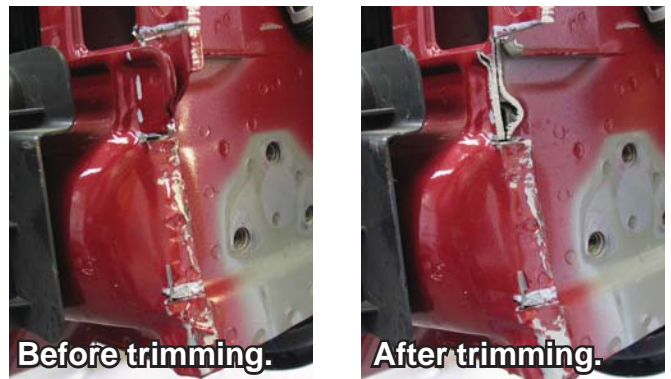

BX2327

2007 Hyundai Tiburon GT V6 Installation Instructions

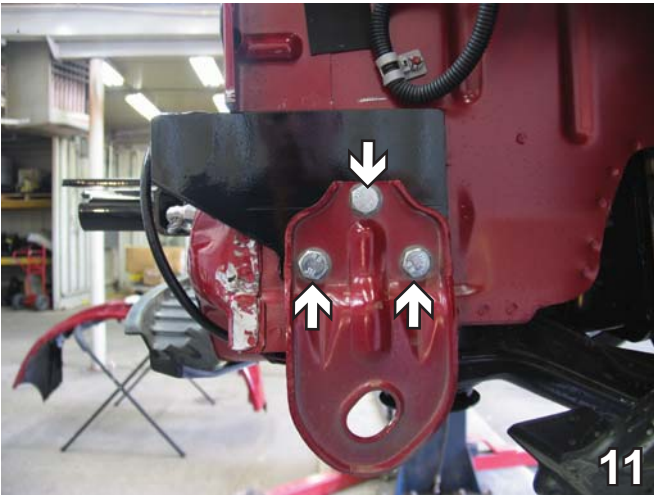

11. Slide base plate onto frame to align with existing holes for tie down bracket on each side, place tie down bracket over the top of the base plate to align with holes and begin replacing the 10MM bolts and lock washers provided. Do this to both sides. Be sure to reinstall the toe hook on both sides as well.

BE SURE TO USE LOCTITE® RED ON ALL BOLTS BEFORE TIGHTENING. TIGHTEN ALL BOLTS ACCORDING TO THE TORQUE CHART ON THE FRONT PAGE OF THESE INSTRUCTIONS OR ON PAGE 3 OF THE BASEPLATE TOWING GENERAL INSTRUCTIONS.



12. Reinstall metal bumper.

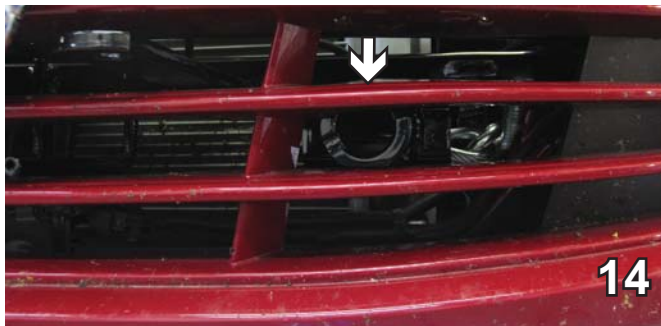

14. Hold fascia as close to it's original position as possible and trim out the areas for the convenience links for safety cables and receivers for the removable attachment tabs using a hack saw. Reinstall fascia.

Install the tow bar according to the instructions provided in its packages. When demonstrating this to the customer, be sure to include all the contents and packages.

Do **NOT** substitute other devices if the tow bar pins and clips are misplaced.

Be sure that **ALL** electrical connections are plugged in properly and functioning **BEFORE** installing the fascia.

DEALER or INSTALLER:
Be certain the user receives the instruction sheets for their products.

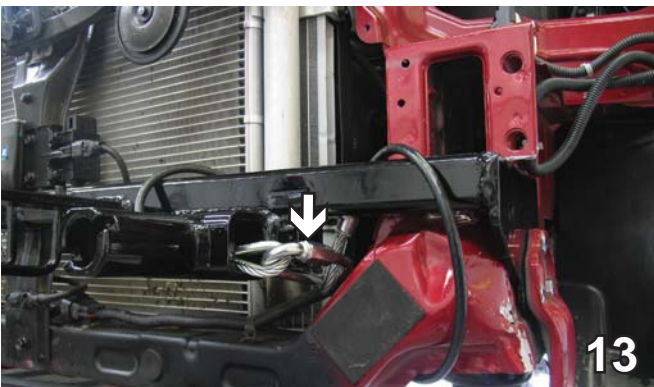

13. Install safety cables around tube and quick link. Install permanent safety cables through receiver tube, around frame cross member, and quick link ends.

BX2327

2007 Hyundai Tiburon GT V6 Installation Instructions

Customer Service Commitment



Shown without removable tabs installed.



Shown with removable tabs installed.

Blue Ox® is focused on providing exemplary customer service, as observed in our mission statement and guiding principles. In accordance with this objective, Blue Ox® is proud to provide services such as repairs and general maintenance of Blue Ox® products at over 150 RV Rallies. Look for our Destination America or Blue Ox® Racing service crews at the next rally or race that you attend. If you were not present, you will find an informative, personalized note explaining any services that may have been performed to your Blue Ox® products.

Blue Ox® also offers educational seminars at rallies and through our Park and Resort teams. In addition, Blue Ox® customers visiting our factory may take advantage of the well-equipped Blue Ox® RV park at no charge to you, our valued and appreciated customer.



© 2007 Blue Ox
One Mill Road, Industrial Park
Pender, Nebraska 68047
Phone: (402) 385-3051 • Fax: (402) 385-3360
www.blueox.us
07/28/08