



BLUE OX®

Baseplate Installation Instructions

BX2332

2010 Hyundai Genesis Coupe Installation Instructions

Serial Number

Please read BOTH these Installation Instructions and the General Towing Instructions before attempting to install or operate this equipment.

- Blue Ox® towing products and accessories are intended to be installed by Blue Ox® Dealers who are familiar with our products and have the equipment and knowledge to do “fit work”. When necessary, Blue Ox® Dealers can be found at www.blueox.com or by contacting our Customer Care Department at (402) 385-3051.
- Many Blue Ox® baseplates are designed to use existing holes and hardware to mount the baseplate to the towed vehicle. Even though bolts are there, do not assume they are adequate for baseplate mounting. Always use hardware supplied in the hardware kit or existing hardware specified in the Baseplate Installation Instructions.

Attachment Tab Height: 13”
Attachment Tab Width: 17”

Bolt Torque Specifications

Torque in Foot-Pounds for Metric Bolts

Bolt Size	Grade 8.8	Grade 10.9
6MM	6	8
8MM	16	22
10MM	31	40
12MM	54	70
14MM	89	117

Confirm the towability and pre-towing procedures for your vehicle with the owner’s manual or contact the vehicle’s manufacturer for specific towing procedures.

Bolt Torque Specifications

Torque in Foot-Pounds for Inch Bolts

Bolt Size	Grade 5	Grade 8
1/4”	10	14
5/16”	19	29
3/8”	33	47
7/16”	54	78
1/2”	78	119
5/8”	154	230



If the front of your vehicle looks different than this, call us at (402) 385-3051.

WARNING

Failure to read and follow these instructions could result in separation of the towed vehicle from the tow bar, causing property damage, loss of towed vehicle, personal injury or death.

BX2332

2010 Hyundai Genesis Coupe

Installation Instructions

Parts List

Ref. No.	Qty.	Part #	Description
1	1	61-6878	Weldment, BP, BX2332
2	4	61-5208	Weldment, Nut Plate, 1/4X1X1, 3/8"/14"Wire
3	4	201-0422	10MM-1.25 X 30MM Hex Bolt GR.8.8 ZP
4	4	201-0368	3/8-16 X 1 1/4 Hex Head Bolt,GRD. 5
5	4	203-0104	10MM Lock Washer, ZP.
6	4	203-0103	10MM Flat Washer, ZP.
7	4	203-0010	3/8 Lock Washer, ZP
8	2	201-0553	1/4-20 x 1/2" Hx. Wshd, Type F Screw
9	2	201-0192	#10-32 x 1/2" Slot, Rd. Hd. Screw
10	2	203-0054	#10 Lock Washer
11	2	202-0047	#10-32 Hex Nut
12	2	101-5822	Adapter, 4 Way Connector
13	2	62-3468	Attachment, Assembly, SF/SB (R)
14	1	102-7056	Coolant Bracket
15	2	201-0050	1/4-20 X 3/4 Hex Bolt GRD.5, ZP
16	2	202-0102	1/4-20 Hex Nyl Nut, ZP
	2	290-0437	Receiver, Cap Plug, Blk (Not Shown)
	2	229-0359	Quicklink, 3/8, ZP (Not Shown)
	2	226-0046	Baseplate Safety Cable, 36" CL III (Not Shown)

Tools Required

8MM Socket	Reciprocating Saw
10MM Socket	Flat Screwdriver
12MM Socket	Phillips Screwdriver
14MM Socket	Torque Wrench
17MM Socket	Drill
9/16" Socket	13/32" Drill Bit
Utility Knife	9/32" Drill Bit
Loctite® RED	

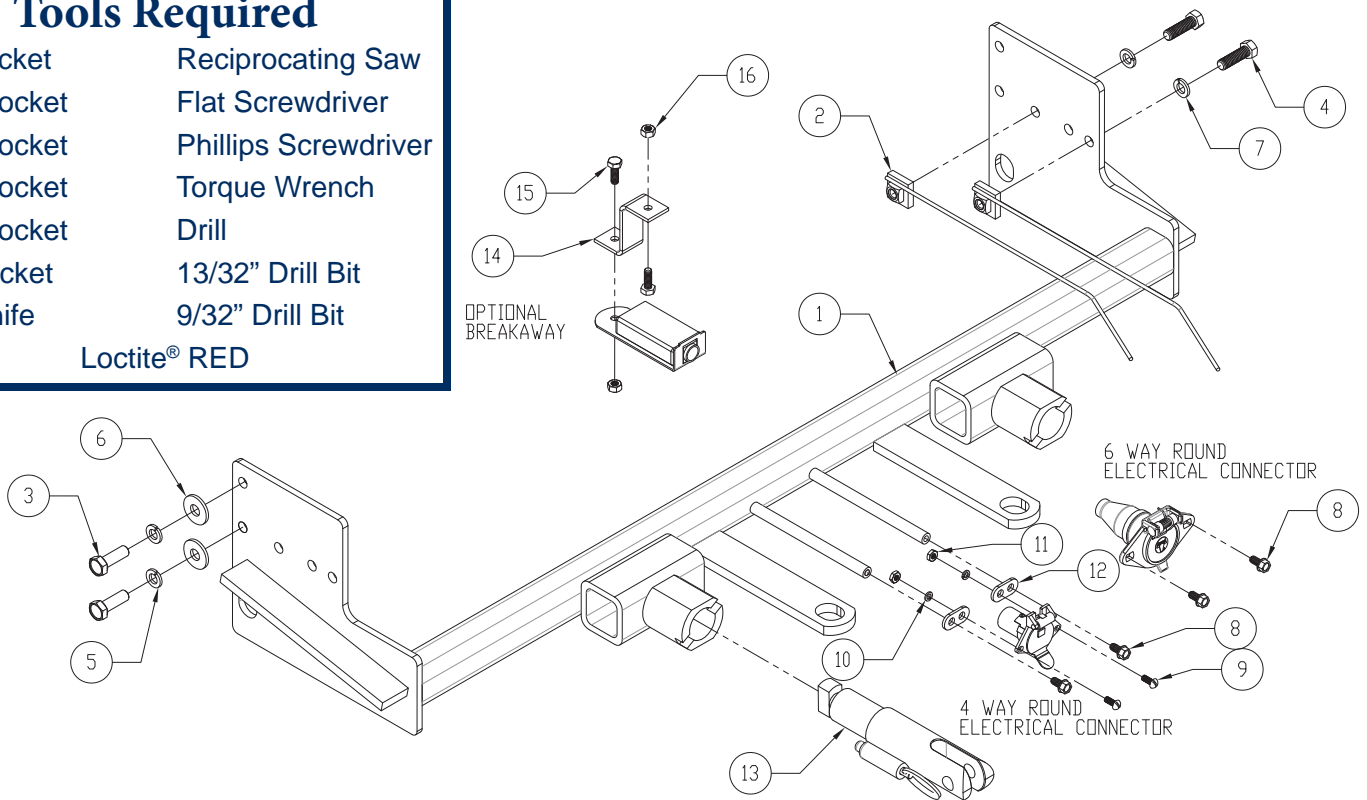

Important:

Use only genuine factory replacement parts on your baseplate. Do **NOT** substitute homemade or non-typical parts. If a bolt is lost or in need of replacement, for your safety and the preservation of your baseplate, be sure to use a replacement bolt of the same grade (In most cases it will be Grade 5, please reference the parts list above). Replacement parts may be ordered through your nearest Blue Ox® Dealer or Distributor. Failing to follow and/or altering these installation instructions in either installation or required equipment will void the manufacturer's warranty.

BX2332
2010 Hyundai Genesis Coupe
Installation Instructions

Attachment Tabs:

Due to the design of the removable tabs, the RangeFinder II, Adventurer, Acclaim and Ambassador tow bars can not be used. Adapters, except the BX8833 and BX88151, can not be used with this baseplate.

Installation Notes:

The fascia, washer reservoir, metal bumper, coax hose, christmas tree plug and air bag sensor are removed. Trimming of the air dams and frame webbing is required. Drilling is required.

The dimensional variations between otherwise identical vehicles can be considerable. While the baseplate was designed for easy installation, it may be necessary to tailor the baseplate slightly to compensate for auto manufacturer's tolerances. These minor adjustments may include filing a hole slightly, bending electrical rods or bending end plates.

The BX8869 Bulb and Socket Wiring Kit is recommended for this vehicle.



Handling of some cosmetic parts when installing this product may require the use of protective covers, rags, specialty tools, etc. to prevent damage.

Installation Instructions:



1. Using a Phillips screwdriver, remove four plastic pins from the top of the fascia. Do this on both sides of the vehicle. Set pins aside to be reinstalled later.



2. Using the 8MM socket, remove one metric bolt from edge of fascia, just inside wheel well. Do this to both sides of the vehicle. Set bolts aside to be reinstalled later.

BX2332
2010 Hyundai Genesis Coupe
Installation Instructions



3. Using a flat screwdriver, remove two pushpins from the bottom corner of fascia. Do this to both sides of the vehicle. Set pushpins aside to be reinstalled later.
4. Lift up and pull the upper corners of fascia to the side to release from the tabs. Under the headlight use a flat screwdriver to lift up and pull out to unsnap. Do this to both sides of the vehicle. Pull fascia forward to remove. Set fascia aside carefully to be reinstalled later.



5. On the passenger side, disconnect the hose and electrical connection from the washer reservoir and plug the hose. Using the 10MM socket, remove three metric bolts from the washer reservoir. Remove washer reservoir. Set bolts and reservoir aside to be reinstalled later.

BX2332
2010 Hyundai Genesis Coupe
Installation Instructions



6. Using a 12MM socket, remove one bolt below the bumper and the two outside bolts above the bumper (white arrows). Using a 10MM socket, remove the middle bolt above the bumper (gray arrow). Do this to both sides of the vehicle. Set the bolts and bumper aside to be reinstalled later.



7. Remove the three push pins holding the coax hose and move out of the way for baseplate installation. Do this to both sides of the vehicle. Set the push pins aside to be reinstalled later.

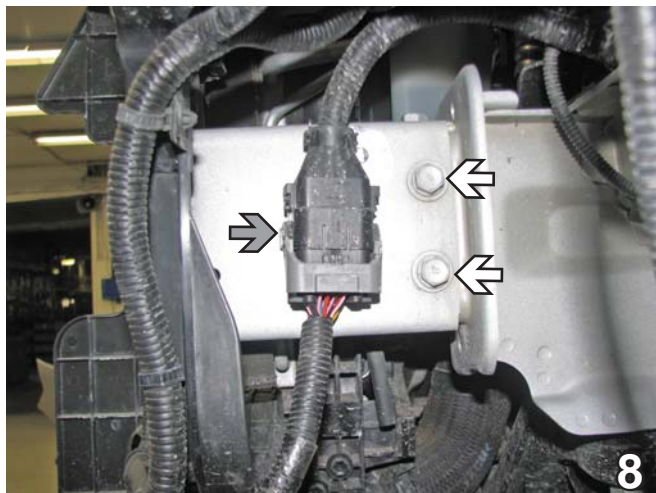

8. On the drivers side, pull out christmas tree plug from frame extension on the back side of electrical connector and pull electrical connection out of the way to install baseplate (gray arrow). Remove the two metric bolts with the 14MM socket (white arrows). Do this to both sides. These bolts will not be used later.



9. Using a utility knife, cut across the air dam flush with the bottom of the bumper and remove lower portion of air dam. Do this to both sides of the vehicle.

BX2332
2010 Hyundai Genesis Coupe
Installation Instructions

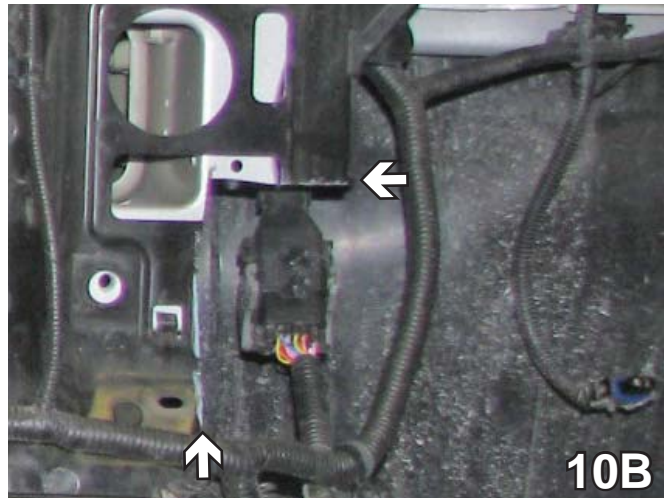
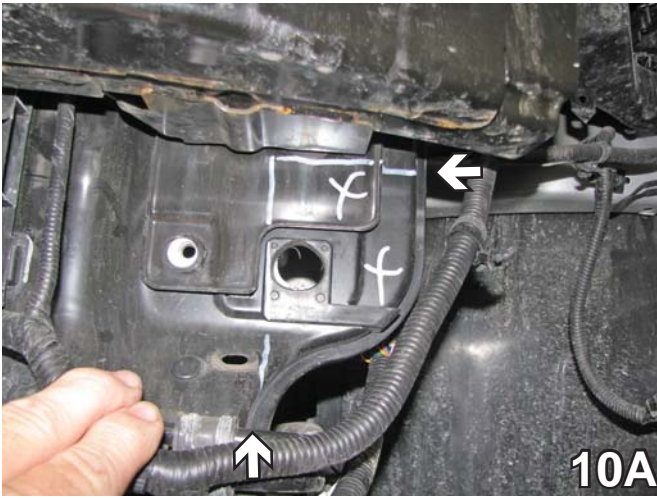

10. Using the reciprocating saw, make a horizontal cut in the frame webbing flush with the bottom of the bumper and straight up from the side of the frame (drivers side shown). Do this to both sides of the vehicle.



11. Unplug the air bag sensor by the corner of the headlight and move the electrical coax out of the way. It will be reinstalled later. Do this to both sides of the vehicle.

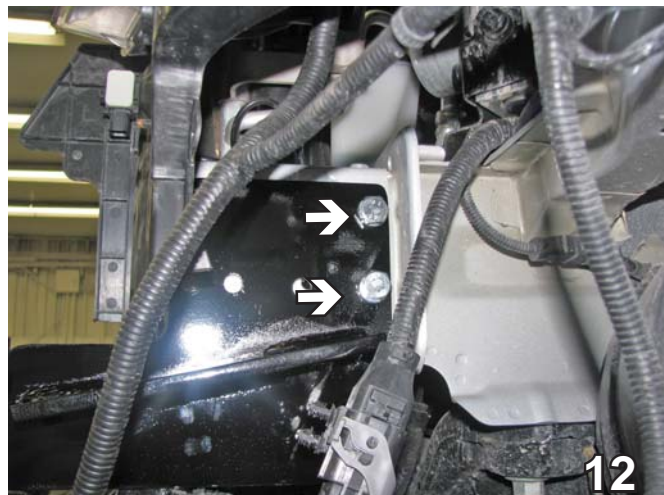

12. Slide the baseplate on to frame that will align with existing bolt holes, start two 10MM-1.25 x 30MM bolts in the existing back holes with 10MM lock washers and 10MM flat washers. Be sure the baseplate is level with respect to the vehicle frame and tighten the bolts with the 17MM socket. Be sure to use Loctite Red on all bolts. Do this to both sides of the vehicle.

BE SURE TO USE LOCTITE® RED ON ALL BOLTS BEFORE TIGHTENING. TIGHTEN ALL BOLTS ACCORDING TO THE TORQUE CHART ON THE FRONT PAGE OF THESE INSTRUCTIONS OR ON PAGE 3 OF THE BASEPLATE TOWING GENERAL INSTRUCTIONS.

BX2332
2010 Hyundai Genesis Coupe
Installation Instructions

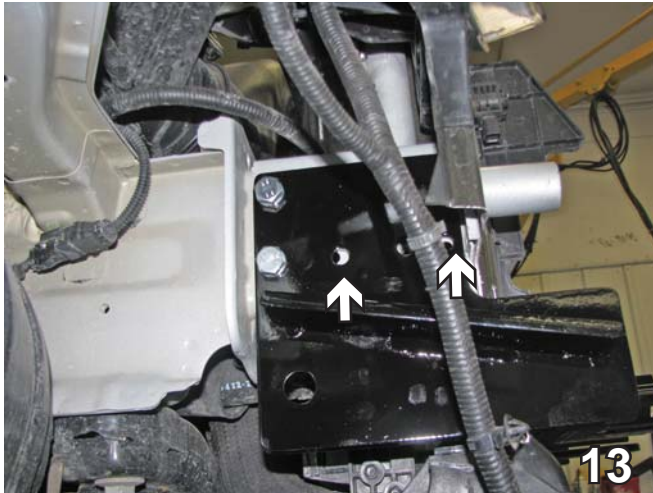

13. Using baseplate as a template, drill two holes into frame rail with the 13/32" drill bit. Do this to both sides of the vehicle.

When using power drills be aware of the dangers of torque and drill bit length.



14. Insert 3/8-16 nut plates through the frame end opening. Align to the lower outside two drilled holes. Install 3/8-16 x 1 1/4" hex bolts with 3/8" lock washers and tighten. Be sure to use Loctite Red on all bolts. Do this to both sides of the vehicle.



15. Attach the permanent baseplate safety cables to the provided convenience link on the baseplate (see white arrow). The photo above shows the recommended installation of the cables to the frame of vehicle (see gray arrow). Additional options may interfere with the suggested mounting. In this case, secure the cables to a solid piece of the frame as described in the instructions included with the permanent baseplate safety cables. Be sure the safety cables do not rub against any hoses or moving parts. Do this on both sides of the vehicle.



16. On the passenger side, reinstall the washer reservoir using the existing bolts. Reconnect the hose and electrical connection.

BX2332
2010 Hyundai Genesis Coupe
Installation Instructions

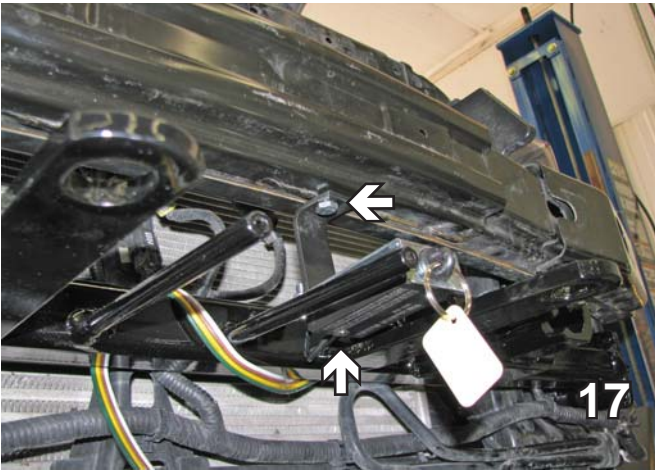

17. **Optional:** Drill a hole into the bottom of the bumper 3/4" from the front side and halfway between electrical rod and convenience link on the drivers side with a 9/32" drill bit. Fasten the bracket to the underside of the bumper with 1/4-20 x 3/4" hex bolt and 1/4-20 hex nut. Attach the breakaway to the bracket with a 1/4-20 x 3/4" hex bolt and 1/4-20 hex nut.

Be sure that **ALL** electrical connections are plugged in properly and functioning **BEFORE** installing the fascia.

18. Reinstall the air bag sensor coax cables, christmas tree plug, bumper and fascia.

Install the tow bar and safety cables according to the instructions provided in their packages. When demonstrating this to the customer, be sure to include all the contents and packages.

Do **NOT** substitute other devices if the tow bar pins and clips are misplaced.

DEALER or INSTALLER:
Be certain the user receives the instruction sheets for their products.

BX2332
2010 Hyundai Genesis Coupe
Installation Instructions



Shown without removable tabs installed.



Shown with removable tabs installed.

If the baseplate is in an accident, it must be replaced. DO NOT use it again! An accident can cause unseen damage and using it again could result in more damage or serious injury. DO NOT use the baseplate if it is damaged or missing parts.

CUSTOMER SERVICE COMMITMENT

Blue Ox is committed to providing you with exceptional customer care throughout your lifetime with our products. Our team is here to assist you with any questions you may have regarding the performance of your product. Simply call 1-(402) 385-3051 and you can speak with our customer care team.

Additionally, please visit our website to see which rallies our Destination America team will be attending. For a nominal fee, our service technician will service your towing system to ensure it's in proper working condition. Also, as a commitment to our customers, should you visit our factory you can stay at our full service Blue Ox campground at no charge along with enjoying a factory tour.

Again, thank you for being our customer and for the confidence you have shown in the performance of our products. It is because of customers like you we enjoy the success we have today.



© 2011 Blue Ox
One Mill Road, Industrial Park
Pender, Nebraska 68047
Phone: (402) 385-3051
Fax: (402) 385-3360
www.blueox.com
4/26/11