



BX2407

2012-14 Dodge Challenger Installation Instructions

Serial Number

Attachment Tab Height: 12-1/4"

Attachment Tab Width: 24"

Please read BOTH these Installation Instructions and the General Instructions prior to installing or operating this equipment.

- Blue Ox® towing products and accessories are intended to be installed by Blue Ox® Dealers who are familiar with our products and have the equipment and knowledge necessary to do "fit work". If needed, Blue Ox® Dealers can be found at www.blueox.com or by contacting our Customer Care Department at (402) 385-3051.
- Many Blue Ox® baseplates are designed to use existing holes and hardware to mount the baseplate to the towed vehicle. Even though bolts are there, do not assume they are adequate for baseplate mounting. Always use the hardware supplied in the hardware kit and existing hardware as specified in the installation instructions.

Bolt Torque Specifications
Torque in Foot-Pounds for Inch Bolts

Bolt Size	Grade 5	Grade 8
1/4"	10	14
5/16"	19	29
3/8"	33	47
7/16"	54	78
1/2"	78	119
5/8"	154	230
3/4"	257	380



Bolt Torque Specifications
Torque in Foot-Pounds for Metric Bolts

Bolt Size	Grade 8.8	Grade 10.9
6MM	6	8
8MM	16	22
10MM	31	40
12MM	54	70
14MM	89	117
16MM	161	230
18MM	222	318

If the front of your vehicle looks different than this, please contact us at (402)385-3051.

Reference your vehicle owner's manual for manufacturer's towing specifications.

! WARNING

Failure to read and follow these instructions could result in separation of the towed vehicle from the tow bar, causing property damage, loss of towed vehicle, personal injury or death.

BX2407
2012-14 Dodge Challenger
Installation Instructions

Instruction Notes: The fascia, air baffle and windshield washer fluid reservoir are removed and reinstalled for the baseplate installation. Some drilling and trimming is required.

Place all components that are removed on a flat, sturdy surface. All items will be reinstalled unless otherwise noted after the baseplate is installed.

The dimensional variations between otherwise identical vehicles can be considerable. While the baseplate was designed for easy installation, it may be necessary to tailor the baseplate slightly to compensate for vehicle manufacturer's tolerances.

The BX8869 Tail Light Wiring Kit is recommended for this vehicle.



Drill a hole according to the tail
light wiring kit instructions.

NOTICE

- Handling of some cosmetic parts when installing this product may require the use of protective covers, rags, specialty tools, etc. to prevent damage.
- When using power drills be aware of the dangers of torque and drill bit length.
- When using a reciprocating saw be aware of objects behind the cutting surface.
- Use a good quality paint to spray cut edges of frame to prevent rusting.
- Be sure that **ALL** electrical connections are plugged in and accessories are functioning properly before reinstalling the fascia.
- **DO NOT** use the towed vehicle for storing luggage, equipment, etc. The baseplate is computer tested to your vehicle's GVWR, exceeding this weight will void the manufacturer's warranty.
- Be sure to use Loctite® Red on all bolts before tightening. Tighten all bolts according to the torque chart provided.
- Dealer or installer be certain the user receives these instruction sheet.
- If the baseplate is in an accident, it must be replaced. **DO NOT** use it again! An accident can cause unseen damage and using it again could result in more damage or serious injury. **DO NOT** use the baseplate if it is damaged or missing parts.

BX2407

2012-14 Dodge Challenger

Installation Instructions

Tools Required

Large Vise Grip
 Flat Screwdriver
 Utility Knife
 Phillips Screwdriver
 Torque Wrench
 Drill
 Reciprocating Saw
 Tape Measure
 Loctite® RED
 13/32" Drill Bit
 6MM Socket
 6MM Wrench
 7MM Socket
 10MM Socket
 10MM Wrench
 9/16" Socket
 9/16" Wrench

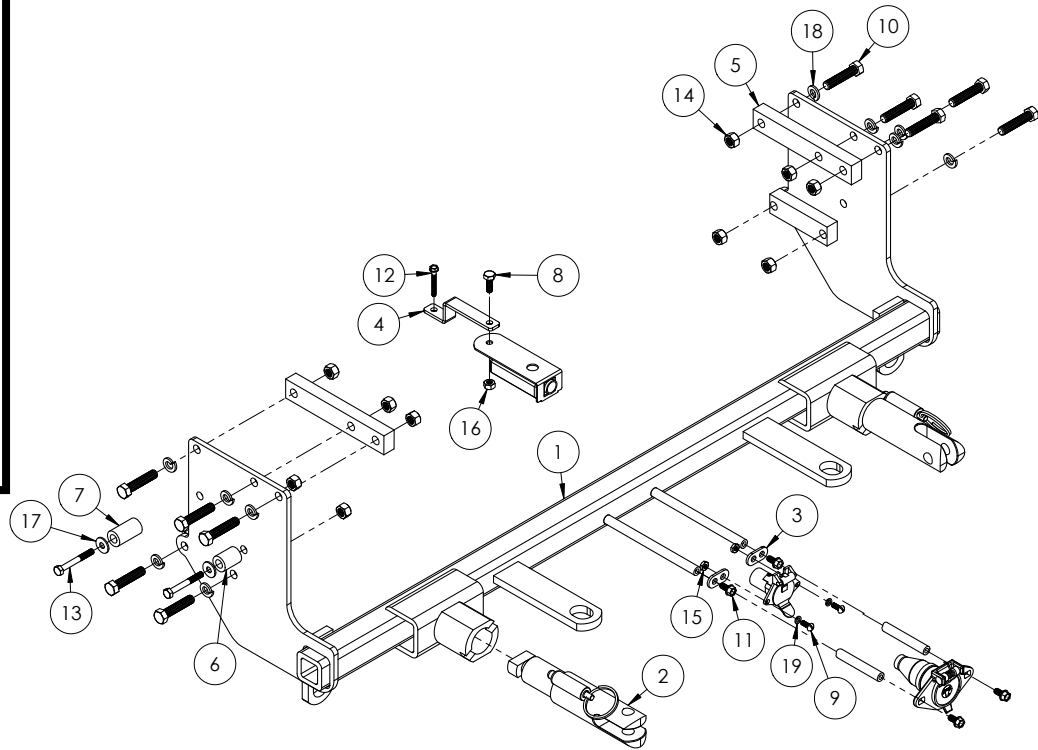

Item No.	Part No.	Description	Qty.
1	61-7135	BX2407 Baseplate	1
2	62-3468	Attachment Tab Assembly with Hole	2
3	101-5822	4 Way Connector Adapter	2
4	102-7440	BX2407 Breakaway Bracket	1
5	102-7446	5/8" Flat Spacer	2
6	107-3412	3/4" Spacer Tube x 1"L	1
7	107-3413	3/4" Spacer Tube x 1-3/8"L	1
8	201-0050	1/4"-20 x 3/4" Hex Head Bolt, Grade 5, ZP	1
9	201-0192	#10-32 x 1/2" Round Slot Head Screw	2
10	201-0404	3/8"-16 x 1-3/4" Hex Head Bolt, Grade 5, ZP	10
11	201-0553	1/4"-20 x 1/2" Hex Wshd Screw, ZP	2
12	201-0654	#10-16 x 1" Self Drilling Screw, ZP	1
13	201-0798	6MM-1MM x 50MM Hex Head Bolt, Grade 8.8, ZP	2
14	202-0003	3/16"-16 Hex Nut, ZP	10
15	202-0047	#10-32 Hex Nut	2
16	202-0102	1/4"-20 Hex Nylon Nut, ZP	1
17	203-0001	1/4" Flat Washer, ZP	2
18	203-0010	3/8" Lock Washer, ZP	10
19	203-0054	#10 Lock Washer	2
20	226-0046(not shown)	Class III Safety Cables	2
21	229-0359(not shown)	3/8" Quicklink, ZP	2
22	290-0437(not shown)	Black Cap Plug Receiver	2
23	293-1339(not provided)	Breakaway Switch	1
24	294-0805(not provided)	4 Pin Connector	1
25	294-0902(not provided)	6 Pin Connector	1

Important:

Use only genuine factory replacement parts on your baseplate. Do **NOT** substitute homemade or non-typical parts. If a bolt is lost or in need of replacement, for your safety and the preservation of your baseplate, be sure to use a replacement bolt of the same grade (In most cases it will be Grade 5, please reference the parts list above). Replacement parts may be ordered through your nearest Blue Ox® Dealer or Distributor. Failing to follow and/or altering these installation instructions in either installation or required equipment will void the manufacturer's warranty. Towing behind a non-motorized vehicle will void the warranty.

BX2407
2012-14 Dodge Challenger
Installation Instructions



1. Lift up and remove the plastic radiator covers from both the passenger and driver side of the vehicle.

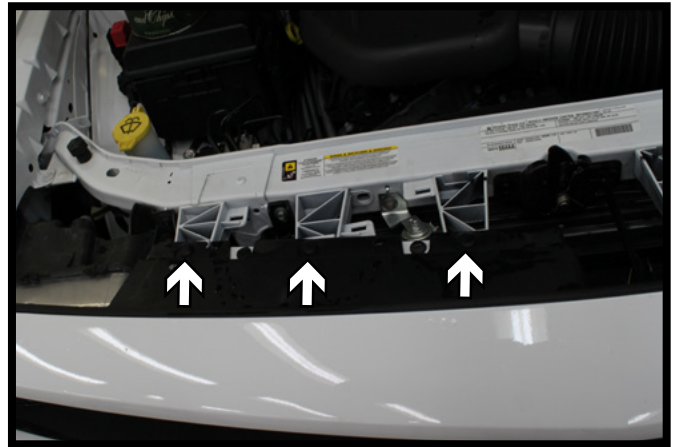

2. Remove the six (6) push pins from the top side of the fascia. Three (3) push pins from both sides of the vehicle.

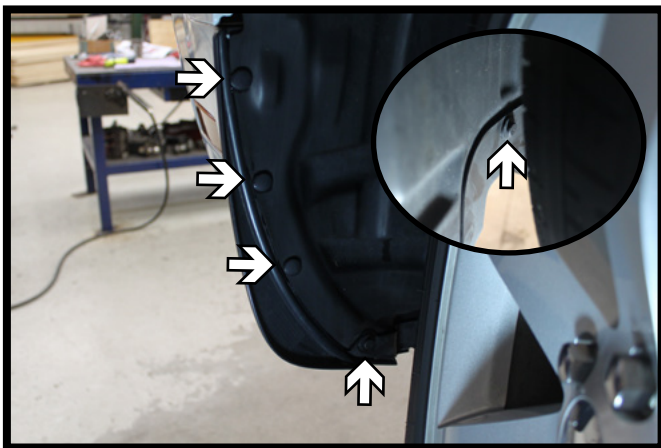

3. Remove the five (5) pushpins from the wheel well. Four (4) from the outer edge and one (1) on the inner bottom edge. Do this on both sides of the vehicle.

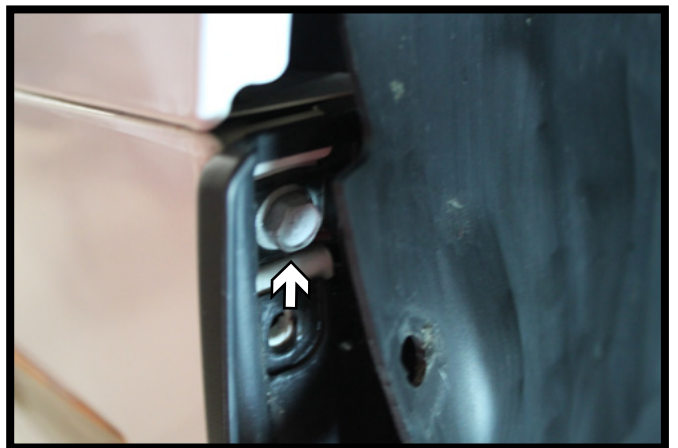

4. Using a 10MM socket, remove the screw from behind the wheel well cover at the top edge of the fascia. Do this on both sides of the vehicle.

BX2407
2012-14 Dodge Challenger
Installation Instructions

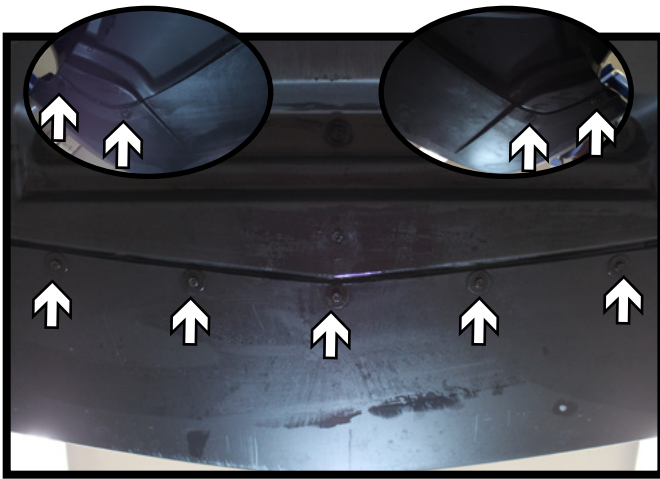

5. Using a 7MM socket, remove the nine (9) screws from the bottom edge of the fascia. There are two (2) on each side and five (5) in the center.

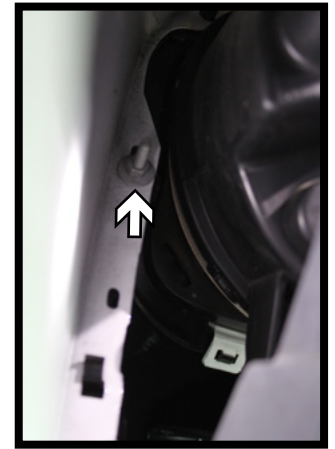
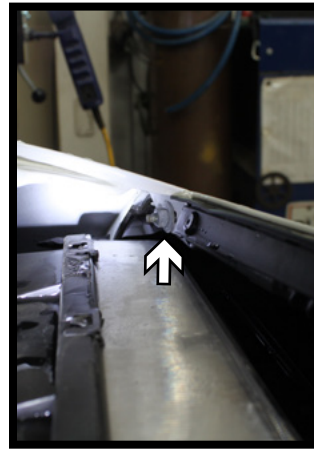

6. Using a 10MM Socket, remove the two (2) nuts from the fascia studs. One (1) is located at on the top side above the headlight (left) and the other in behind the wheel well cover (right). Do this on both sides of the vehicle. Remove the fascia from the vehicle, unhooking any electrical connections from the vehicle.

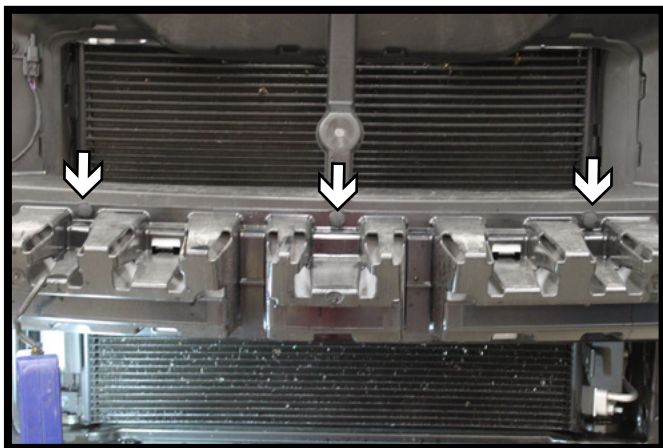

7. Remove the three (3) push pins from the plastic fascia support and unsnap from the metal bumper.

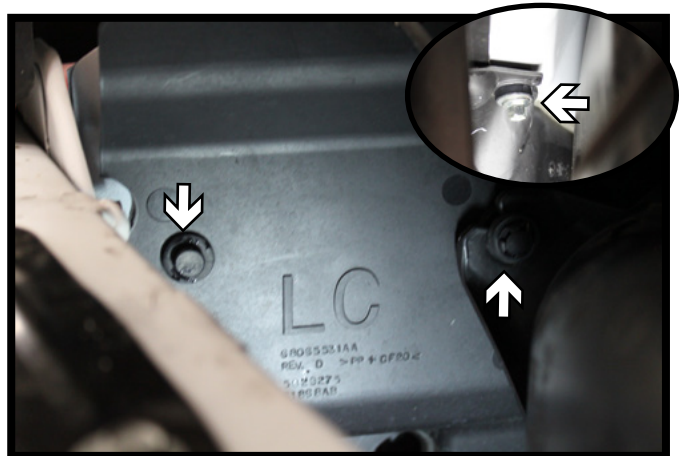

8. On the driver side, remove the two (2) push pins from the plastic shrouding. Then using a 7MM socket, remove the screw from behind the air baffle. Set the air baffle aside.

BX2407
2012-14 Dodge Challenger
Installation Instructions

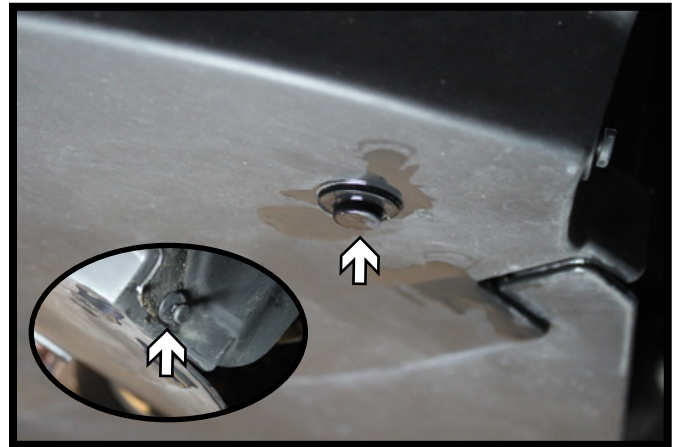
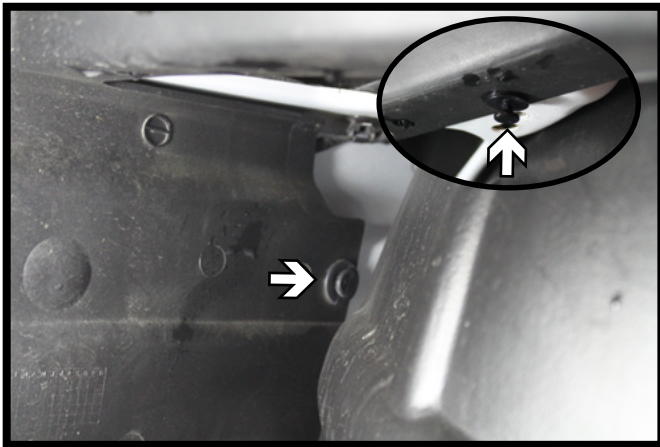

9. Remove the plastic shrouding on the driver side. On the top side, remove the rear push pin and the upper push pin (left). On the underside of the shrouding, remove the bottom push pin and the push pin located just inside the wheel well (right)

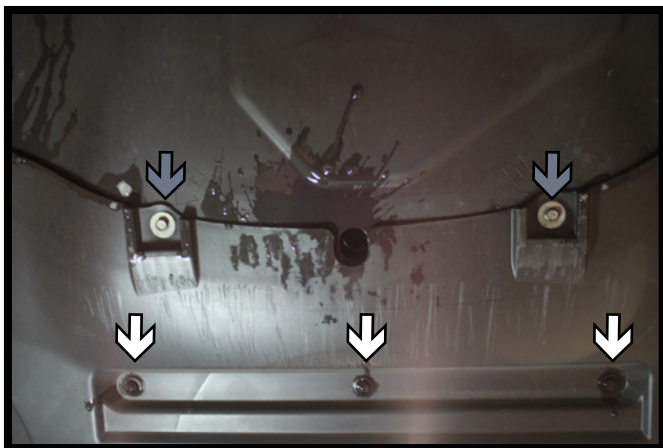

10. On the underside of the vehicle remove the plastic sheilding. Remove the three (3) push pins (white). Then using a 10MM socket, remove the two (2) bolts (gray).

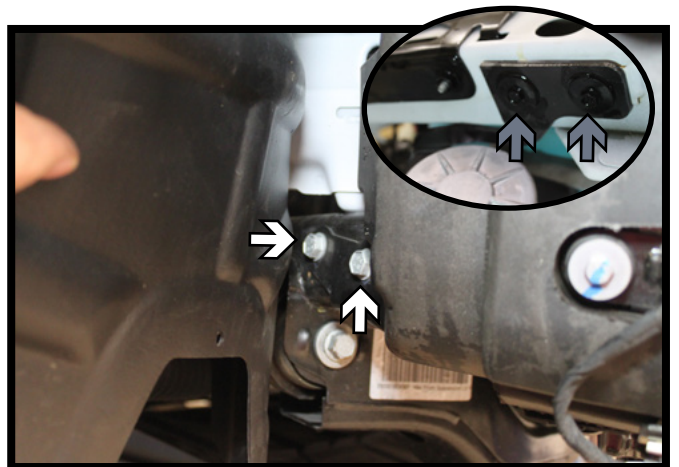

11. On the passenger side the power steering pump will need to be dropped down for clearance. Using a 10MM socket, remove the two (2) bolts from the rear bracket (white) and the two (2) bumper bracket bolts (gray).

BX2407
2012-14 Dodge Challenger
Installation Instructions

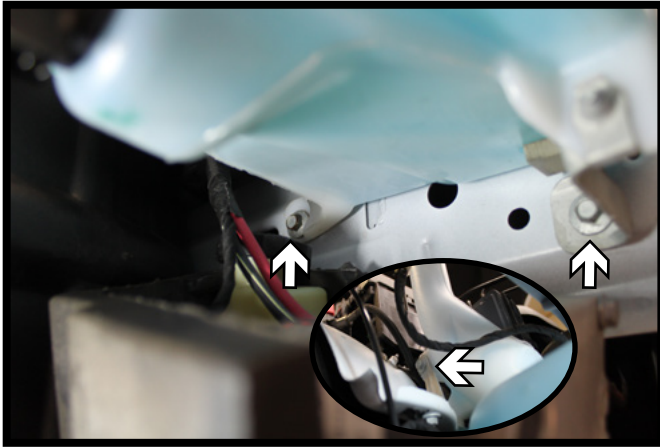

12. Using a 10MM socket, remove the two (2) screws from the bottom side of the washer reservoir. Then remove the upper screw, disconnect lines and set the reservoir aside.

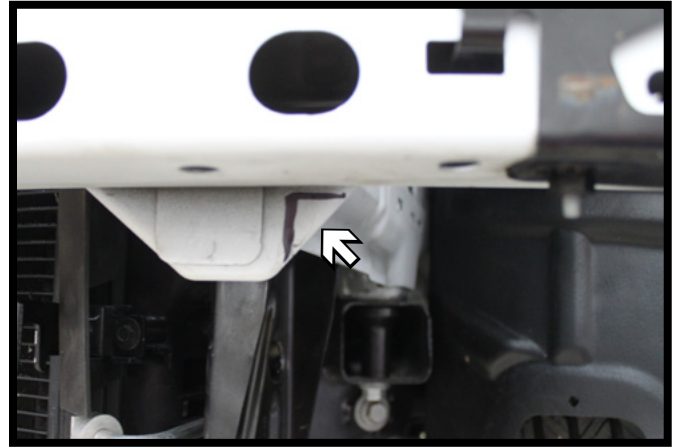

13. Using a reciprocating saw, notch the frame end flush with the bottom of the bumper and flush with the outside of the frame. Do this on both sides of the vehicle.

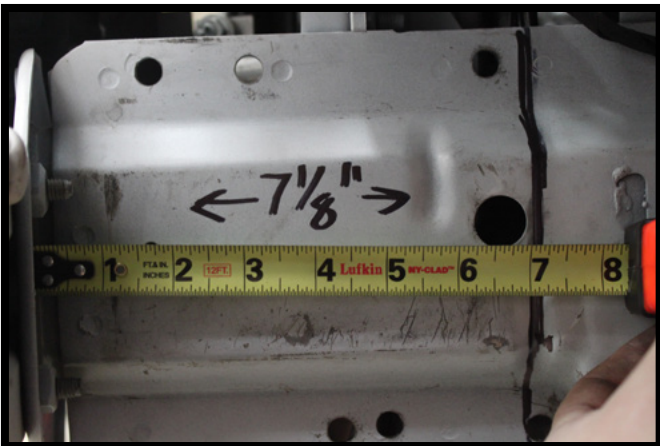

14. Measure back from the backside of the frame end plate 7-1/8" and make a mark. Do this on both sides of the vehicle.



15. Slide the baseplate onto the frame, line the back of the baseplate with the mark. On the driver side pin to the existing hole in the frame (left). On the passenger side install the washer reservoir bolt into the existing hole (right). Level the baseplate and clamp it to the frame.

BX2407
2012-14 Dodge Challenger
Installation Instructions

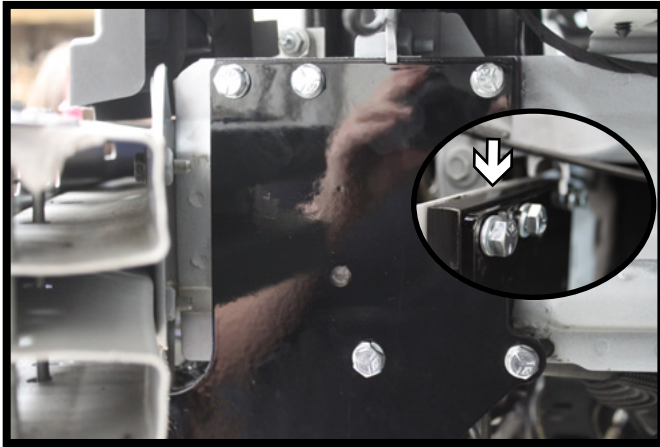

16. Using a 13/32" drill bit, drill the top three (3) holes and bottom two (2) holes into the frame. Install a 3/8"-16 x 1-3/4" bolt, 3/8" lock washer and 3/8"-16 nut into the each of the holes. On the top holes use the spacer plate between the frame and baseplate. Tighten down all fasteners. Do this on both sides of the vehicle.

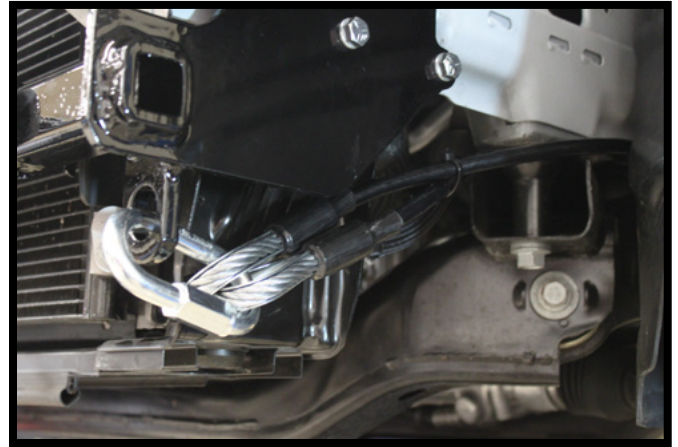

17. Attach the permanent baseplate safety cables to the provided convenience link on the baseplate. The photo above shows the recommended installation of the cables to frame of vehicle. Additional options may interfere with suggested mounting; in this case, secure the cables to a solid piece of the frame as described in the instructions included with the permanent baseplate safety cables. Be sure the safety cables do not rub against any hoses or moving parts. Do this on **BOTH** sides of the vehicle.

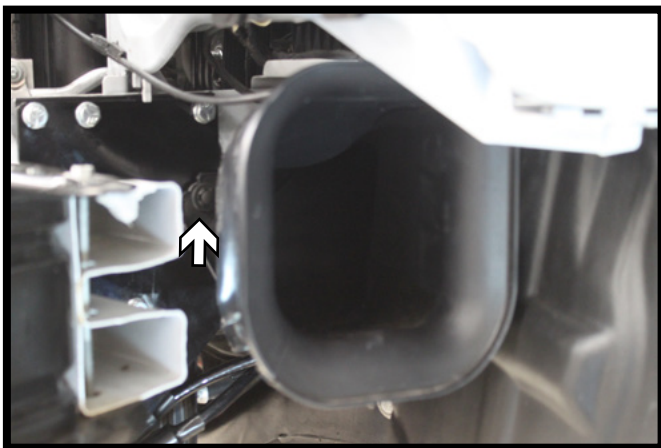

18. Reinstall the air baffle, using the existing hole thru the baseplate.

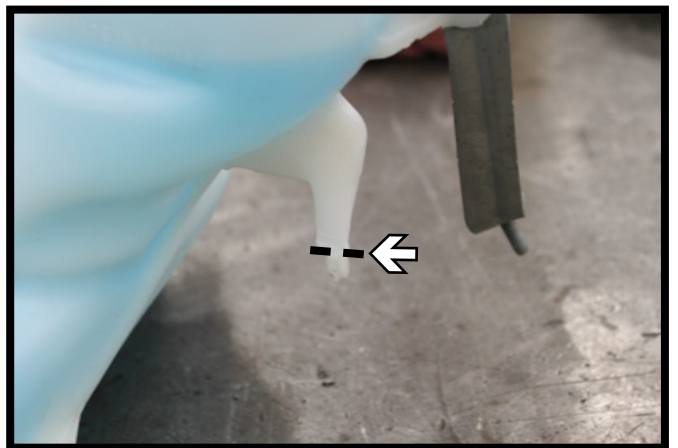

19. Trim the plastic peg off the washer reservoir. Reinstall the reservoir with the supplied 6MM bolts and spacers. Reattach the power steering pump.

BX2407
2012-14 Dodge Challenger
Installation Instructions



20. Before reinstalling the fascia, remove the plastic sheilding from both sides by removing the plastic rivets.



21. Hold the fascia as close to it's original position, mark and trim the lower grille as needed for baseplate clearance. Reinstall the plastic fascia support, fascia and underside shielding.

CUSTOMER SERVICE COMMITMENT

Blue Ox® is committed to providing you with exceptional customer care throughout your lifetime with our products. Our team is here to assist you with any questions you may have regarding the performance of your product. Simply call (402) 385-3051 and you can speak with our customer care team.

Additionally, please visit our website to see which rallies our Destination America team will be attending. For a nominal fee, our service technician will service your towing system to ensure it's in proper working condition. Also, as a commitment to our customers, should you visit our factory, you can stay at our full service Blue Ox® campground at no charge along with enjoying a factory tour.

Again, thank you for being our customer and for the confidence you have shown in the performance of our products. It is because of customers like you we enjoy the success we have today.

© 2013 Blue Ox
One Mill Road, Industrial Park
Pender, Nebraska 68047
Phone: (402) 385-3051
Fax: (402) 385-3360
www.blueox.com