



**BLUE OX®**

# BX2604

## 2009-12 Ford Flex SEL (No Ecoboost) 2011-12 Ford Flex Limited (No Ecoboost) Installation Instructions

**Please read BOTH these Installation Instructions and the General Instructions before attempting to install or operate this equipment.**

**Serial Number**

- Blue Ox® towing products and accessories are intended to be installed by Blue Ox® Dealers who are familiar with our products and have the equipment necessary and knowledge to do “fit work”. When necessary Blue Ox® Dealers can be found at [www.blueox.com](http://www.blueox.com) or by contacting our Customer Care Department at (402) 385-3051.
- Many Blue Ox® baseplates are designed to use existing holes and hardware to mount the baseplate to the towed vehicle. Even though bolts are there, do not assume they are adequate for baseplate mounting. Always use hardware supplied in the hardware kit and existing hardware specified in the Baseplate Installation Instructions.

Attachment Tab Height: 24 3/4”  
Attachment Tab Width: 24”

**Bolt Torque Specifications**  
Torque in Foot-Pounds for Metric Bolts

Bolt Size	Grade 8.8	Grade 10.9
6MM	6	8
8MM	16	22
10MM	31	40
12MM	54	70
14MM	89	117

**Confirm the towability and pre-towing procedures for your vehicle with the owner’s manual or contact the vehicle’s manufacturer for specific towing procedures.**

**Do not use the towed vehicle for storing luggage, equipment, etc. This may cause you to exceed the towing capacity of the tow bar, baseplate, and its accessories.**

**Bolt Torque Specifications**  
Torque in Foot-Pounds for Inch Bolts

Bolt Size	Grade 5	Grade 8
1/4”	10	14
5/16”	19	29
3/8”	33	47
7/16”	54	78
1/2”	78	119
5/8”	154	230



**If the front of your vehicle looks different than this, call us at (402) 385-3051.**

**⚠ WARNING**

Failure to read and follow these instructions could result in separation of the towed vehicle from the tow bar, causing property damage, loss of towed vehicle, personal injury or death.

**BX2604**  
**2009-12 Ford Flex SEL (No Ecoboost)**  
**2011-12 Ford Flex Limited (No Ecoboost)**  
**Installation Instructions**

<b>Parts List</b>			
Ref. No.	Qty.	Part #	Description
1	1	61-6581	BX2604 Baseplate
2	2	61-5367	Nut Plate Weldment
3	2	201-0443	3/8"-16 x 1" Hex Bolt, Grd.5, ZP
4	6	201-0368	3/8"-16 x 1-1/4" Hex, Grd. 5, ZP
5	4	203-0003	3/8" Flat Washer, ZP
6	2	203-0010	3/8" Lock Washer, ZP
7	6	202-0090	3/8"-16 Hex Nyl. Ins. Lock Nut, ZP
8	2	201-0979	#12-14 x 1" Self Drilling Screw, ZP
9	2	201-0192	#10-32 x 1/2" Slotted Round Head Screw
10	2	203-0054	#10 Lock Washer
11	2	202-0047	#10-32 Hex Nut
12	2	101-5822	4 Way Connector Adapter
13	2	62-3469	Attachment Tab Assembly
	2	226-0046	36" CL III Safety Cable (not shown)
	2	229-0359	3/8" Quicklink, ZP (not shown)
	2	290-0437	Black Cap Plug (not shown)

<b>Tools Required</b>	
5.5MM Socket	Flat Screw Driver
7MM Socket	Phillips Screwdriver
10MM Socket	Utility Knife
13MM Socket	Hacksaw Blade
9/16" Socket/Wrench	Drill
Large Vise Grips	1/4" Drill Bit
Reciprocating Saw	13/32" Drill Bit
Loctite® RED	

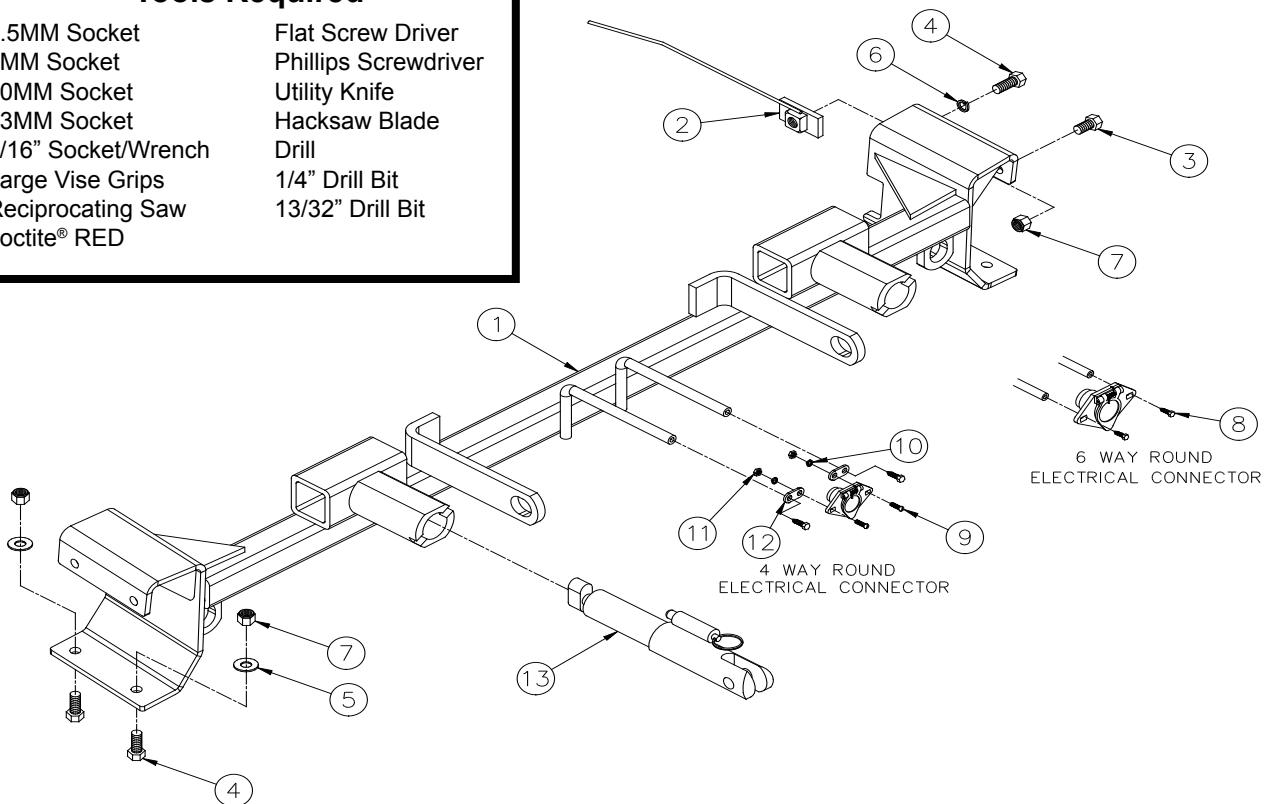

**Important:**

Use only genuine factory replacement parts on your baseplate. Do **NOT** substitute homemade or non-typical parts. If a bolt is lost or in need of replacement, for your safety and the preservation of your baseplate, be sure to use a replacement bolt of the same grade (In most cases it will be Grade 5, please reference the parts list above). Replacement parts may be ordered through your nearest Blue Ox® Dealer or Distributor. Failing to follow and/or altering these installation instructions in either installation or required equipment will void the manufacturer's warranty. Towing behind a non-motorized vehicle will void the warranty.

BX2604  
2009-12 Ford Flex SEL (No EcoBoost)  
2011-12 Ford Flex Limited (No EcoBoost)  
Installation Instructions

**Attachment Tabs:** Due to the design of the removable tabs, the RangeFinderII tow bar can not be used. Adapters, except the BX8833 and BX88151, can not be used with this baseplate.

**Installation Notes:** The front fascia, metal bumper and headlights are removed and replaced during installation. Drilling is required. The grille must be trimmed.

The dimensional variations between otherwise identical vehicles can be considerable. While the baseplate was designed for easy installation, it may be necessary to tailor the baseplate slightly to compensate for auto manufacturer's tolerances. These minor adjustments may include filing a hole slightly, bending electrical rods or bending end plates.

The BX8869 Bulb and Socket Wiring Kit is recommended for this vehicle.

Notice: Do not use BX8869 or BX8848 with models that have LED tail lights. BX8834 is the only application that will work with LED tail lights.

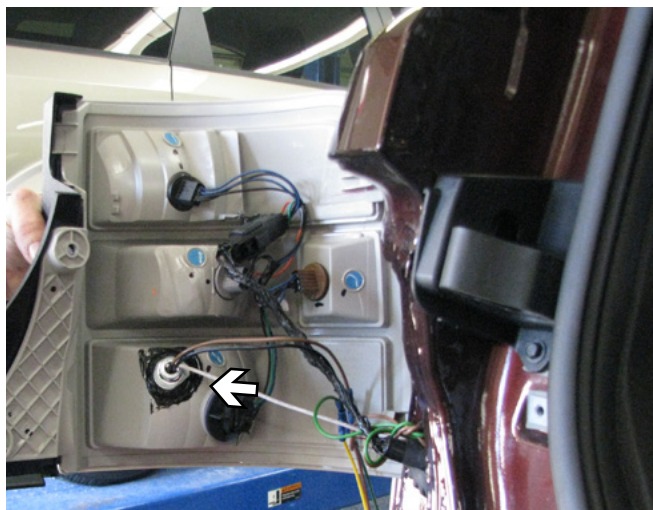

**Handling of some cosmetic parts when installing this product may require the use of protective covers, rags, specialty tools, etc. to prevent damage.**

**Do not use the towed vehicle for storing luggage, equipment, etc. This may cause you to exceed the towing capacity of the tow bar, baseplate, and its accessories.**

### Installation Instructions:



1. Using the 10MM socket, remove the metric bolts from the top corners of the grille (white arrows). Remove two (2) pushpins from the top of the grille (gray arrows). Do this to both sides of the vehicle. Set bolts and pushpins aside to be reinstalled later.

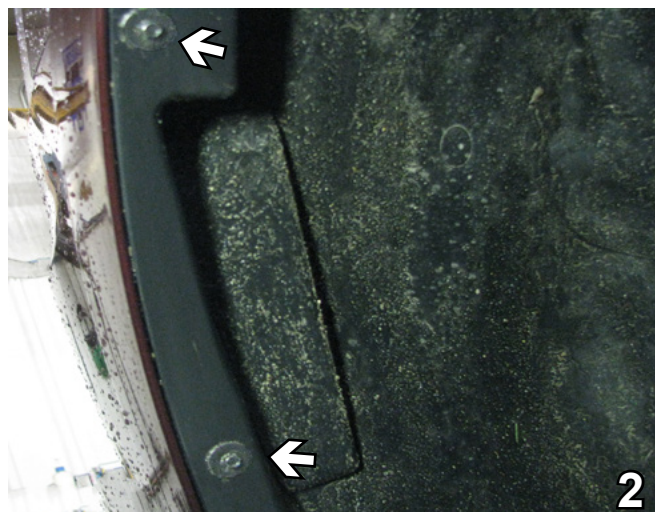

2. Just forward of the front tire, inside the wheel well, using 5.5MM socket remove three screws. Do this to both sides of the vehicle. Set screws aside to be reinstalled later.

BX2604  
2009-12 Ford Flex SEL (No Ecoboost)  
2011-12 Ford Flex Limited (No Ecoboost)  
Installation Instructions



3. Remove the pushpin from the bottom edge of the fascia just forward of the front tire. Do this to both sides of the vehicle. Set pushpin aside to be reinstalled later.

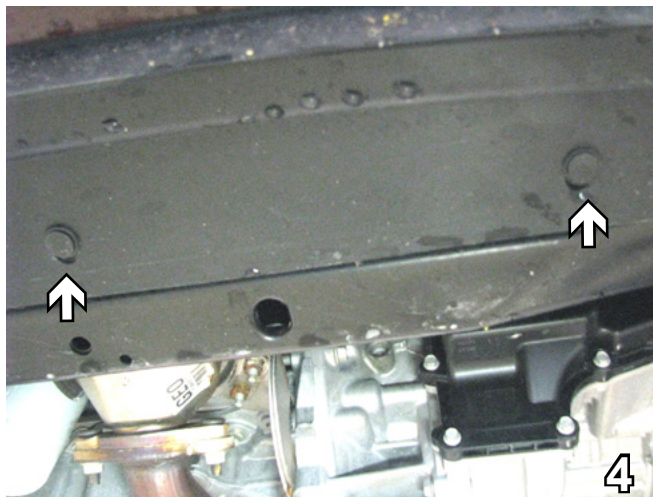

4. Remove three (3) pushpins from underneath the center of the fascia. Set pushpins aside to be reinstalled later.

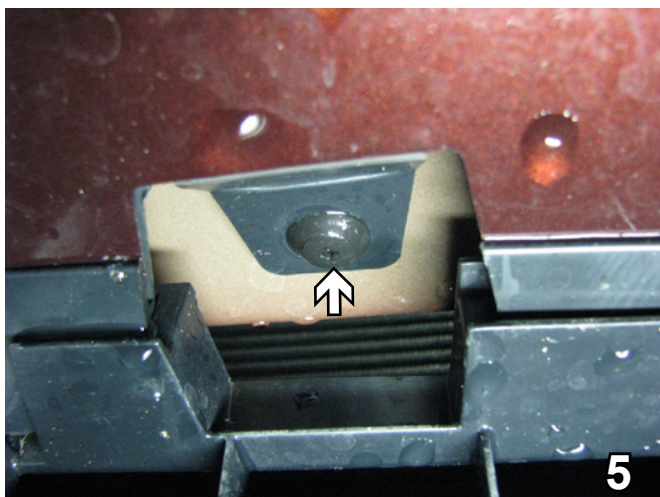

5. Using the Phillips screwdriver, remove one (1) pushpin from the front of the fascia, one (1) per side. Pull fascia forward to remove it. Set fascia and pushpins aside carefully to be reinstalled later.

6. Remove three (3) pushpins, two (2) on top and one (1) underneath, from the plastic guard on top of the bumper. Do this to both sides of the vehicle. Set guard and pushpins aside to be reinstalled later.

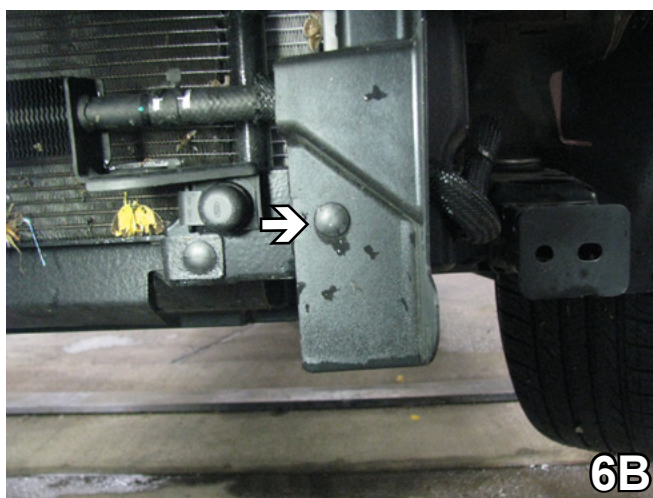
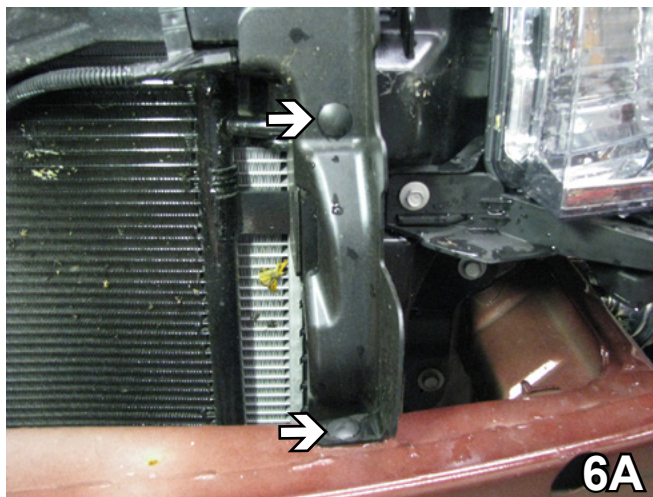

BX2604  
2009-12 Ford Flex SEL (No Ecoboost)  
2011-12 Ford Flex Limited (No Ecoboost)  
Installation Instructions

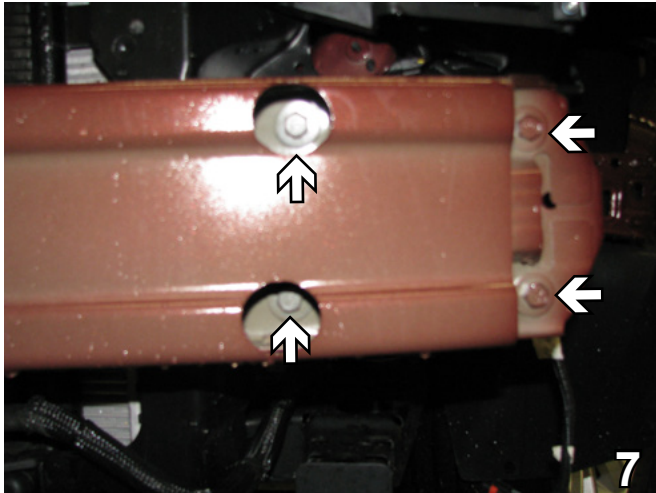

7. Using the 13MM socket, remove four (4) metric bolts from the bumper, two (2) per side. Set the bolts aside to be reinstalled later.

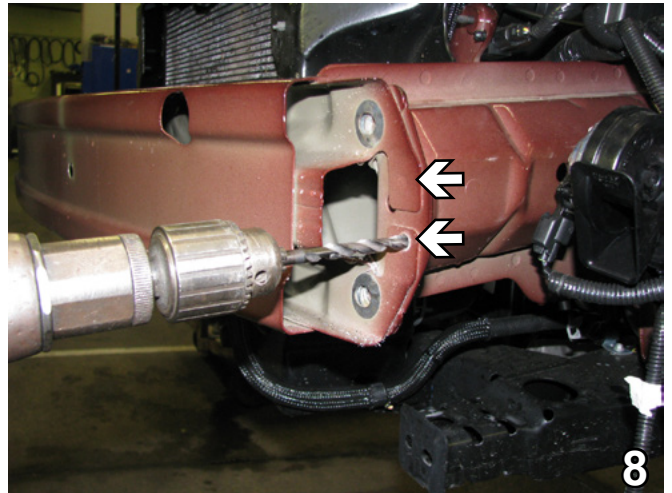

8. Using the 1/4" drill bit, drill out the two (2) spot welds on each side. Remove the bumper and set aside to be reinstalled later.

When using power drills be aware of the dangers of torque and drill bit length.

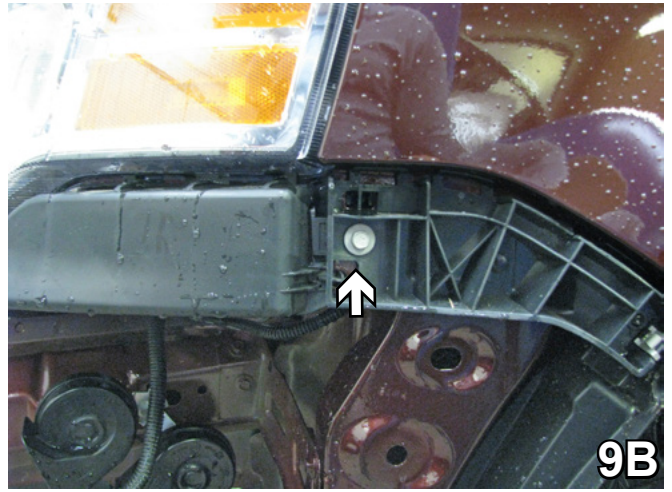

9. Using the 10MM socket, remove four (4) metric bolts from the headlight, one (1) per side, two (2) on the top and remove a push pin on the top (gray arrow). Unplug, remove the headlight and set aside to be reinstalled later. Do this to both sides of the vehicle.

BX2604  
2009-12 Ford Flex SEL (No Ecoboost)  
2011-12 Ford Flex Limited (No Ecoboost)  
Installation Instructions

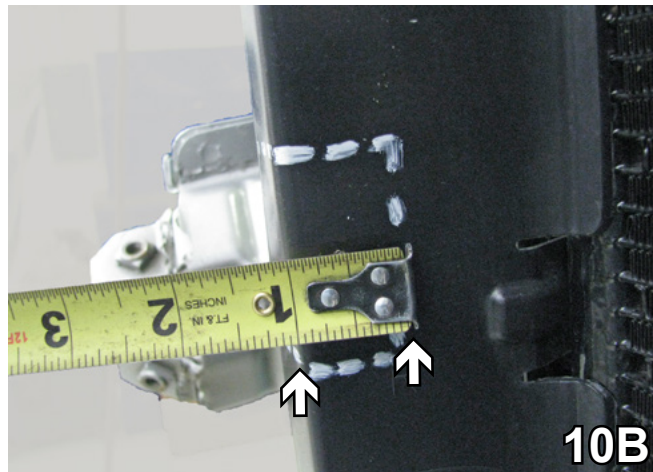
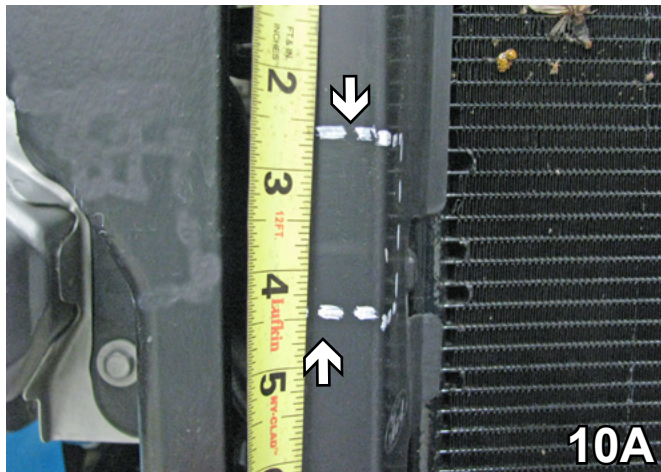

10. **2010 Model:** On the passenger side only, trim an opening which is down 2-1/2" to 4-1/2" and 1" in.

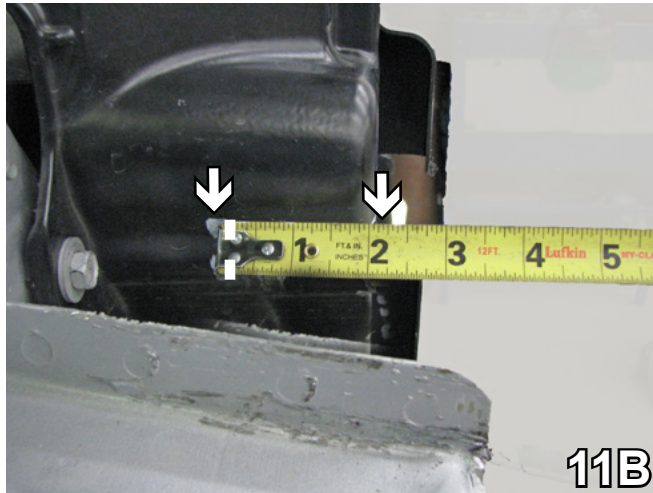
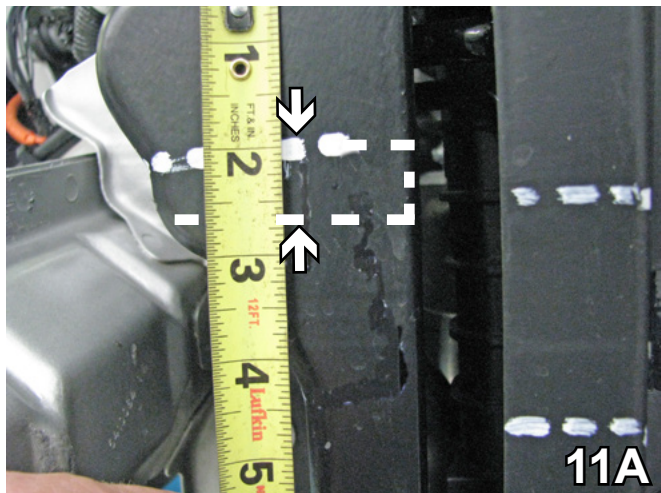

11. **2010 Model:** Continuing on the passenger side next to the previous opening, trim an opening which is down 2" to 2-1/2". Start at the bend go straight across and in 2" on the left side.

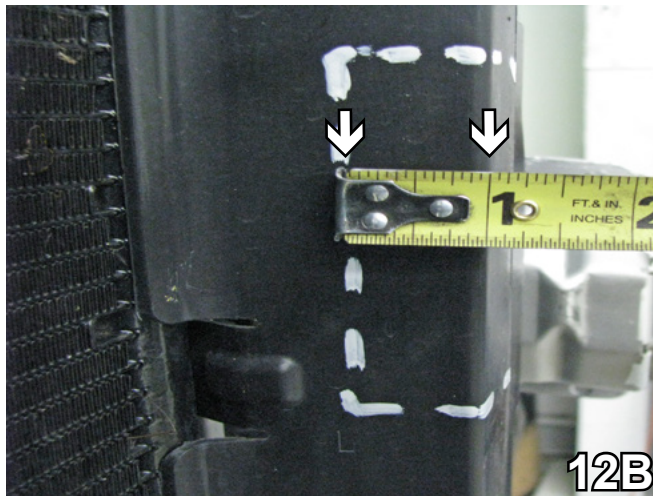
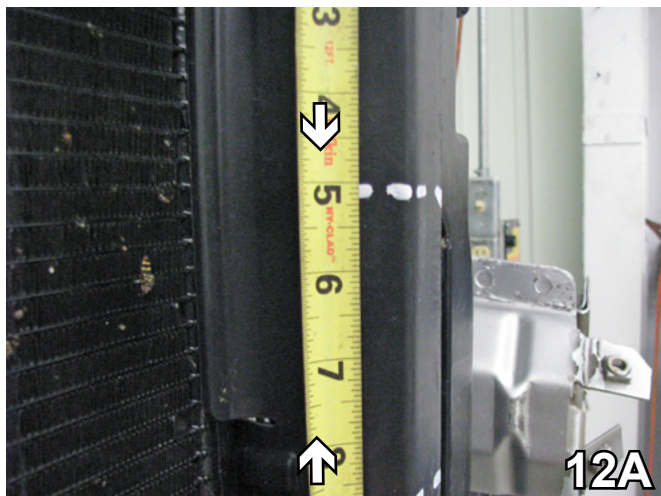

12. **2010 Model:** On the driver side, trim an opening in the plastic which is 5" down to 9" and in 1".

BX2604  
 2009-12 Ford Flex SEL (No Ecoboost)  
 2011-12 Ford Flex Limited (No Ecoboost)  
 Installation Instructions

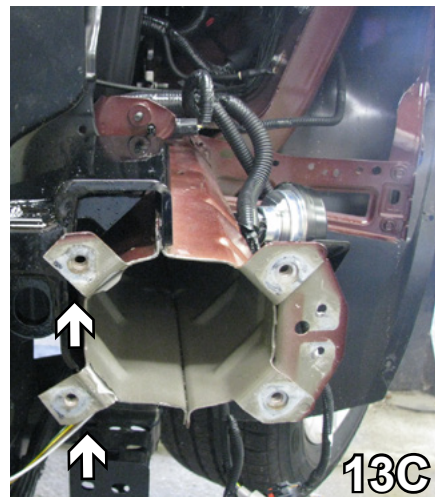
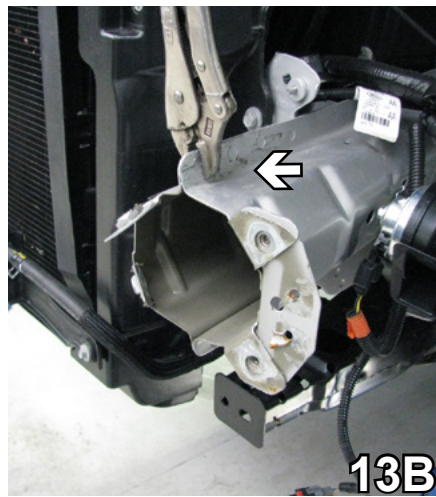
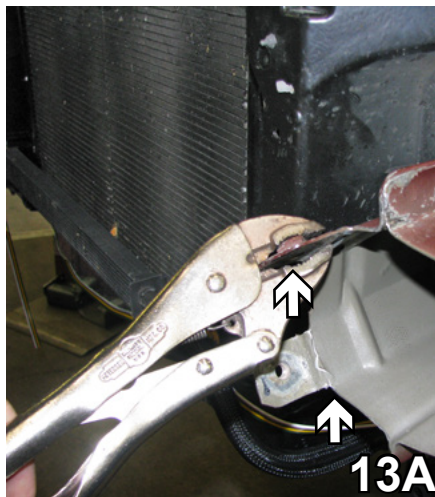

13. Using the vise grip, bend the two (2) inside tabs out flat with the frame. On top of the frame rail, bend the center ribbing toward the radiator (about 6" back from the end). Slide the baseplate up on. Insure the baseplate is level with respect to the vehicle frame. Bend the tabs back (13A). Do this to both sides of the vehicle.

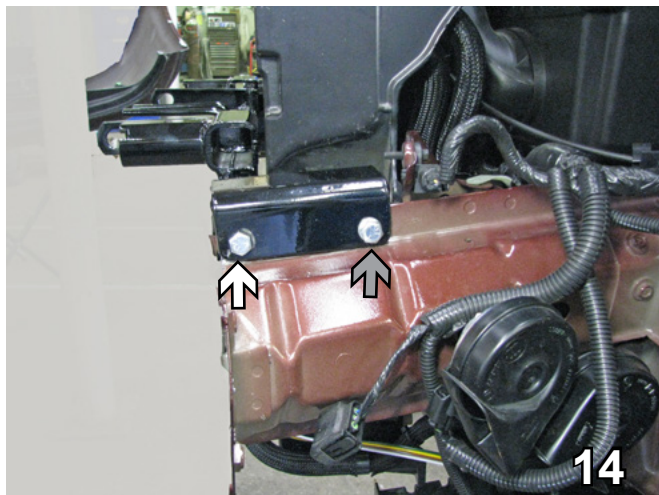

14. Using the baseplate as a template, drill holes with the 13/32" drill bit. Attach 3/8"-16 x 1" bolt to 3/8" nylon insert nut in the front hole (white arrow). In the back hole (gray arrow), use 3/8"-16 x 1-1/4" bolt and 3/8" lock washer with 3/8" nut plate. Use Loctite Red®. Do this to both sides of the vehicle. Photos show driver's side.

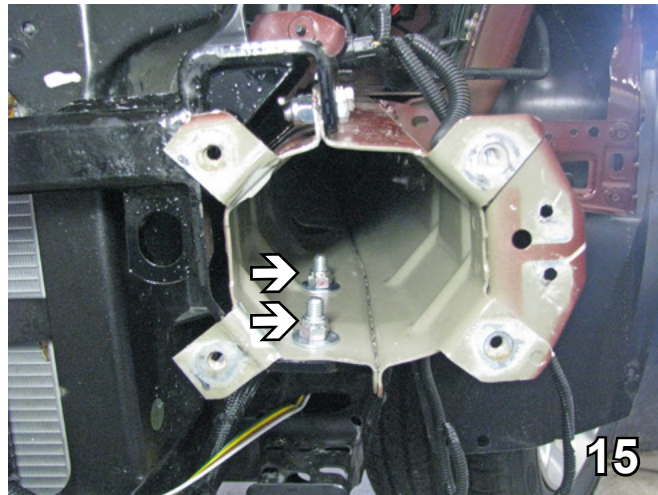

15. On the bottom use 3/8"-16 x 1-1/4" bolts with 3/8" flat washers and 3/8" nylon insert nuts. Use Loctite Red®. Do this to both sides of the vehicle. Reinstall the bumper.

When using power drills be aware of the dangers of torque and drill bit length.

**BE SURE TO USE LOCTITE® RED ON ALL BOLTS BEFORE TIGHTENING. TIGHTEN ALL BOLTS ACCORDING TO THE TORQUE CHART ON THE FRONT PAGE OF THESE INSTRUCTIONS OR ON PAGE 3 OF THE BASEPLATE TOWING GENERAL INSTRUCTIONS.**

16. Reinstall headlights. Insure all pushpins, bolts, and electrical connections are installed.

BX2604  
2009-12 Ford Flex SEL (No EcoBoost)  
2011-12 Ford Flex Limited (No EcoBoost)  
Installation Instructions

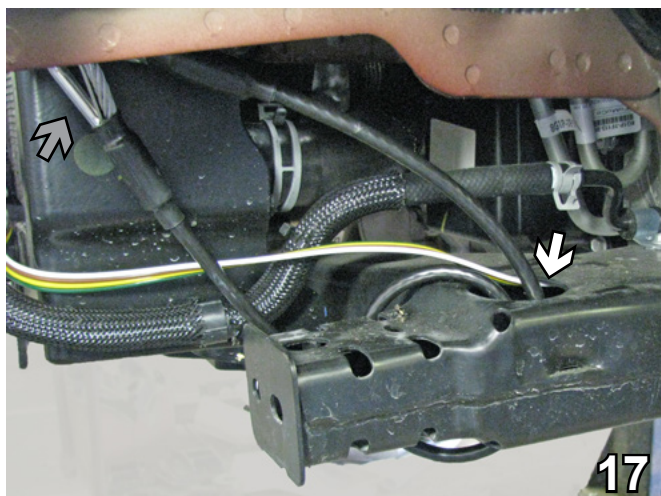

17. Attach the permanent baseplate safety cables to the provided convenience link on the baseplate (see grey arrow). The photo above shows the recommended installation of the cables to frame of vehicle (see white arrow). Additional options may interfere with suggested mounting; in this case secure the cables to a solid piece of the frame as described in the instructions included with the permanent baseplate safety cables. Be sure the safety cables do not rub against any hoses or moving parts. Do this to both sides of the vehicle.

Be sure that **ALL** electrical connections are plugged in properly and functioning **BEFORE** installing the fascia.



18. Before installing the electrical plug, hold the fascia up to its original location, cut out the horizontal style with the hacksaw blade as necessary for the attachment tabs to come through. Do this to both sides of the vehicle. Reinstall the fascia.

**DEALER or INSTALLER:**  
Be certain the user receives the instruction sheets for their products.



19. Install the electrical plug on the front of the fascia.

Install the tow bar and safety cables according to the instructions provided in their packages. When demonstrating this to the customer, be sure to include all the contents and packages.

Do **NOT** substitute other devices if the tow bar pins and clips are misplaced.



BX2604  
2009-12 Ford Flex SEL (No Ecoboost)  
2011-12 Ford Flex Limited (No Ecoboost)  
Installation Instructions



Shown without removable tabs installed



Shown with removable tabs installed

### CUSTOMER SERVICE COMMITMENT

Blue Ox is committed to providing you with exceptional customer care throughout your lifetime with our products. Our team is here to assist you with any questions you may have regarding the performance of your product. Simply call (402) 385-3051 and you can speak with our customer care team.

Additionally, please visit our website to see which rallies our Destination America team will be attending. For a nominal fee, our service technician will service your towing system to ensure it's in proper working condition. Also, as a commitment to our customers, should you visit our factory, you can stay at our full service Blue Ox campground at no charge along with enjoying a factory tour.

Again, thank you for being our customer and for the confidence you have shown in the performance of our products. It is because of customers like you we enjoy the success we have today.

**If the baseplate is in an accident, it must be replaced. DO NOT use it again! An accident can cause unseen damage and using it again could result in more damage or serious injury. DO NOT use the baseplate if it is damaged or missing parts.**

© 2011 Blue Ox  
One Mill Road, Industrial Park  
Pender, Nebraska 68047  
Phone: (402) 385-3051  
Fax: (402) 385-3360  
[www.blueox.com](http://www.blueox.com)