



BX2605

2009-12 Ford Escape 2009-12 Mercury Mariner (Includes Hybrid) Installation Instructions

Serial Number

Please read BOTH these Installation Instructions and the General Instructions before attempting to install or operate this equipment.

- Blue Ox® towing products and accessories are intended to be installed by Blue Ox® Dealers who are familiar with our products and have the equipment necessary and knowledge to do “fit work”. When necessary Blue Ox® Dealers can be found at www.blueox.com or by contacting our Customer Care Department at (402) 385-3051.
- Many Blue Ox® baseplates are designed to use existing holes and hardware to mount the baseplate to the towed vehicle. Even though bolts are there, do not assume they are adequate for baseplate mounting. Always use hardware supplied in the hardware kit and existing hardware specified in the Baseplate Installation Instructions.

Attachment Tab Height: 17”

Attachment Tab Width: 22”

Bolt Torque Specifications		
Torque in Foot-Pounds for Metric Bolts		
Bolt Size	Grade 8.8	Grade 10.9
6MM	6	8
8MM	16	22
10MM	31	40
12MM	54	70
14MM	89	117

Confirm the towability and pre-towing procedures for your vehicle with the owner’s manual or contact the vehicle’s manufacturer for specific towing procedures.

Bolt Torque Specifications		
Torque in Foot-Pounds for Inch Bolts		
Bolt Size	Grade 5	Grade 8
1/4”	10	14
5/16”	19	29
3/8”	33	47
7/16”	54	78
1/2”	78	119
5/8”	154	230



If the front of your vehicle looks different than this, call us at (402) 385-3051.

WARNING

Failure to read and follow these instructions could result in separation of the towed vehicle from the tow bar, causing property damage, loss of towed vehicle, personal injury or death.

BX2605
2009-12 Ford Escape
2009-12 Mercury Mariner
(Includes Hybrid)
Installation Instructions

Parts List

Ref. No.	Qty.	Part #	Description
1	1	61-6586	Wldm't, BP, BX2605
2	4	107-2683	Spacer Tube, 3/4 X .406 (ID) X 1"
3	8	201-0518	10MM-1.5 X 40MM Hex Bit, GR 10.9, ZP
4	4	201-0428	10MM-1.5 X 50MM Hex Bolt Grd.8.8 ZP
5	12	203-0104	10MM Lock Washer, ZP
6	4	203-0003	3/8 Flat Washer, ZP
7	4	201-0440	3/8-16 X 1 1/2 Hex Bolt, Grd.5, ZP
8	4	201-0332	3/8-16 X 2 1/4 Hex Bolt Grade 5 ZP.
9	8	203-0010	3/8 Lock Washer, ZP
10	8	61-5208	Wld, Nut Plt 1/4X1X1, 3/8" with 14"Wire
11	2	201-0979	#12-14 x 1" Self Drilling Screw, ZP
12	2	201-0192	10-32 X 1/2 Slot, RD. HD. Screw
13	2	203-0054	#10 Lock Washer
14	2	202-0047	#10-32 Hex Nut
15	2	101-5822	Adapter, 4 Way Connector
16	2	62-3468	Att Tab Assy, Rem, SF/SB, 1 Hole
	2	226-0046	Baseplate Safety Cable, 36" CL III (Not Shown)
	2	229-0359	Quicklink, 3/8, ZP (Not Shown)
	2	290-0437	Cap Plug, Black (Not Shown)

Tools Required

10MM Socket	Large Vise Grip
13MM Socket	Reciprocating Saw
17MM Socket	Drill
9/16" Socket & Wrench	5/8" Socket
Flat Screwdriver	Loctite® RED
13/32" Drill Bit	

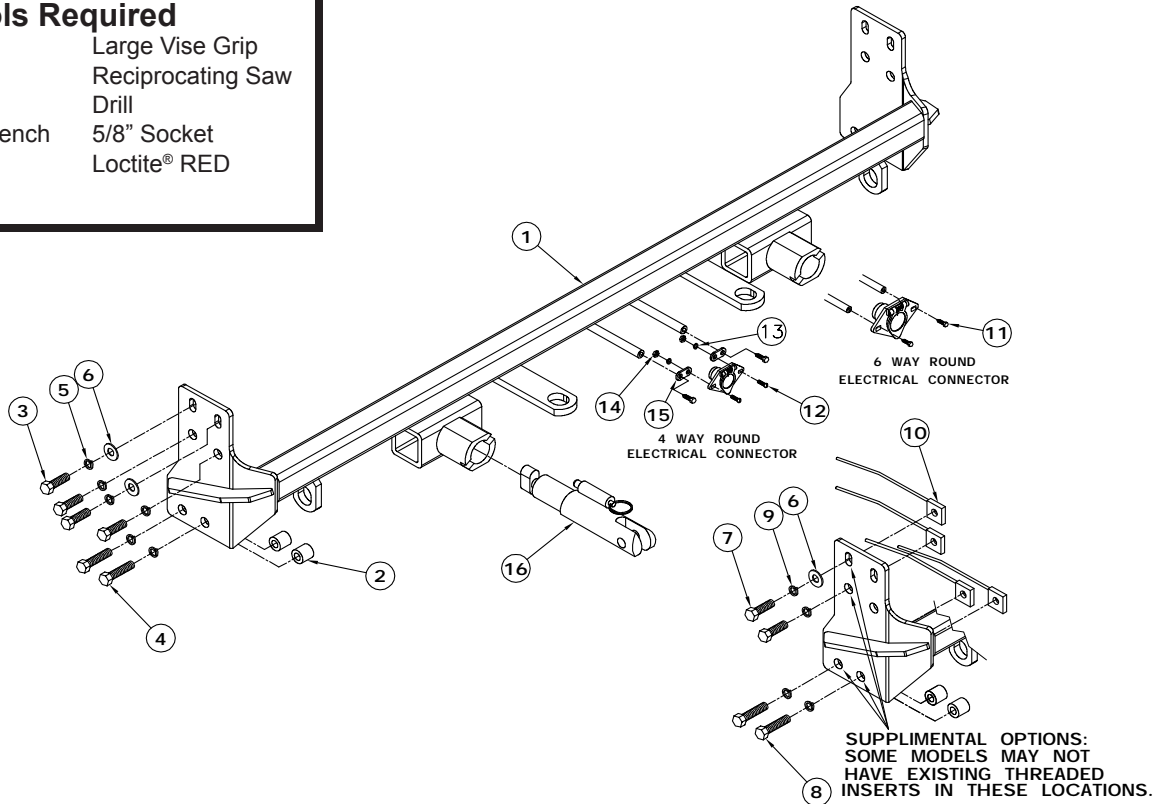

Important:

Use only genuine factory replacement parts on your baseplate. Do **NOT** substitute homemade or non-typical parts. If a bolt is lost or in need of replacement, for your safety and the preservation of your baseplate, be sure to use a replacement bolt of the same grade (In most cases it will be Grade 5, please reference the parts list above). Replacement parts may be ordered through your nearest Blue Ox® Dealer or Distributor. Failing to follow and/or altering these installation instructions in either installation or required equipment will void the manufacturer's warranty.

BX2605
2009-12 Ford Escape
2009-12 Mercury Mariner
(Includes Hybrid)
Installation Instructions

Attachment Tabs: Due to the design of the removable tabs, the RangeFinder II, Acclaim and Ambassador tow bars can not be used. Adapters, except the BX8833 and BX88151, can not be used with this baseplate.

Installation Notes: The fascia, air dam, air temperature gauge and bumper are removed and replaced during installation. The air dam and the air temperature gauge must be trimmed.

The dimensional variations between otherwise identical vehicles can be considerable. While the baseplate was designed for easy installation, it may be necessary to tailor the baseplate slightly to compensate for auto manufacturer's tolerances. These minor adjustments may include filing a hole slightly, bending electrical rods or bending end plates.

The BX8869 Bulb and Socket Wiring Kit is recommended for this vehicle.

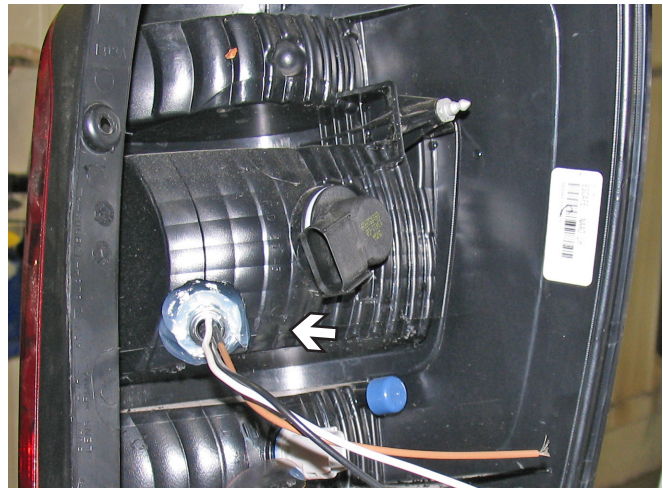

Possible location for the Bulb and Socket Wiring Kit (BX8869)

Do not use the towed vehicle for storing luggage, equipment, etc. This may cause you to exceed the towing capacity of the tow bar, baseplate, and its accessories.

Handling of some cosmetic parts when installing this product may require the use of protective covers, rags, specialty tools, etc. to prevent damage.

Installation Instructions



1. Using the 10MM socket, remove the metric bolts from the top corners of the grille. Do this to both sides of the vehicle. Set bolts aside to be reinstalled later.



2. Just forward of the front tire, inside the wheel well, remove three (3) pushpins. Do this to both sides of the vehicle. Set pushpins aside to be reinstalled later.

BX2605
2009-12 Ford Escape
2009-12 Mercury Mariner
(Includes Hybrid)
Installation Instructions



3. Remove the pushpin from the front under the bottom opening. Do this to both sides of the vehicle. Set pushpins aside to be reinstalled later.

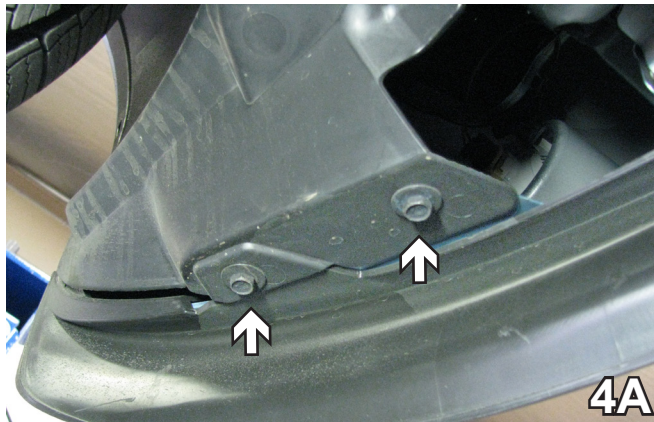

4. Using a 10MM socket, remove the seven (7) bolts from underneath the fascia, two (2) per side, one (1) in the middle and one (1) in between on both sides. Set bolts aside to be reinstalled later.

BX2605
2009-12 Ford Escape
2009-12 Mercury Mariner
(Includes Hybrid)
Installation Instructions

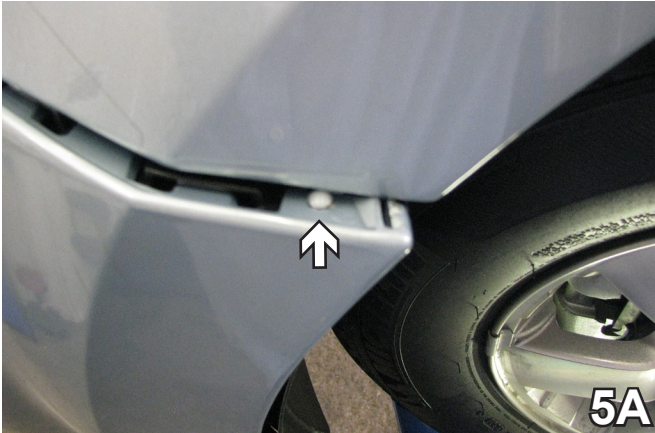

5. Pull front of fascia out until the white pin is visible. Remove the white pin and continue to pull the fascia forward to the second white pin is visible and remove it also. Set fascia and pins aside carefully to be reinstalled later.

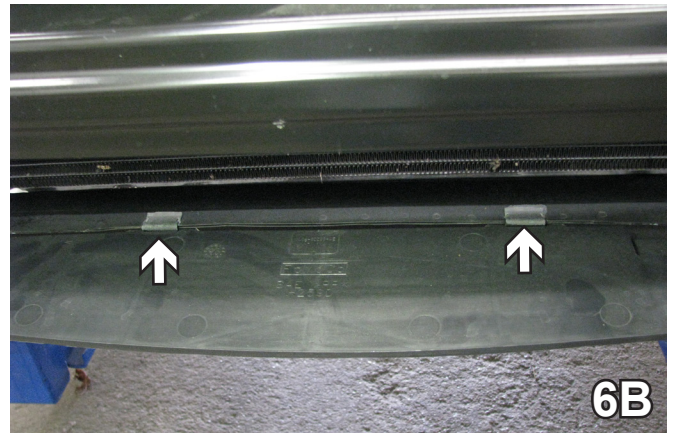
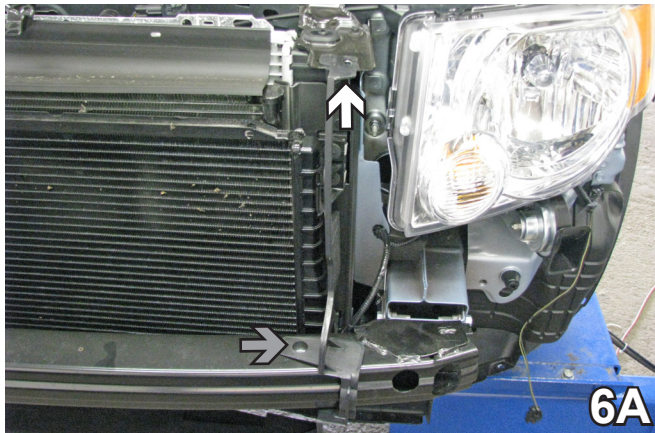

6. To remove the air dam, lift the brace up over the catch at the top (white arrow). Then remove the push pin on the bumper (gray arrow). Do this to both sides of the vehicle. On the air dam itself, take off the clips (photo 6B). Then remove the air dam as one piece, set air dam, pushpins and clips aside to be reinstalled later.

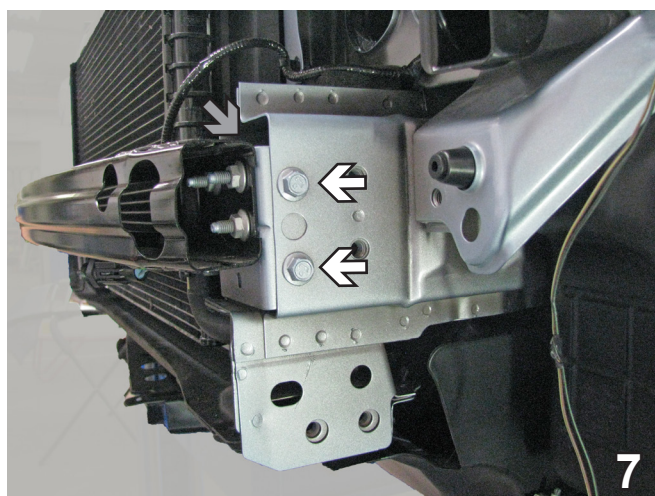

7. Using the 13MM socket, remove two (2) metric bolts on each side. Do this to both sides of the vehicle. **NOTE: If the vehicle has tow hooks, they will be removed and not reattached. Gray arrow shows location to insert nut plate if needed (see note step 9).**

BX2605
2009-12 Ford Escape
2009-12 Mercury Mariner
(Includes Hybrid)
Installation Instructions

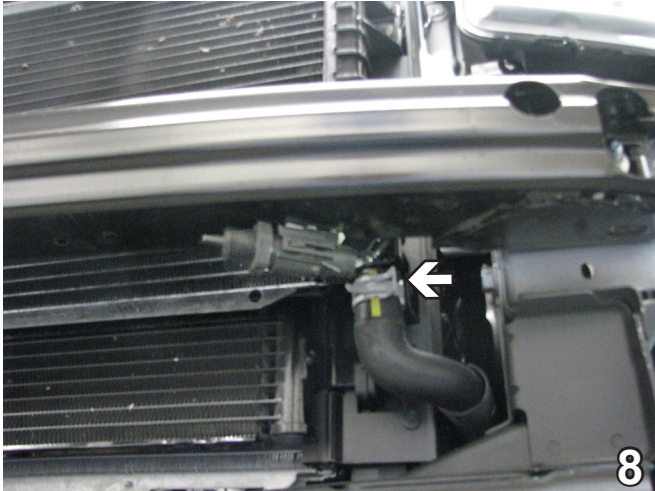

8. Remove the temperature gauge. It will be relocated when it is reinstalled.

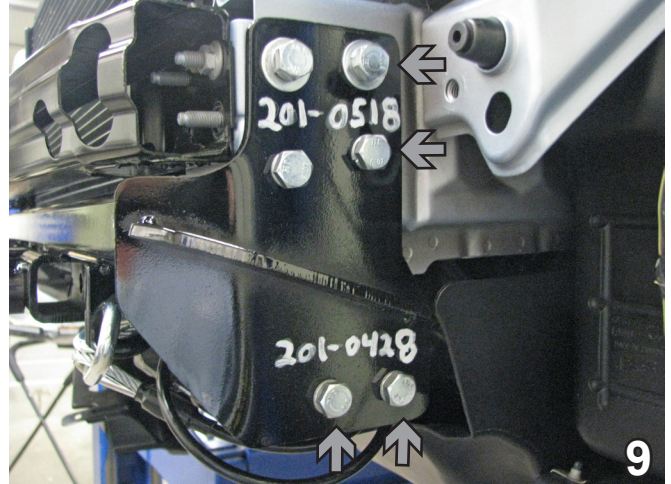

9. Slide the baseplate straight on. Insure the baseplate is level with the frame. Attach 40MM hex bolts in the top four (4) holes with 10MM lock washers and in the top two (2) holes also use 3/8" flat washers. In the bottom two (2) holes, attach 50MM hex bolts with 10MM lock washers. Do this to both sides of the vehicle. **NOTE: See supplemental option on drawing on page 2, for vehicles that may not have thread inserts (see grey arrows).** The gray arrow in step 10 is the location to drill hole with 1-1/4" hole saw, to access the inside of frame for lower nut plates.

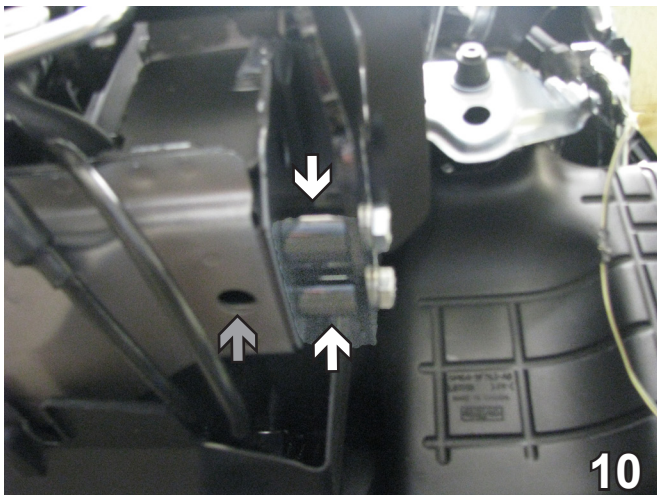

10. Using spacers between the frame and the baseplate on the bottom two (2) holes. Do this to both sides of the vehicle. Reinstall the bumper.

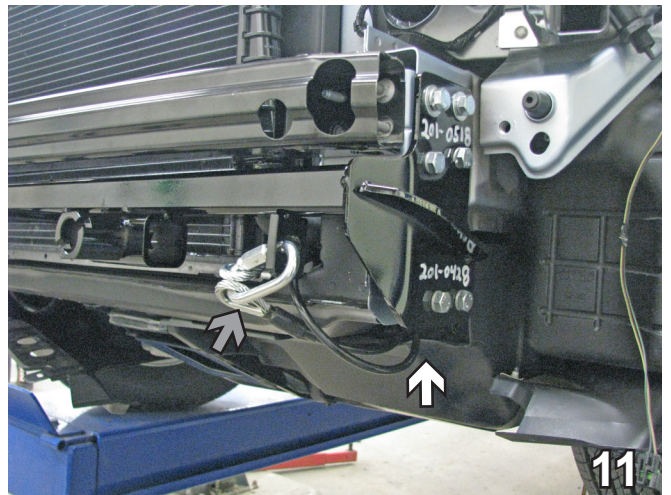

11. Attach the permanent baseplate safety cables to the provided convenience link on the baseplate (see grey arrow). The photo above shows the recommended installation of the permanent baseplate safety cables to frame of the vehicle (see white arrow). Additional options may interfere with suggested mounting, in this case secure the cable to a solid piece of the frame as described in the instructions included with the permanent baseplate safety cables. Be sure the safety cables do not rub against any hoses or moving parts. Do this to both sides of the vehicle.

BX2605
2009-12 Ford Escape
2009-12 Mercury Mariner
(Includes Hybrid)
Installation Instructions



12. Put the air dam back on, slide the two (2) clips in. Hold the brace piece up and mark it in order to trim it to fit. Do this to both sides of the vehicle.

13. Cut off the circle tab at the end of the air temperature gauge.

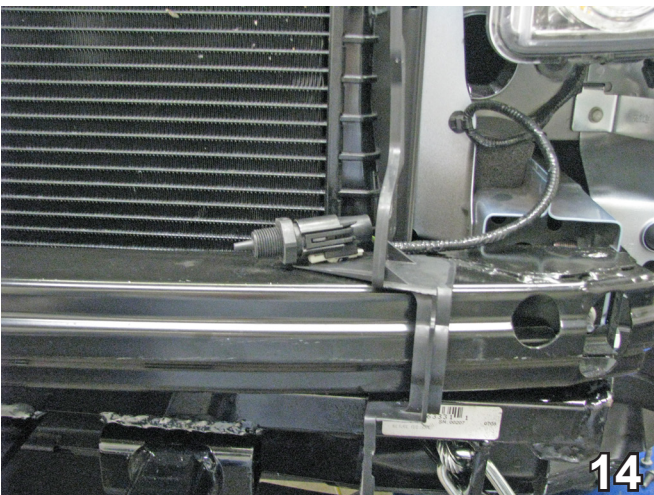
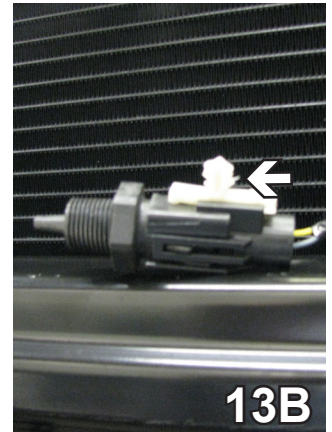
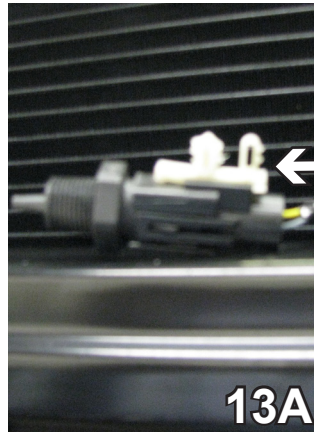

14. Reattach the air temperature gauge as shown. Reinstall the fascia.

Install the tow bar and safety cables according to the instructions provided in their packages. When demonstrating this to the customer, be sure to include all the contents and packages.

Do **NOT** substitute other devices if the tow bar pins and clips are misplaced.

BE SURE TO USE LOCTITE® RED ON ALL BOLTS BEFORE TIGHTENING. TIGHTEN ALL BOLTS ACCORDING TO THE TORQUE CHART ON THE FRONT PAGE OF THESE INSTRUCTIONS OR ON PAGE 3 OF THE BASEPLATE TOWING GENERAL INSTRUCTIONS.

DEALER or INSTALLER:
Be certain the user receives the instruction sheets for their products.

Be sure that **ALL** electrical connections are plugged in properly and functioning **BEFORE** installing the fascia.

BX2605
2009-12 Ford Escape
2009-12 Mercury Mariner
(Includes Hybrid)
Installation Instructions



Shown without removable tabs installed



Shown with removable tabs installed

CUSTOMER SERVICE COMMITMENT

Blue Ox is committed to providing you with exceptional customer care throughout your lifetime with our products. Our team is here to assist you with any questions you may have regarding the performance of your product. Simply call (402) 385-3051 and you can speak with our customer care team.

Additionally, please visit our website to see which rallies our Destination America team will be attending. For a nominal fee, our service technician will service your towing system to ensure it's in proper working condition. Also, as a commitment to our customers, should you visit our factory, you can stay at our full service Blue Ox campground at no charge along with enjoying a factory tour.

Again, thank you for being our customer and for the confidence you have shown in the performance of our products. It is because of customers like you we enjoy the success we have today.

If the baseplate is in an accident, it must be replaced. DO NOT use it again! An accident can cause unseen damage and using it again could result in more damage or serious injury. DO NOT use the baseplate if it is damaged or missing parts.



© 2011 Blue Ox
One Mill Road, Industrial Park
Pender, Nebraska 68047
Phone: (402) 385-3051
Fax: (402) 385-3360
www.blueox.com