



BLUE OX

Baseplate Installation Instructions

BX2609

2005-08 Ford Escape, 2005-08 Ford Escape Hybrid. 2008 Mercury Mariner Installation Instructions

Serial Number

Please read BOTH these Installation Instructions and the General Towing Instructions before attempting to install or operate this equipment.

- Blue Ox® towing products and accessories are intended to be installed by Blue Ox® Dealers who are familiar with our products and have the equipment and knowledge to do “fit work.” When necessary, Blue Ox® Dealers can be found at www.blueox.com or by contacting our Customer Care Department at (402) 385-3051.
- Many Blue Ox® Baseplates are designed to use existing holes and hardware to mount the baseplate to the towed vehicle. Even though bolts are there, do not assume they are adequate for baseplate mounting. Always use hardware supplied in the hardware kit or existing hardware specified in the Baseplate Towing Installation Instructions.

Attachment Tab Height: 18 1/2”
Attachment Tab Width: 18”

Bolt Torque Specifications

Torque in Foot-Pounds for Metric Bolts

Bolt Size	Grade 8.8	Grade 10.9
6MM	6	8
8MM	16	22
10MM	31	40
12MM	54	70
14MM	89	117

Confirm the towability and pre-towing procedures for your vehicle with the owner’s manual or contact the vehicle’s manufacturer for specific towing procedures.

Bolt Torque Specifications

Torque in Foot-Pounds for Inch Bolts

Bolt Size	Grade 5	Grade 8
1/4”	10	14
5/16”	19	29
3/8”	33	47
7/16”	54	78
1/2”	78	119
5/8”	154	230

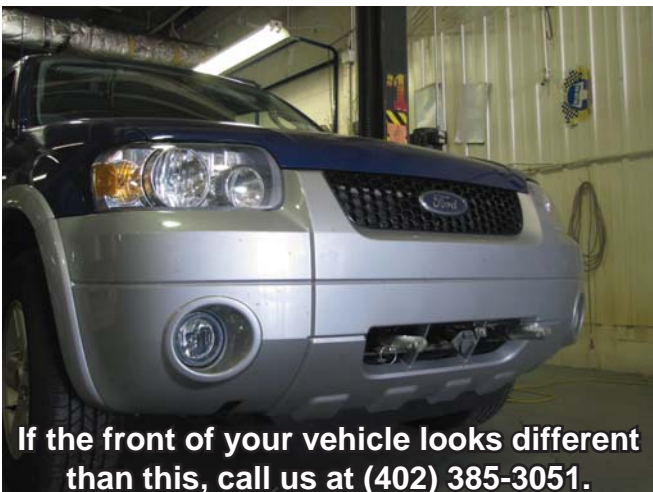

If the front of your vehicle looks different than this, call us at (402) 385-3051.

WARNING

Failure to read and follow these instructions could result in separation of the towed vehicle from the tow bar, causing property damage, loss of towed vehicle, personal injury or death.

BX2609 2005-08 Ford Escape, 2005-08 Ford Escape Hybrid, 2008 Mercury Mariner

Installation Instructions

Parts List

Ref. No.	Qty.	Part #	Description
1	1	61-6644	WLDM'T, BP, BX2609
2	4	107-2683	SPACER TUBE, 3/4 X .406 (ID) X 1"
3	8	201-0518	10MM-1.5 X 40MM HEX BLT,GR 10.9, ZP
4	4	201-0428	10MM-1.5 X 50MM HEX BOLT GRD.8.8 ZP
5	4	201-0444	3/8-16 X 2 HEX BOLT GRADE 5 ZP.
6	4	201-0440	3/8-16 X 1 1/2 HEX BOLT, GRD.5, ZP
7	12	203-0104	10MM LOCK WASHER, ZP.
8	8	203-0010	3/8 LOCK WASHER, ZP
9	4	203-0003	3/8 FLAT WASHER, ZP
10	8	61-5208	WLD, NUT PLT, 1/4X1X1, 3/8"/14"WIRE
11	2	201-0553	1/4-20 X 1/2 HX.WSHD.TYPE F TCS, ZP
12	2	201-0192	10-32 X 1/2 SLOT, RD. HD. SCREW
13	2	203-0054	#10 LOCK WASHER
14	2	202-0047	#10-32 HEX NUT
15	2	101-5822	ADAPTER, 4 WAY CONNECTOR
16	2	62-3468	ATT TAB ASSY, REM, SF/SB, 1 HOLE
	2	226-0046	BASEPLATE SAFETY CABLE, 36" CL III (Not Shown)
	2	229-0359	QUICKLINK, 3/8, ZP (Not Shown)
	2	290-0437	RECEIVER, CAP PLUG (BLK) (Not Shown)

Tools Required

10mm Socket	Drill
13mm Socket	Flat Screw Driver
17mm Socket	Phillips Screwdriver
9/16" Socket/Wrench	Utility Knife
5/8" Socket	Pliers
Large Vise Grips	Tape Measure
Reciprocating Saw	1 1/4" Hole Saw
Loctite® RED	

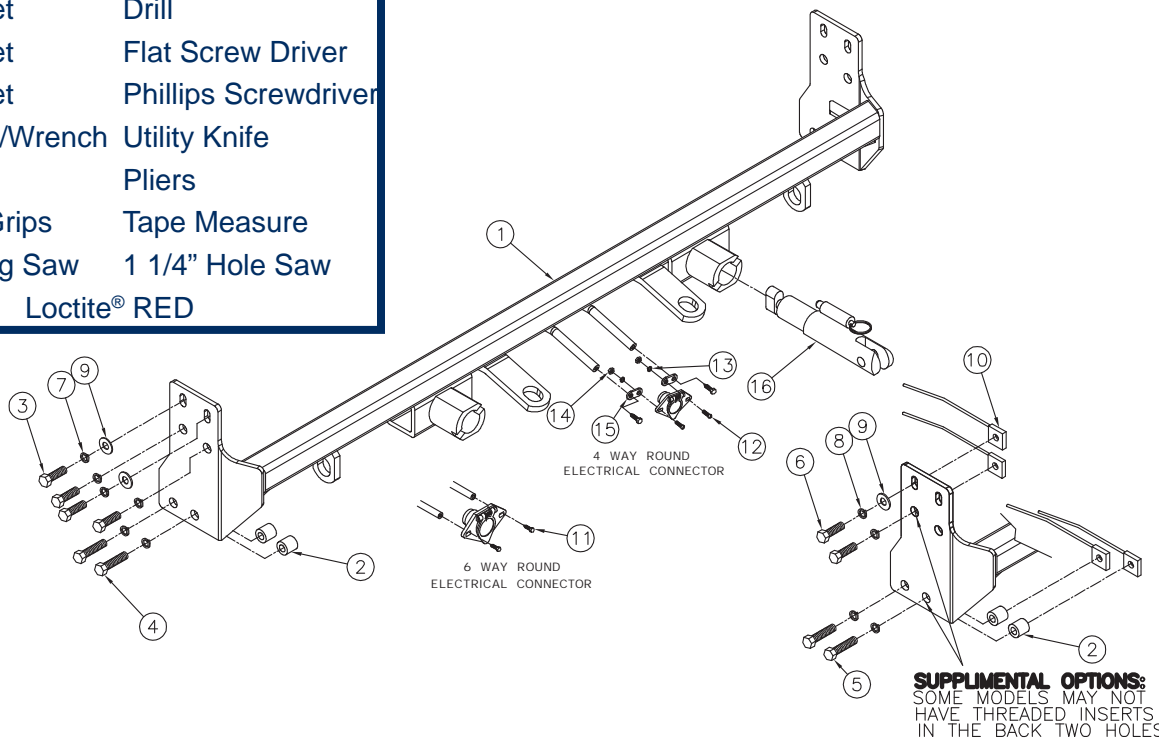

Important:

Use only genuine factory replacement parts on your baseplate. Do **NOT** substitute homemade or non-typical parts. If a bolt is lost or in need of replacement, for your safety and the preservation of your baseplate, be sure to use a replacement bolt of the same grade (In most cases it will be Grade 5, please reference the parts list above). Replacement parts may be ordered through your nearest Blue Ox® Dealer or Distributor. Failing to follow and/or altering these installation instructions in either installation or required equipment will void the manufacturer's warranty. Towing behind a non-motorized vehicle will void the warranty.

BX2609
2005-08 Ford Escape, 2005-08 Ford Escape
Hybrid, 2008 Mercury Mariner
Installation Instructions

Vehicle Weight:

Motorhome mount tow bars are recommended for use with this baseplate. Due to the design of the removable tabs, the RangeFinderII, Adventurer, and Ambassador tow bars can not be used. The Acclaim tow bar may be used, but will not fold and store on the front of the vehicle. Adapters, except the BX8833 and BX88151, can not be used with this baseplate.

Installation Notes: The fascia and air dam are removed for installation. Some trimming is required.

The dimensional variations between otherwise identical vehicles can be considerable. While the baseplate was designed for easy installation, it may be necessary to tailor the baseplate slightly to compensate for auto manufacturer's tolerances. These minor adjustments may include filing a hole slightly, bending electrical rods or bending end plates.

The BX8869 Bulb and Socket Wiring Kit is recommended for this vehicle.



Installation Instructions:



1. Using a 10MM socket, remove a metric bolt from the top edge of the grill, located just inside head light assembly. Do this to both sides of the vehicle. Set bolts aside to be reinstalled later.



2. Using a phillips screwdriver, remove a pushpin located just below the license plate. Do this to both sides of the license plate. Set pushpins aside to be reinstalled later.

Handling of some cosmetic parts when installing this product may require the use of protective covers, rags, specialty tools, etc. to prevent damage.

BX2609
2005-08 Ford Escape, 2005-08 Ford Escape
Hybrid, 2008 Mercury Mariner
Installation Instructions



3. Using a phillips screwdriver, remove three pushpins, located just forward of the front tire. Do this to both sides of the vehicle. Set pushpins aside to be reinstalled later.



4. Using a 10MM socket, remove two metric bolts just forward of the front tire, on the bottom edge of the fascia. Do this to both sides of the vehicle. Set bolts aside to be reinstalled later.



5. Using a phillips screwdriver, remove a pushpin from the driver's side, located in the upper corner of the fascia behind the wheel well. Set pushpins aside to be reinstalled. Some models may not have this push pin, if not pull fascia corner to the side and forward. Do this to both sides.

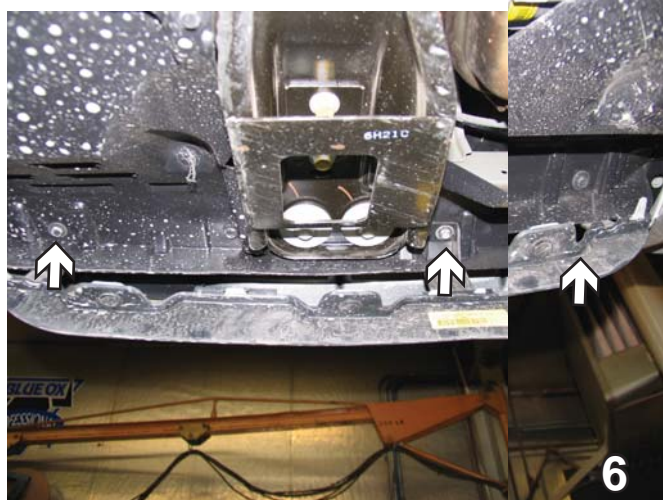

6. Using a 10MM socket, remove three metric bolts from the bottom edge of the fascia. Pull fascia forward and set it aside carefully along with the bolts to be reinstalled later. Some models may need to disconnect electrical plugs from the fog lights.

7. Remove two pushpins from the air dam and then remove two brass clips from the lower edge of the radiator. Do this to both sides of the vehicle. Set air dam, pushpins and clips aside to be reinstalled later.



BX2609
2005-08 Ford Escape, 2005-08 Ford Escape
Hybrid, 2008 Mercury Mariner
Installation Instructions

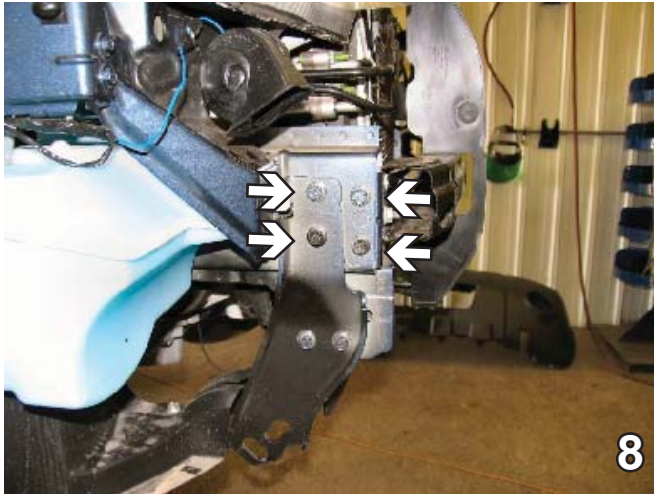

8. Using a 13MM socket, remove four existing bolts from the tie down bracket. Do this to both sides of the vehicle. The tie down brackets will not be reinstalled.

*Some models may not have tie down brackets and will need to follow Supplemental Options on page 2 drawing. These bolt locations do not have threaded inserts in the frame. Drill 1 1/4" hole into the front side of lower frame extension to insert nut plates into frame that align with existing holes. Do this to both sides. See white arrow of photo on Step 15.



10. Using a pliers, bend over to the inside of the frame. Do this to both sides of the vehicle.

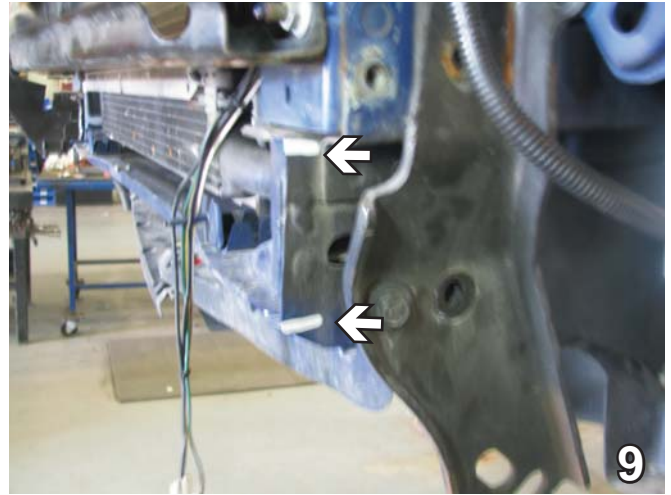

9. Using a reciprocating saw make two slits in the frame. Do this to both sides of the vehicle.

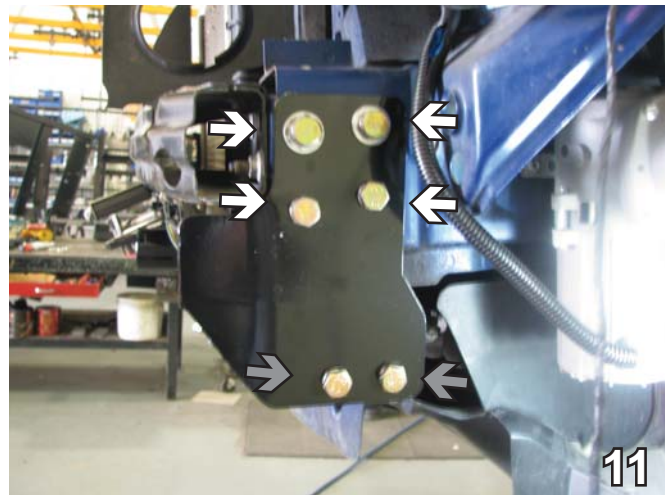

11. Align baseplate with the existing holes of the tie down bracket and insert a 10MMx40MM hex bolt, with a 10MM lock washer and 3/8" flat washer into the top two holes. The middle two holes have a 10MMx40MM hex bolt, with a 10MM lock washer. The bottom two holes have a 10MMx50MM hex bolt, with a 10MM lock washer. Then tighten down using the existing nuts in the frame, with a 13MM socket. Use Loctite Red on all the bolts.*

BE SURE TO USE LOCTITE® RED ON ALL BOLTS BEFORE TIGHTENING. TIGHTEN ALL BOLTS ACCORDING TO THE TORQUE CHART ON THE FRONT PAGE OF THESE INSTRUCTIONS OR ON PAGE 3 OF THE BASEPLATE TOWING GENERAL INSTRUCTIONS.

BX2609
2005-08 Ford Escape, 2005-08 Ford Escape
Hybrid, 2008 Mercury Mariner
Installation Instructions



12. Align the air dam as close to the original position as possible, just forward of the baseplate. Mark and trim out area for the air dam and reinstall it to the original position.
Note: Baseplate is painted white to increase visibility for instructions only.

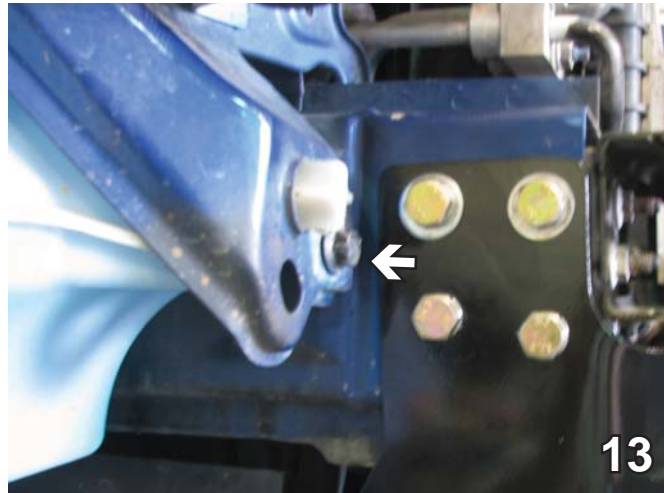

13. Reinstall the existing metric bolt into the fender support.



14. Attach the permanent baseplate safety cables to the provided convenience link on the baseplate (see grey arrow). The photo above shows the recommended installation of the cables to frame of vehicle (see white arrow). Additional options may interfere with suggested mounting; in this case secure the cables to a solid piece of the frame as described in the instructions included with the permanent baseplate safety cables. Be sure the safety cables do not rub against any hoses or moving parts. Do this to both sides of the vehicle.



15. On the passenger side, permanent baseplate safety cables are wrapped around twice (gray arrow).

16. Reinstall fascia, bolts and pushpins. The installation of the baseplate is complete.

Install the tow bar and safety cables according to the instructions provided in their packages. When demonstrating this to the customer, be sure to include all the contents and packages.

Do **NOT** substitute other devices if the tow bar pins and clips are misplaced.

BX2609
2005-08 Ford Escape, 2005-08 Ford Escape
Hybrid, 2008 Mercury Mariner
Installation Instructions

Be sure that **ALL** electrical connections are plugged in properly and functioning **BEFORE** installing the fascia.

DEALER or INSTALLER:
Be certain the user receives the instruction sheets for their products.

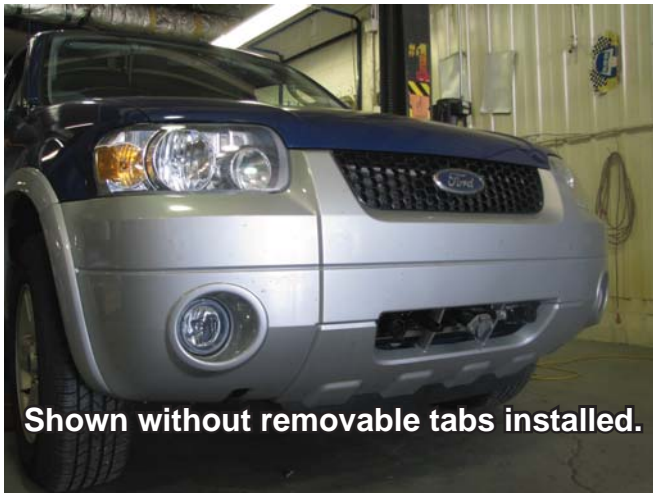

If the baseplate is in an accident, it must be replaced. **DO NOT** use it again! An accident can cause unseen damage and using it again could result in more damage or serious injury. **DO NOT** use the baseplate if it is damaged or missing parts.

CUSTOMER SERVICE COMMITMENT

Blue Ox is committed to providing you with exceptional customer care throughout your lifetime with our products. Our team is here to assist you with any questions you may have regarding the performance of your product. Simply call 1-(402) 385-3051 and you can speak with our customer care team.

Additionally, please visit our website to see which rallies our Destination America team will be attending. For a nominal fee, our service technician will service your towing system to ensure it's in proper working condition. Also as a commitment to our customers, should you visit our factory you can stay at our full service Blue Ox campground at no charge along with enjoying a factory tour.

Again thank you for being our customer and for the confidence you have shown in the performance of our products. It is because of customers like you we enjoy the success we have today.



© 2009, 10 Blue Ox
One Mill Road, Industrial Park
Pender, Nebraska 68047
Phone: (402) 385-3051 • Fax: (402) 385-3360
www.blueox.com