



BX2636

2013 Ford Flex SE Installation Instructions

Serial Number

Attachment Tab Height: 15-1/2"

Attachment Tab Width: 20"

Please read BOTH these Installation Instructions and the General Instructions prior to installing or operating this equipment.

- Blue Ox® towing products and accessories are intended to be installed by Blue Ox® Dealers who are familiar with our products and have the equipment and knowledge necessary to do "fit work". If needed, Blue Ox® Dealers can be found at www.blueox.com or by contacting our Customer Care Department at (402) 385-3051.
- Many Blue Ox® baseplates are designed to use existing holes and hardware to mount the baseplate to the towed vehicle. Even though bolts are there, do not assume they are adequate for baseplate mounting. Always use the hardware supplied in the hardware kit and existing hardware as specified in the installation instructions.

Bolt Torque Specifications
Torque in Foot-Pounds for Inch Bolts

Bolt Size	Grade 5	Grade 8
1/4"	10	14
5/16"	19	29
3/8"	33	47
7/16"	54	78
1/2"	78	119
5/8"	154	230
3/4"	257	380

Bolt Torque Specifications
Torque in Foot-Pounds for Metric Bolts

Bolt Size	Grade 8.8	Grade 10.9
6MM	6	8
8MM	16	22
10MM	31	40
12MM	54	70
14MM	89	117
16MM	161	230
18MM	222	318



If the front of your vehicle looks different than this, please contact us at (402)385-3051.

Reference your vehicle owner's manual for manufacturer's towing specifications.

! WARNING

Failure to read and follow these instructions could result in separation of the towed vehicle from the tow bar, causing property damage, loss of towed vehicle, personal injury or death.

BX2636
2013 Ford Flex SE
Installation Instructions

Instruction Notes: The fascia, horn, center panel, grill and windshield washer fluid reservoir are removed for the baseplate installation. Installation may require some drilling.

Place all components that are removed on a flat, sturdy surface. These items will be reinstalled unless otherwise noted after the baseplate is installed.

The dimensional variations between otherwise identical vehicles can be considerable. While the baseplate was designed for easy installation, it may be necessary to tailor the baseplate slightly to compensate for vehicle manufacturer's tolerances.

The BX8869 Tail Light Wiring Kit is recommended for this vehicle. An LED tail light wiring kit is also available in red (BX88267) or clear (BX88269).



Drill a hole according to the tail
light wiring kit.

NOTICE

- Handling of some cosmetic parts when installing this product may require the use of protective covers, rags, specialty tools, etc. to prevent damage.
- When using power drills be aware of the dangers of torque and drill bit length.
- When using a reciprocating saw be aware of objects behind the cutting surface.
- Use a good quality paint to spray cut edges of frame to prevent rusting.
- Be sure that **ALL** electrical connections are plugged in and accessories are functioning properly before reinstalling the fascia.
- The baseplate is computer tested to your vehicle's GVWR, exceeding this weight will void the manufacturer's warranty.
- Be sure to use Loctite® Red on all bolts before tightening. Tighten all bolts according to the torque chart provided.
- Dealer or installer be certain the user receives these instruction sheet.
- If the baseplate is in an accident, it must be replaced. **DO NOT** use it again! An accident can cause unseen damage and using it again could result in more damage or serious injury. **DO NOT** use the baseplate if it is damaged or missing parts.

BX2636
2013 Ford Flex SE
Installation Instructions

Tools Required

- 5.5MM Socket
- 8MM Socket
- 10MM Socket
- 11MM Socket
- 9/16" Socket
- Large Vise Grip
- Flat Screwdriver
- Phillips Screwdriver
- Utility Knife
- Torque Wrench
- Tape Measure
- Loctite® Red
- Drill
- 13/32" Drill Bit
- Flat Chisel
- Hammer

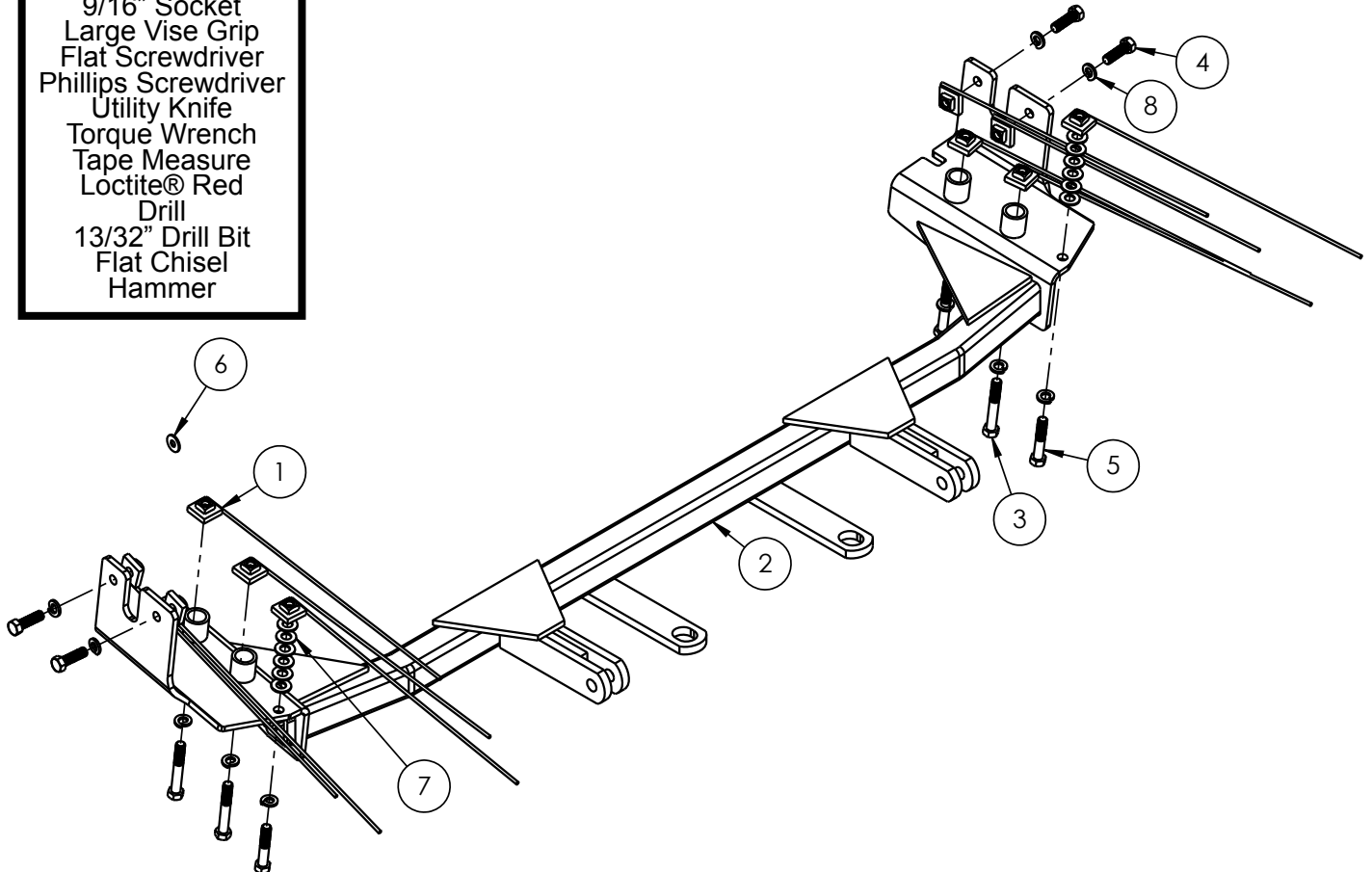

Item No.	Part No.	Description	Qty.
1.....	61-5208.....	3/8"-16 Nut Plate with 14" Wire	10
2.....	61-7069.....	BX2636 Baseplate.....	1
3.....	201-0336.....	3/8"-16 x 2-1/2" Hex Head Bolt, Grade 5, ZP	4
4.....	201-0368.....	3/8"-16 x 1-1/4" Hex Head Bolt, Grade 5, ZP	4
5.....	201-0444.....	3/8"-16 x 2" Hex Head Bolt, Grade 5, ZP	2
6.....	203-0001.....	1/4" Flat Washer, ZP.....	7
7.....	203-0003.....	3/8" Flat Washer, ZP.....	12
8.....	203-0010.....	3/8" Lock Washer, ZP.....	10
9.....	226-0046(not shown).....	Class III Safety Cables.....	2
10.....	229-0359(not shown).....	3/8" Quicklink, ZP.....	2

Important:

Use only genuine factory replacement parts on your baseplate. Do **NOT** substitute homemade or non-typical parts. If a bolt is lost or in need of replacement, for your safety and the preservation of your baseplate, be sure to use a replacement bolt of the same grade (In most cases it will be Grade 5, please reference the parts list above). Replacement parts may be ordered through your nearest Blue Ox® Dealer or Distributor. Failing to follow and/or altering these installation instructions in either installation or required equipment will void the manufacturer's warranty. Towing behind a non-motorized vehicle will void the warranty.

BX2636
2013 Ford Flex SE
Installation Instructions

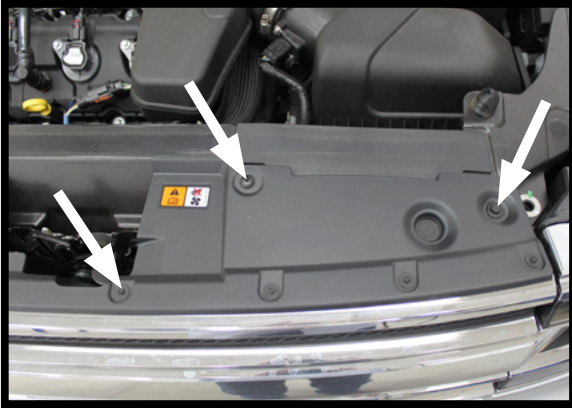

1. Using a 10MM socket, remove the two (2) bolts and push pins that are located in the front area, one (1) per side. There are eight (8) bolts along the front that also need to be removed using a 5.5MM socket.



2. Using a 5.5MM socket, remove the three (3) bolts in the wheel well area. Do this on both sides.

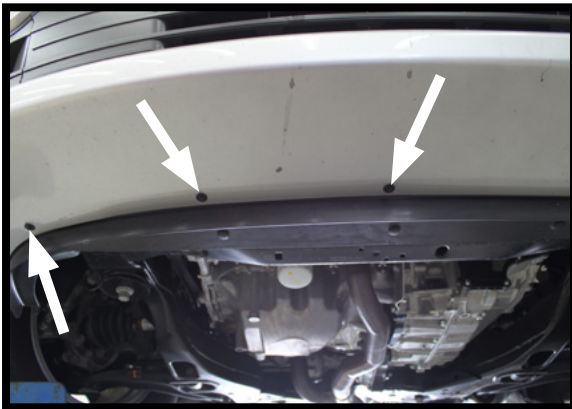

3. On the underside of the vehicle use a 5.5MM socket to remove seven (7) bolts.

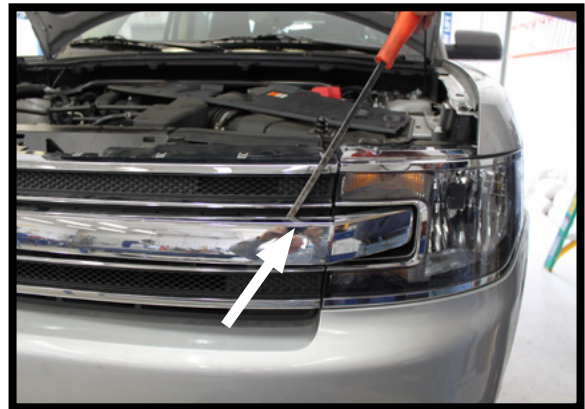

4. Use a flat screwdriver to gently pry the center panel out.



5. Once the center panel has been removed, use a 10MM socket to remove the bolt. There is one (1) on each side of the vehicle.



6. Next, remove the grill by gently pulling it forward.

BX2636
2013 Ford Flex SE
Installation Instructions

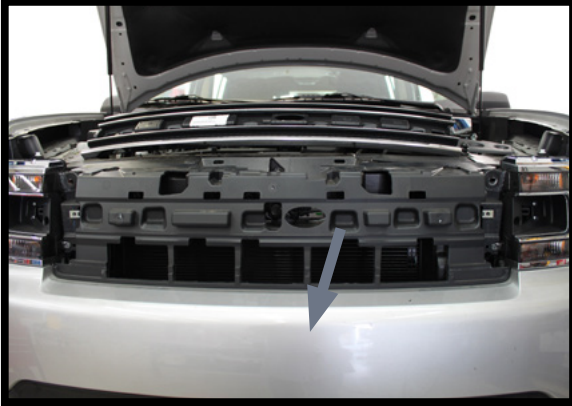

7. The front fascia can now be removed by pulling firmly outward.



8. On the driver's side, remove the horn using an 8MM socket.

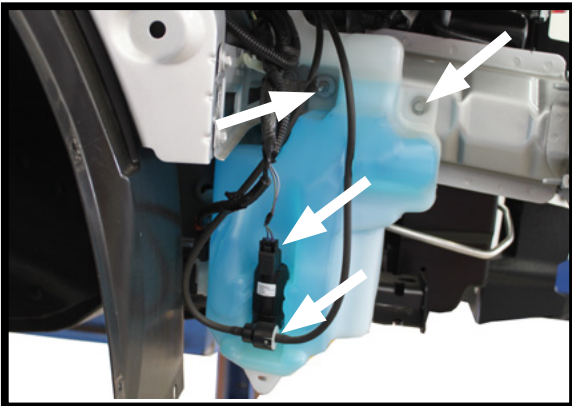

9. The windshield wiper fluid reservoir needs to be removed on the passenger side. Unplug all electrical components and remove the bolt on the top, right side using a 8MM socket. Using a 11MM socket, remove the other two (2) bolts.

Be sure to plug the lines to avoid fluid leakage.

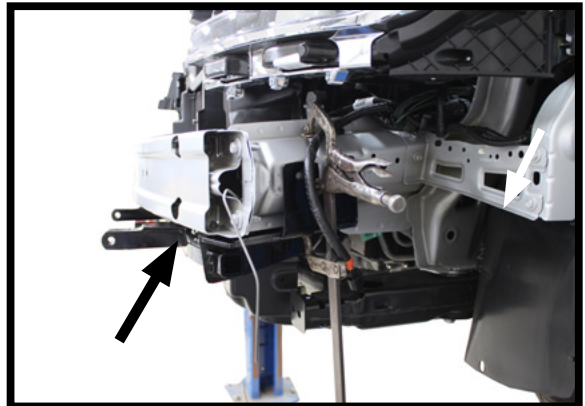

10. Clamp the baseplate securely into place and verify it is aligned evenly.

BX2636
2013 Ford Flex SE
Installation Instructions

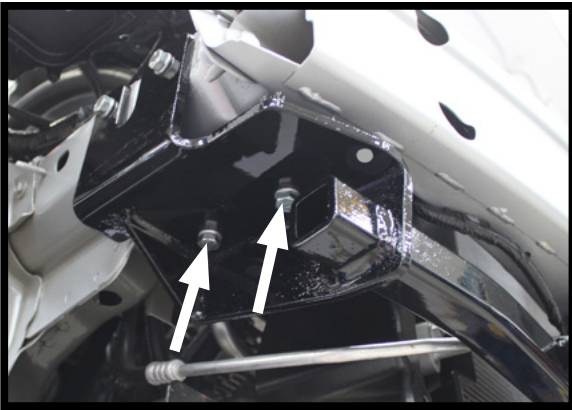

11. Using a 13/32" drill bit and the baseplate as a template, drill the bottom, back two (2) holes.

Insert the 3/8"-16 x 2-1/2" hex head bolts, 3/8" lock washers and fasten securely with the 3/8"-16 nut plates.

Do this on both sides of the vehicle.



12. Using a 13/32" drill bit, drill the top two (2) holes.

Insert the 3/8"-16 x 1-1/4" hex head bolts, 3/8" lock washers and fasten securely with the 3/8"-16 nut plates.

Do this on both sides of the vehicle.

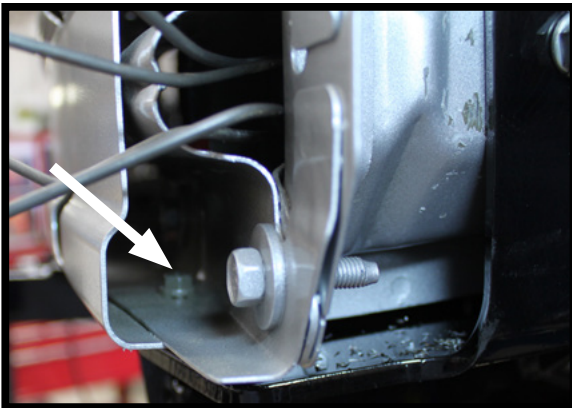

13. On the driver's side only, use a flat chisel to remove the nut that is located on the outer edge inside the vehicle frame rail.

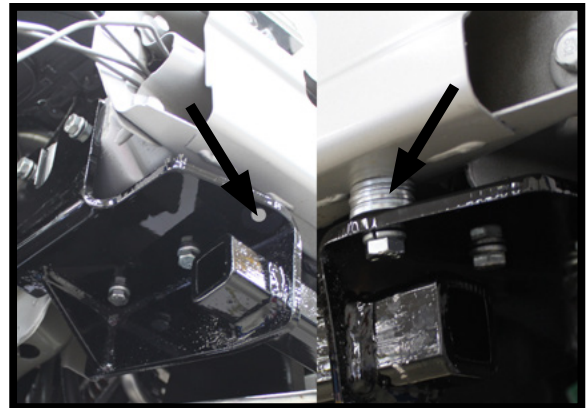

14. Continue using the 13/32" drill bit and drill the bottom, front hole.

Insert the 3/8"-16 x 2" hex head bolts, 3/8" lock washers. Place six (6) 3/8" flat washer and fasten securely with the 3/8"-16 nut plates.

Do this on both sides of the vehicle.

BX2636
2013 Ford Flex SE
Installation Instructions

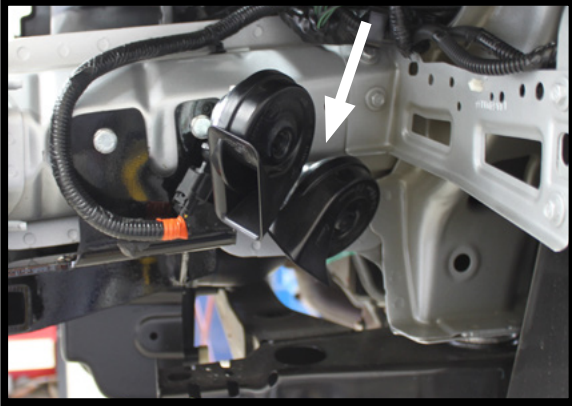

15. Reinstall the horn to the original location. It may require bending slightly.

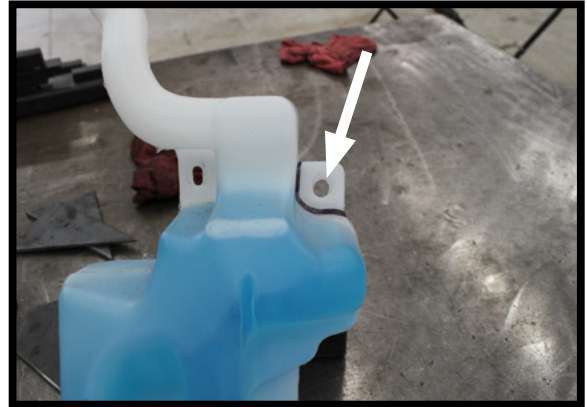

16. Prior to reinstalling the windshield wiper reservoir, notch as shown above.

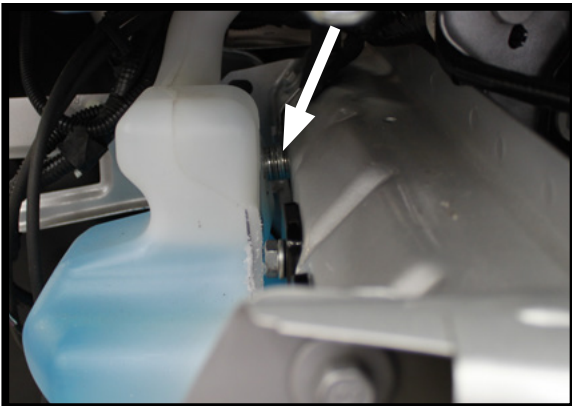

17. Place seven (7) 1/4" flat washers behind the reservoir on the inner most side prior to tightening the existing bolts.

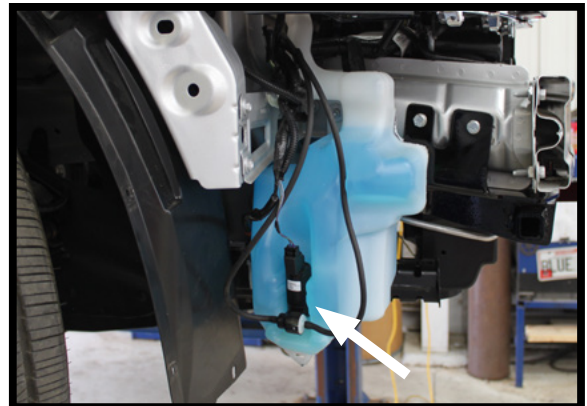

18. Reattach all electrical wiring and fluid lines.

19. Attach the permanent baseplate safety cables to the provided convenience link on the baseplate. Additional options may interfere with suggested mounting; in this case, secure the cables to a solid piece of the frame as described in the instructions included with the permanent baseplate safety cables. Be sure the safety cables do not rub against any hoses or moving parts. Do this on both sides of the vehicle.

BX2636
2013 Ford Flex SE
Installation Instructions



20. Hold the fascia as close to its original position, mark and trim the fascia around the convenience links and attachment tabs. Reinstall the fascia, grill and center panel.

CUSTOMER SERVICE COMMITMENT

Blue Ox® is committed to providing you with exceptional customer care throughout your lifetime with our products. Our team is here to assist you with any questions you may have regarding the performance of your product. Simply call (402) 385-3051 and you can speak with our customer care team.

Additionally, please visit our website to see which rallies our Destination America team will be attending. For a nominal fee, our service technician will service your towing system to ensure it's in proper working condition. Also, as a commitment to our customers, should you visit our factory, you can stay at our full service Blue Ox® campground at no charge along with enjoying a factory tour.

Again, thank you for being our customer and for the confidence you have shown in the performance of our products. It is because of customers like you we enjoy the success we have today.

© 2013 Blue Ox
One Mill Road, Industrial Park
Pender, Nebraska 68047
Phone: (402) 385-3051
Fax: (402) 385-3360
www.blueox.com