



## BX2650

# 2014-19 Ford Fiesta (Includes EcoBoost) Installation Instructions

Please read **BOTH** these Installation Instructions and the General Instructions prior to installing or operating this equipment.

1. Blue Ox® towing products and accessories are intended to be installed by Blue Ox® Dealers who are familiar with our products and have the equipment and knowledge necessary to do “fit work”. If needed, Blue Ox® Dealers can be found at [www.blueox.com](http://www.blueox.com) or by contacting our Technical Service Department at (402) 385-3051.
2. Many Blue Ox® baseplates are designed to use existing holes and hardware to mount the baseplate to the towed vehicle. Even though bolts are there, do not assume they are adequate for baseplate mounting. Always use the hardware supplied in the hardware kit and existing hardware as specified in the installation instructions.



If the front of your vehicle looks different than this, please contact us at (402)385-3051.

**Reference your vehicle owner’s manual for manufacturer’s towing specifications.**

**Serial Number**

**Attachment Tab Height: 22”**

**Attachment Tab Width: 24”**

### Bolt Torque Specifications

Torque in Foot-Pounds for Inch Bolts

Bolt Size	Grade 5	Grade 8
1/4”	10	14
5/16”	19	29
3/8”	33	47
7/16”	54	78
1/2”	78	119
5/8”	154	230
3/4”	257	380

### Bolt Torque Specifications

Torque in Foot-Pounds for Metric Bolts

Bolt Size	Grade 8.8	Grade 10.9
6MM	6	8
8MM	16	22
10MM	31	40
12MM	54	70
14MM	89	117
16MM	161	230
18MM	222	318

## **WARNING**

Failure to read and follow these instructions could result in separation of the towed vehicle from the tow bar, causing property damage, loss of towed vehicle, personal injury or death.

BX2650  
2014-19 Ford Fiesta (Includes EcoBoost)  
Installation Instructions

**Instruction Notes:** The headlights, fascia and windshield washer fluid reservoir are removed and reinstalled for the baseplate installation. Some drilling and trimming is required.

Place all components that are removed on a flat, sturdy surface. All items will be reinstalled unless otherwise noted after the baseplate is installed.

The dimensional variations between otherwise identical vehicles can be considerable. While the baseplate was designed for easy installation, it may be necessary to tailor the baseplate slightly to compensate for vehicle manufacturer's tolerances.

The BX8869 Tail Light Wiring Kit is recommended for this vehicle.

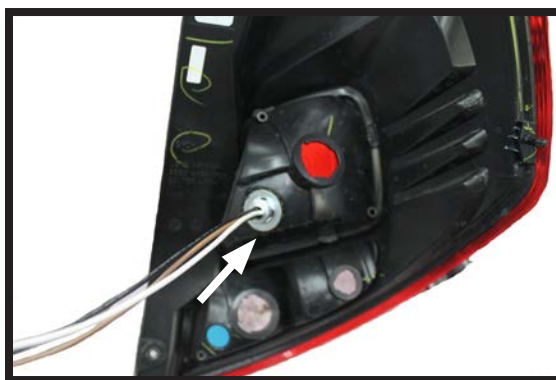

Drill a hole according to the tail  
light wiring kit instructions.

### **NOTICE**

- Handling of some cosmetic parts when installing this product may require the use of protective covers, rags, specialty tools, etc. to prevent damage.
- When using power drills be aware of the dangers of torque and drill bit length.
- When using a reciprocating saw be aware of objects behind the cutting surface.
- Use a good quality paint to spray cut edges of frame to prevent rusting.
- Be sure that **ALL** electrical connections are plugged in and accessories are functioning properly before reinstalling the fascia.
- The baseplate is computer tested to your vehicle's GVWR, exceeding this weight will void the manufacturer's warranty.
- Be sure to use a sufficient amount of Loctite® Red on all bolt threads before tightening. Tighten all bolts according to the torque chart provided.
- Dealer or installer be certain the user receives these instruction sheets.
- If the baseplate is in an accident, it must be replaced. **DO NOT** use it again! An accident can cause unseen damage and using it again could result in more damage or serious injury. **DO NOT** use the baseplate if it is damaged or missing parts.

# BX2650

## 2014-19 Ford Fiesta (Includes EcoBoost)

### Installation Instructions

#### Tools Required

Large Vise Grip  
 Flat Screwdriver  
 Utility Knife  
 Phillips Screwdriver  
 Torque Wrench  
 Drill  
 Reciprocating Saw  
 Tape Measure  
 Loctite® RED  
 1-1/4" Hole Saw  
 13/32" Drill Bit  
 T25 Torx  
 T30 Torx  
 7MM Socket  
 8MM Socket  
 9/16" Socket  
 9/16" Wrench

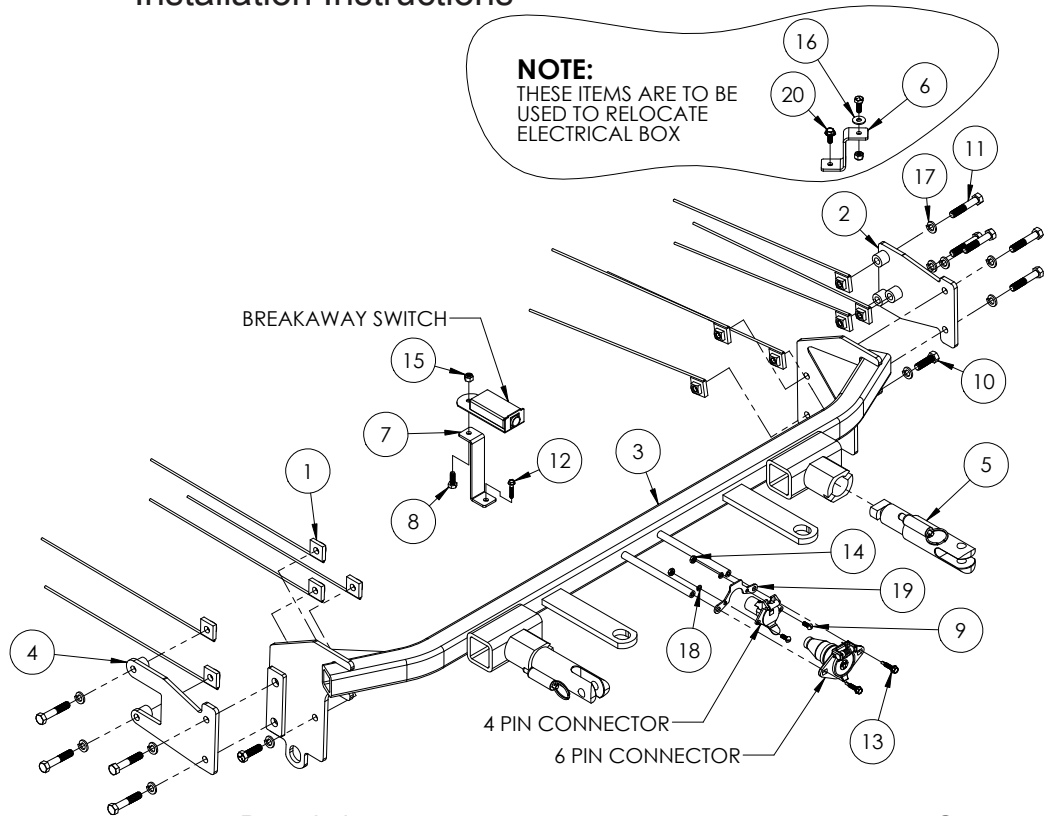

Item No.	Part No.	Description	Qty.
1	61-5208	3/8"-16 Nut Plate w/ Wire	11
2	61-6787	Driver Side Support Bracket	1
3	61-7304	BX2650 Baseplate	1
4	61-7305	Passenger Side Support Bracket	1
5	62-3468	Attachment Tab Assembly with Hole	2
6	102-7056	Fuse Box Bracket	1
7	102-7116	Breakaway Bracket	1
8	201-0050	1/4"-20 x 3/4" Hex Head Bolt, Grade 5, ZP	2
9	201-0192	#10-32 1/2" Round Slotted Head Screw	2
10	201-0368	3/8"-16 x 1-1/4" Hex Head Bolt, Grade 5, ZP	2
11	201-0444	3/8"-16 x 2" Hex Head Bolt, Grade 5, ZP	9
12	201-0654	#10-16 x 1" Self Drilling Screw, ZP	1
13	201-0979	#12-14 x 1" Self Drilling Screw, ZP	2
14	202-0047	#10-32 Hex Nut	2
15	202-0102	1/4"-20 Hex Nylon Nut, ZP	2
16	203-0001	1/4" Flat Washer	1
17	203-0010	3/8" Lock Washer, ZP	11
18	203-0054	#10 Lock Washer, ZP	2
19	299-0685	4-Way Bracket	1
20	Existing	6MM Flange Bolt	1
21	226-0046(not shown)	Class III Safety Cables	2
22	229-0359(not shown)	3/8" Quicklink, ZP	2
23	290-0437(not shown)	Black Cap Plug Receiver	2

#### Important:

Use only genuine factory replacement parts on your baseplate. Do **NOT** substitute homemade or non-typical parts. If a bolt is lost or in need of replacement, for your safety and the preservation of your baseplate, be sure to use a replacement bolt of the same grade (In most cases it will be Grade 5, please reference the parts list above). Replacement parts may be ordered through your nearest Blue Ox® Dealer or Distributor. Failing to follow and/or altering these installation instructions in either installation or required equipment will void the manufacturer's warranty. Towing behind a non-motorized vehicle will void the warranty.

BX2650  
2014-19 Ford Fiesta (Includes EcoBoost)  
Installation Instructions



1. Remove the four (4) Phillips head push pins from the top edge of the fascia. There are two (2) on each side.



2. Using a T25 Torx, remove the two (2) screws from the wheel well. Do this on both sides of the vehicle.

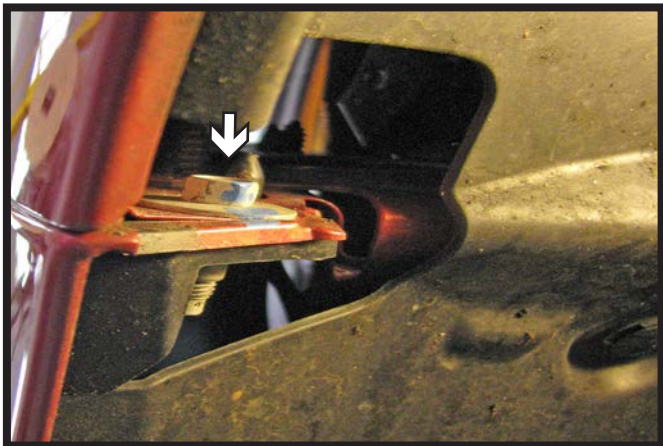

3. Using a 8MM socket, remove the screw from the upper edge of the wheel well. Do this on both sides of the vehicle.



4. Using a 7MM socket, remove the five (5) screws from the underside of the fascia. There are two (2) in each corner and one (1) in the middle.

BX2650  
2014-19 Ford Fiesta (Includes EcoBoost)  
Installation Instructions



5. Using a T30 Torx, remove the two (2) screws from the headlight. Disconnect the electrical line and set the head light aside. Do this on both sides of the vehicle.



6. Using a 8MM socket, remove the two (2) screws from the edge of the fascia underneath the headlight. Do this on both sides vehicle.

Remove the fascia from the vehicle, disconnecting all electrical connections.



7. Disconnect the wire loom clips from the frame (gray). Using a 10MM socket, remove the two (2) screws from the washer fluid reservoir (white). Disconnect all lines and plug fluid lines. Set the reservoir aside.

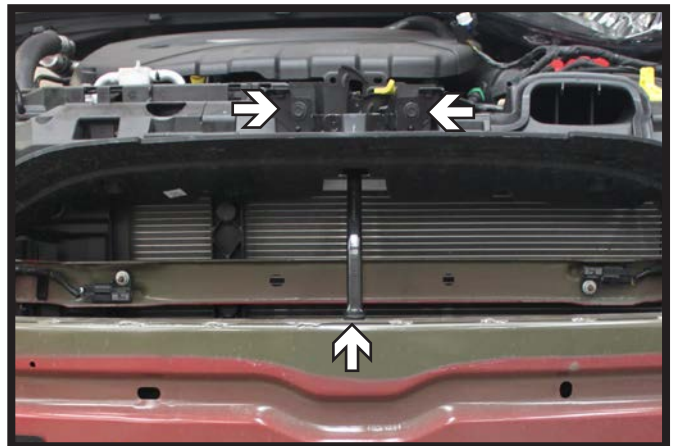

8. Using a 10MM socket, remove the three (3) screws from the latch support brace and pull the brace upwards away from the bumper for baseplate installation.

BX2650  
2014-19 Ford Fiesta (Includes EcoBoost)  
Installation Instructions

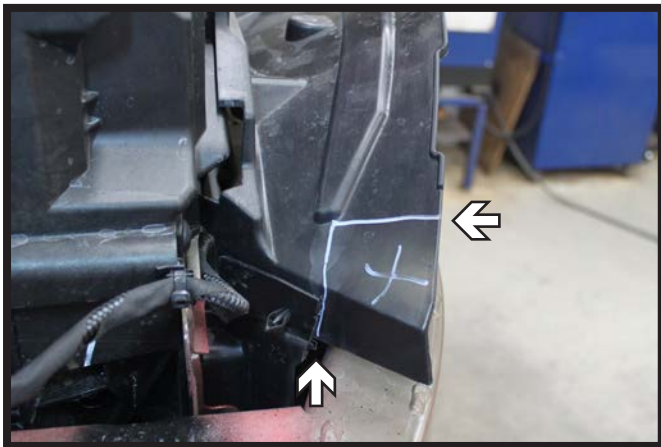

9. **ST/SE Models:** Trim the upper shrouding as shown for baseplate clearance. Do this on both sides of the vehicle.

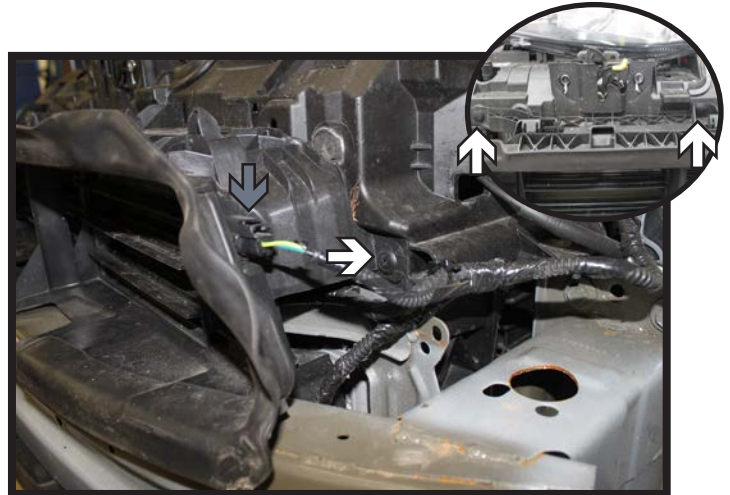

10. **SFE Models:** Remove the four (4) push pins from the shutter shrouding. There is one (1) on each side (white) and two (2) in the middle (inset).

On the driver side only, remove the temperature sensor and set aside (gray).



11. **SFE Models:** On top of the shutter shrouding, unsnap the two (2) clips and remove the front section of the shrouding. Then remove the back half from from the vehicle. This shrouding will not be reinstalled after baseplate installation.

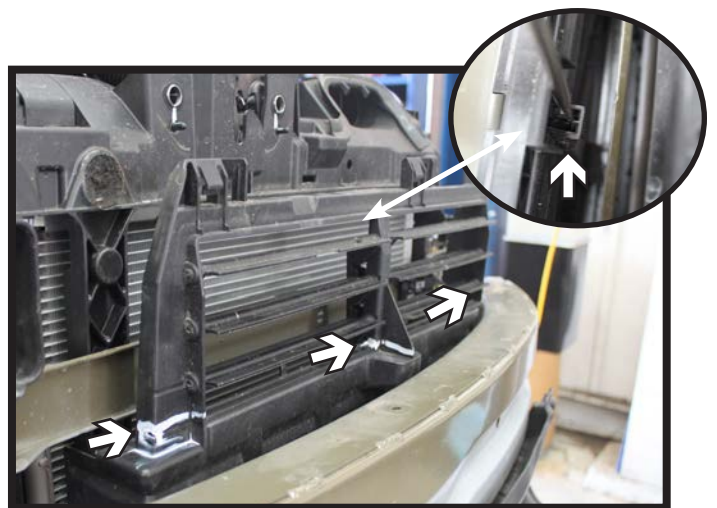

12. **SFE Models:** Using a flat screwdriver, disconnect the back rod from the shutter system (inset).

Trim the upper section of the shutter system off flush with base as shown for baseplate clearance.

BX2650  
2014-19 Ford Fiesta (Includes EcoBoost)  
Installation Instructions

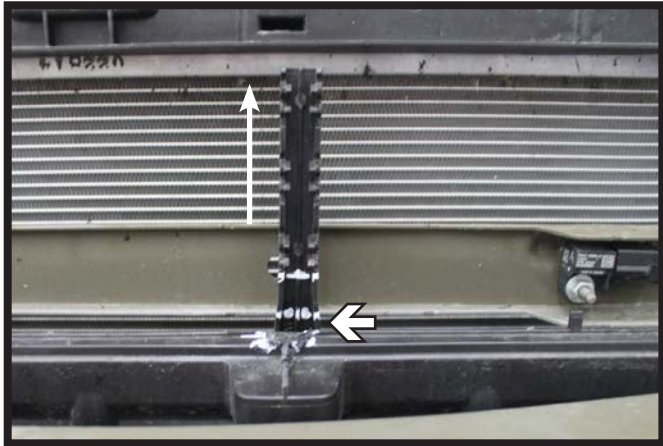

13. **SFE Models:** Pull up on the shutter rod. Trim off the rod flush with the base for baseplate clearance.

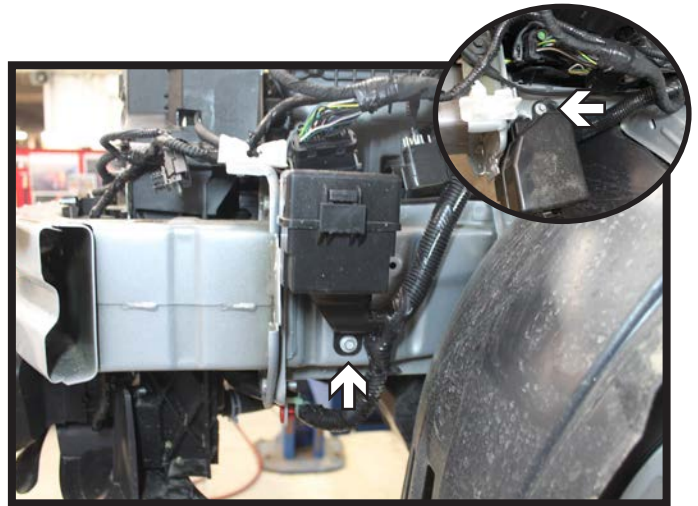

14. **SFE Models:** On the driver side, using a 8MM socket, remove the two (2) screws from the fuse box. Set the box aside.

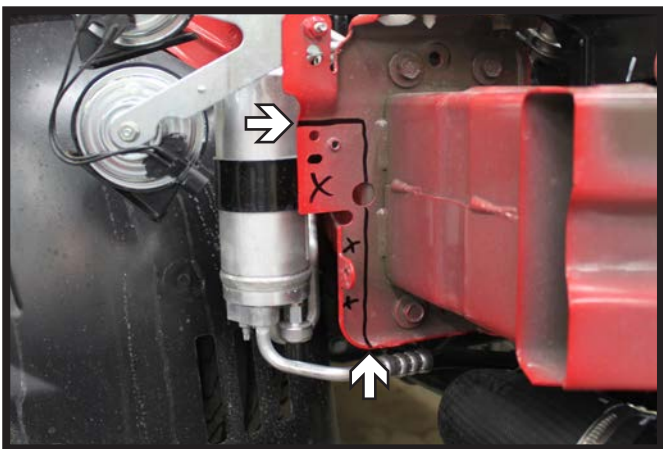

15. Trim the face of the frame extension just below the rib (top arrow) back to the face of the frame (bottom arrow). Do this on both sides of the vehicle.

 Be aware of lines behind face when cutting!



16. Using a 1-1/4" hole saw, drill an access hole on top of the bumper as shown. Do this on both sides of the vehicle.

BX2650  
2014-19 Ford Fiesta (Includes EcoBoost)  
Installation Instructions

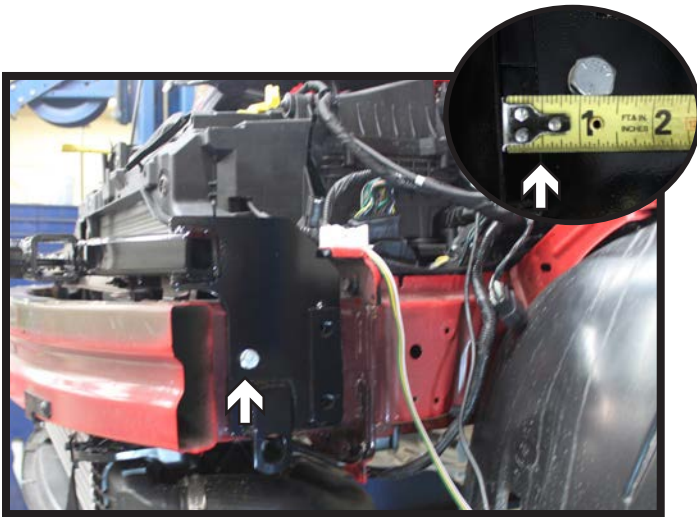

17. Position the baseplate onto the frame, flushing the bottom of the baseplate and frame. Leave a 1/2" gap from the front of the baseplate and the backside of the bumper (inset). Level and clamp into position.

Using a 13/32" drill bit, drill the front hole in the baseplate thru the frame. Install a 3/8"-16 x 1-1/4" bolt with a 3/8" lock washer into the hole and a 3/8" nut plate on the inside of the frame. Do this on both sides of the vehicle. Fully tighten both fasteners.

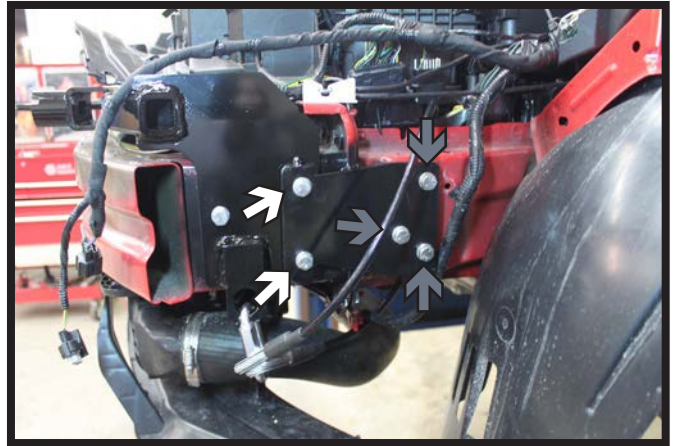

18. Using a 13/32" drill bit, drill the back baseplate holes thru the frame. Bolt the support bracket to the baseplate/frame with 3/8"-16 x 2" bolts, 3/8" lock washers and 3/8" nut plates (white).

Fully tighten the fasteners and then drill the remaining three (3) holes towards the back of the plate thru the frame. Install 3/8"-16 x 2" bolts with 3/8" lock washers into the holes with 3/8" nut plates on the inside of the frame (gray). Fully tighten all fasteners. Do this on both sides of the vehicle.



19. Attach the permanent baseplate safety cables to the provided convenience link on the baseplate. The photo above shows the recommended installation of the cables to frame of vehicle. Additional options may interfere with suggested mounting; in this case, secure the cables to a solid piece of the frame as described in the instructions included with the permanent baseplate safety cables. Be sure the safety cables do not rub against any hoses or moving parts. Do this on **BOTH** sides of the vehicle.



BX2650  
2014-19 Ford Fiesta (Includes EcoBoost)  
Installation Instructions

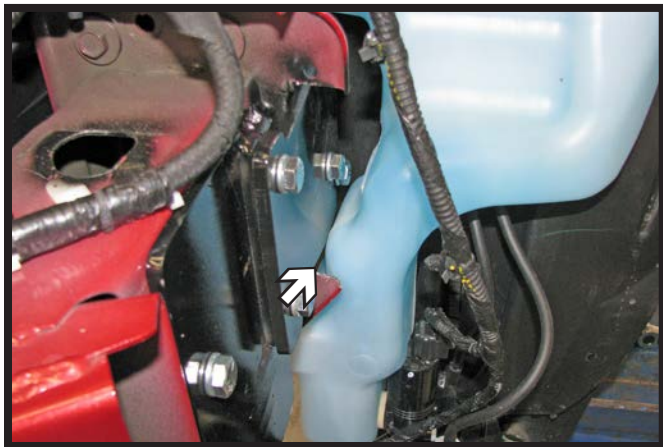

20. Reinstall the washer reservoir. Checking the clearance on the lower part of the reservoir making sure it is not rubbing on the baseplate. It should have minimum 1/16" clearance. If necessary pull the reservoir back and re-tighten the bolts. Reinstall the latch support brace.



21. **SFE Models:** On the driver side, install the supplied bracket to the frame with the existing bolt. Then the fuse box to the bracket with a 1/4"-20 x



22. **Optional Breakaway:** Install the breakaway bracket to the lower support brace using the existing bolt. Bolt the breakaway to the bracket with a 1/4"-20 x 3/4" bolt and 1/4" lock nut.

BX2650  
2014-19 Ford Fiesta (Includes EcoBoost)  
Installation Instructions



23. On the backside of the fascia, trim off the inner layer of the fascia along the outer groove as shown for baseplate clearance. Do this on both sides of the fascia.

 Be aware not to cut into the outer layer of the fascia when cutting!



24. Hold the fascia as close to its original position, mark and trim the fascia around the convenience links and attachment tabs. Reinstall the fascia and headlights.

## CUSTOMER SERVICE COMMITMENT

Blue Ox® is committed to providing you with exceptional customer care throughout your lifetime with our products. Our team is here to assist you with any questions you may have regarding the performance of your product. Simply call (402) 385-3051 and you can speak with our technical service team.

Additionally, please visit our website to see which rallies our Destination America team will be attending. For a nominal fee, our service technician will service your towing system to ensure it's in proper working condition. Also, as a commitment to our customers, should you visit our factory, you can stay at our full service Blue Ox® campground at no charge along with enjoying a factory tour.

Again, thank you for being our customer and for the confidence you have shown in the performance of our products. It is because of customers like you we enjoy the success we have today.

© 2016 Blue Ox  
One Mill Road, Industrial Park  
Pender, Nebraska 68047  
Phone: (402) 385-3051  
Fax: (402) 385-3360  
www.blueox.com

# General Information

1. Ensure that your product(s) are registered online at [www.blueox.com](http://www.blueox.com). It is crucial to register your product(s) so that you may be alerted of product offerings, updates, upgrades, maintenance and safety bulletins, and/or recalls.
2. **It is the owner's responsibility to inspect all towing equipment for cracked welds, missing or worn parts and loose bolts before each towing trip.** Be sure to use Loctite® Red on all bolts and tighten to the recommended specifications.
3. **It is the owner's responsibility to hook up all towing equipment per manufacturer's instructions/recommendations.**
4. Remove the attachment tabs when not in use (if applicable).

## Notice To Baseplate Installer

### 1. It is YOUR responsibility to watch for:

- Oil cooler and air conditioner lines
- Electrical wires and hoses
- Missing parts or attaching points on the frame

\*\* If the baseplate is improperly installed and is against a wire or hose, it could cause fluid leaks or electrical shorts some time after the actual baseplate installation.

## Permanent Baseplate Safety Cable Installation

Permanent baseplate safety cables are strongly recommended when towing a vehicle with a tow bar. The principle function of the permanent baseplate safety cables is to prevent the towed vehicle from breaking loose in the event the connection between the frame of the towed vehicle and the baseplate fails or becomes disconnected. The cables must be connected from the baseplate to the frame rail or cross member of the vehicle's frame. The illustrations below show the possible arrangements recommended by Blue Ox®. Each permanent baseplate safety cable must have an adequate weight rating for the towing system. The weight rating of the two (2) cables together will not qualify.

***Do not mount the permanent baseplate safety cables against wires, hoses or brake lines.***

These permanent baseplate safety cables should remain installed as long as the baseplate is installed on the vehicle. Permanent baseplate safety cables are to be used in conjunction with, and NOT a replacement for legally required safety cables attaching the towed vehicle to the towing vehicle.

### OPTION #1

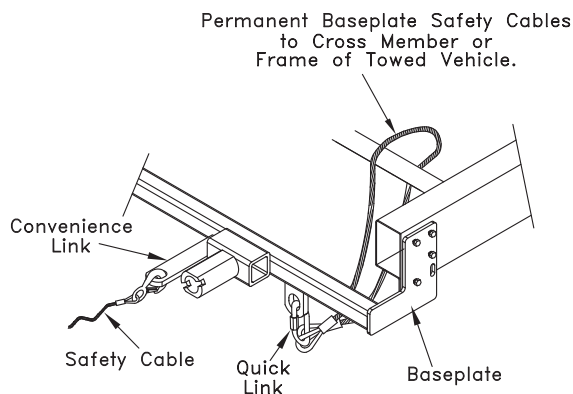

### OPTION #2

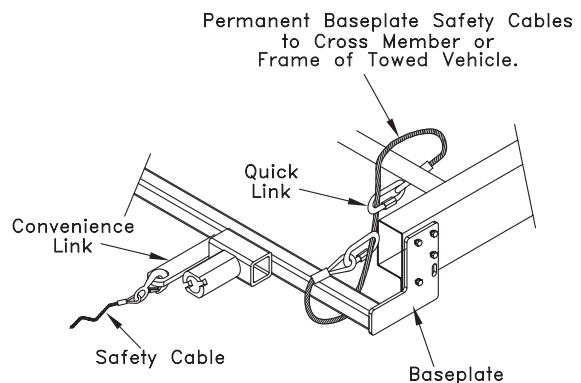

# BLUE OX ORIGINAL PURCHASERS THREE YEAR LIMITED WARRANTY

Automatic Equipment Manufacturing Company ("Automatic") warrants to the original (first) retail purchaser that this product, manufactured by Automatic, shall be free from defect in material and workmanship under normal use and service for a period of three years from the date of delivery.

During said three-year period, Automatic will repair or replace any parts that have been returned by the original purchaser, to the factory, transportation prepaid, and in Automatic's sole and absolute opinion found to be defective.

Limitations on Warranty Coverage:

Coverage under this warranty will be valid only if the customer warranty card is returned by the original purchaser within 30 days of purchase.

Coverage under this warranty will be effective only when a copy of the original invoice, showing date and place of purchase, accompanies any claim for warranty. This warranty is NON TRANSFERABLE.

This limited warranty will not cover, in any way or form, any alleged damages caused by incorrect or improper installation, improper use, modification or neglect of product, failure to properly service and maintain, misuse, act of God, accident or failure of the user to follow guidelines contained in the instructional material provided by Automatic.

This warranty does not cover normal wear and tear, paint or rust.

Warrantor assumes no responsibility to the owner for loss of use of product, loss of time, inconvenience or any other damage consequential or otherwise. Including, but not limited to mileage, expense of transporting of product, return shipping expense, mechanics travel time, telephone, road service, towing, and rental during repairs, travel, lodging, loss or damage to personal property or loss of earnings.

**REPAIR OR REPLACEMENT AS SET FORTH IN THIS LIMITED WARRANTY IS THE SOLE EXCLUSIVE REMEDY OF THE PURCHASER. AUTOMATIC SHALL NOT BE LIABLE FOR ANY INCIDENTAL OR CONSEQUENTIAL DAMAGES FOR BREACH OF ANY EXPRESS OR IMPLIED WARRANTY ON THIS PRODUCT. EXCEPT TO THE EXTENT PROHIBITED BY APPLICABLE LAW, ANY IMPLIED WARRANTY OF MERCHANTABILITY OR FITNESS FOR A PARTICULAR PURPOSE ON THIS PRODUCT IS LIMITED IN LENGTH TO THE DURATION OF THIS WARRANTY.**

Please visit <http://blueox.com/warranty/> to register your warranty

