



BX2673

2016-2018 Lincoln MKX (Includes ACC, EcoBoost, & Shutters)
 2015-2018 Ford Edge Sport (Includes ACC & Shutters)
 (No 2.0L EcoBoost)
 Installation Instructions

Please read BOTH these Installation Instructions and the General Information sheet prior to installing or operating this equipment.

1. Blue Ox® towing products and accessories are intended to be installed by Blue Ox® Dealers who are familiar with our products and have the equipment and knowledge necessary to do “fit work”. If needed, Blue Ox® Dealers can be found at www.blueox.com or by contacting our Technical Service Department at (402) 385-3051.
2. Many Blue Ox® baseplates are designed to use existing holes and hardware to mount the baseplate to the towed vehicle. Even though bolts are there, do not assume they are adequate for baseplate mounting. Always use the hardware supplied in the hardware kit and existing hardware as specified in the installation instructions.

Attachment Tab Height: 16”

Attachment Tab Width: 35.25”

Serial Number

Bolt Torque Specifications

Torque in Foot-Pounds for Inch Bolts

Bolt Size	Grade 5	Grade 8
1/4”	10	14
5/16”	19	29
3/8”	33	47
7/16”	54	78
1/2”	78	119
5/8”	154	230
3/4”	257	380

Bolt Torque Specifications

Torque in Foot-Pounds for Metric Bolts

Bolt Size	Grade 8.8	Grade 10.9
6MM	6	8
8MM	16	22
10MM	31	40
12MM	54	70
14MM	89	117
16MM	161	230
18MM	222	318



If the front of your vehicle looks different than this, please contact us at (402)385-3051.

WARNING

Failure to read and follow these instructions could result in separation of the towed vehicle from the tow bar, causing property damage, loss of towed vehicle, personal injury or death.

Reference your vehicle owner’s manual for manufacturer’s towing specifications.

BX2673

2016-2018 Lincoln MKX (Includes ACC, EcoBoost, & Shutters) 2015-2018 Ford Edge Sport (Includes ACC & Shutters) (No 2.0L EcoBoost) Installation Instructions

Instruction Notes: The fascia is removed and reinstalled for the baseplate installation. Some drilling and trimming is required.

Place all components that are removed on a flat, sturdy surface. All items will be reinstalled unless otherwise noted after the baseplate is installed.

The dimensional variations between otherwise identical vehicles can be considerable. While the baseplate was designed for easy installation, it may be necessary to tailor the baseplate slightly to compensate for vehicle manufacturer's tolerances.

The BX8848 Tail Light Wiring Kit is recommended for this vehicle.

NOTICE

- Handling of some cosmetic parts when installing this product may require the use of protective covers, rags, specialty tools, etc. to prevent damage.
- When using power drills be aware of the dangers of torque and drill bit length.
- When using a reciprocating saw be aware of objects behind the cutting surface.
- Use a good quality paint to spray cut edges of frame to prevent rusting.
- Be sure that **ALL** electrical connections are plugged in and accessories are functioning properly before reinstalling the fascia.
- The baseplate is computer tested to your vehicle's GVWR, exceeding this weight will void the manufacturer's warranty.
- Be sure to use a sufficient amount of Loctite® Red on all bolt threads before tightening. Tighten all bolts according to the torque chart provided unless specified.
- Dealer or installer be certain the user receives these instruction sheets.
- If the baseplate is in an accident, it must be replaced. **DO NOT** use it again! An accident can cause unseen damage and using it again could result in more damage or serious injury. **DO NOT** use the baseplate if it is damaged or missing parts.

BX2673

2016-2018 Lincoln MKX (Includes ACC, EcoBoost, & Shutters) 2015-2018 Ford Edge Sport (Includes ACC & Shutters) (No 2.0L EcoBoost) Installation Instructions

Tools Required

Utility Knife
Flat Screwdriver
Torque Wrench
Drill
Loctite® RED
1/8" Drill Bit
3/8" Drill Bit
1/2" Drill Bit
5.5 MM Socket
7MM Socket
8MM Socket
10MM Socket
7/16" Socket
7/16" Wrench
9/16" Socket
9/16" Wrench
3/4" Socket
3/4" Wrench
T25 Torx
T30 Torx
5/16" Nut Driver
1-1/4" Hole Saw
2-1/4" Hole Saw

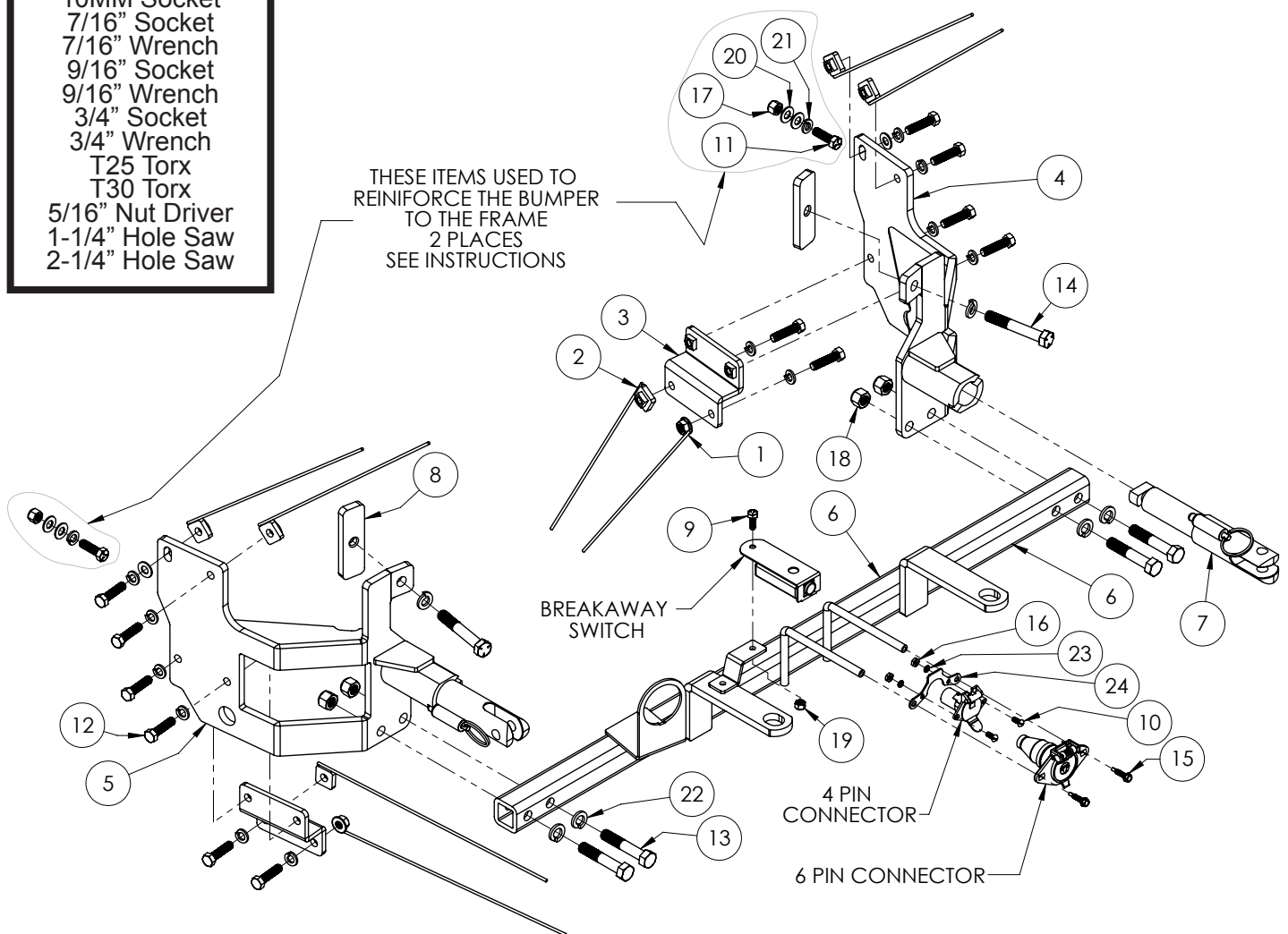

BX2673

2016-2018 Lincoln MKX (Includes ACC, EcoBoost, & Shutters) 2015-2018 Ford Edge Sport (Includes ACC & Shutters) (No 2.0L EcoBoost) Installation Instructions

Item No.	Part No.	Description	Qty.
1.....	61-4978.....	3/8"-16 Whiz Nut w/ 14" Wire	2
2.....	61-5208.....	3/8"-16 Nut Plate w/ 14" Wire	6
3.....	61-7681.....	Support Plate.....	2
4.....	61-7906.....	BX2673 Baseplate, DS.....	1
5.....	61-7914.....	BX2673 Baseplate, PS.....	1
6.....	61-7915.....	BX2673 Baseplate, Center.....	1
7.....	62-3469.....	Attachment Tab Assembly with Hole	2
8.....	102-7749.....	3/8" x 1-1/4" x 4" Flat w/ 1/2" Tapped Hole	2
9.....	201-0050.....	1/4"-20 x 3/4" Hex Head Bolt, Grade 5, ZP	1
10.....	201-0192.....	#10-32 1/2" Round Slotted Head Screw.....	2
11.....	201-0368.....	3/8"-16 x 1-1/4" Hex Head Bolt, Grade 5, ZP	2
12.....	201-0440.....	3/8"-16 x 1-1/2" Hex Head Bolt, Grade 5, ZP	12
13.....	201-0473.....	1/2"-13 x 2-3/4" Hex Head Bolt, Grade 5, ZP	4
14.....	201-0799.....	1/2"-13 x 3-1/4" Hex Head Bolt, Grade 5, ZP	2
15.....	201-0979.....	#12-14 x 1" Self Drilling Screw, ZP.....	2
16.....	202-0047.....	#10-32 Hex Nut	2
17.....	202-0090.....	3/8"-16 Hex Nylon Insert Lock Nut, ZP.....	2
18.....	202-0094.....	1/2"-13 Hex Nylon Insert Lock Nut, ZP	4
19.....	202-0102.....	1/4"-20 Hex Nylon Nut, ZP	1
20.....	203-0003.....	3/8" Flat Washer, ZP.....	6
21.....	203-0010.....	3/8" Lock Washer, ZP	14
22.....	203-0012.....	1/2" Lock Washer, ZP	6
23.....	203-0054.....	#10 Lock Washer, ZP	2
24.....	299-0685.....	4-Way Bracket.....	1
25.....	226-0049(not shown).....	Class IV Safety Cables.....	2
26.....	229-0512(not shown).....	1/2" Quicklink, ZP	2
27.....	290-0437(not shown).....	Black Cap Plug Receiver.....	2

Important:

Use only genuine factory replacement parts on your baseplate. Do **NOT** substitute homemade or non-typical parts. If a bolt is lost or in need of replacement, for your safety and the preservation of your baseplate, be sure to use a replacement bolt of the same grade (In most cases it will be Grade 5, please reference the parts list above). Replacement parts may be ordered through your nearest Blue Ox® Dealer or Distributor. Failing to follow and/or altering these installation instructions in either installation or required equipment will void the manufacturer's warranty. Towing behind a non-motorized vehicle will void the warranty.

BX2673

2016-2018 Lincoln MKX (Includes ACC, EcoBoost, & Shuttters) 2015-2018 Ford Edge Sport (Includes ACC & Shuttters) (No 2.0L EcoBoost) Installation Instructions

2016-2018 Lincoln MKX Installation Instructions

(See page 12 for the 2015-2018 Ford Edge Installation Instructions)

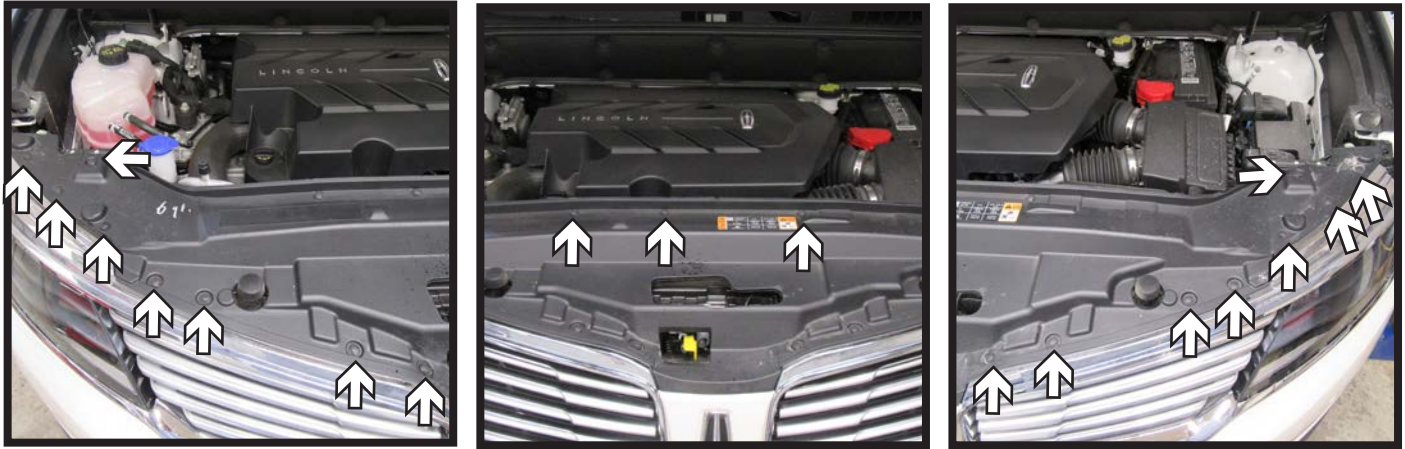

1. Remove the five (19) push pins from along the edge of the fascia. There are eight (8) on each side and three (3) in top middle. Remove top cover.

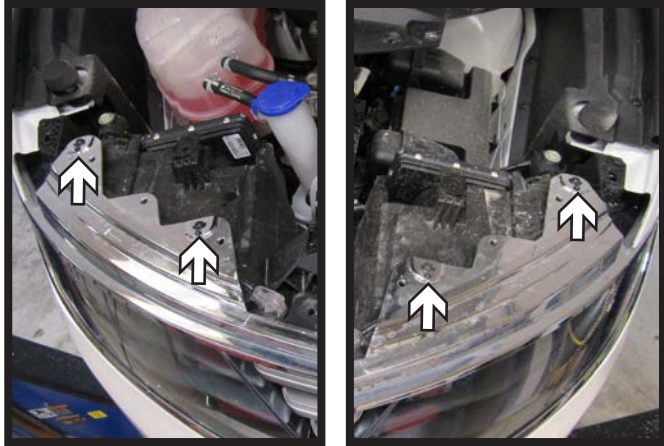

2. Using a T25 Torx, remove the four (4) screws from above the headlights. There are two (2) on each side.

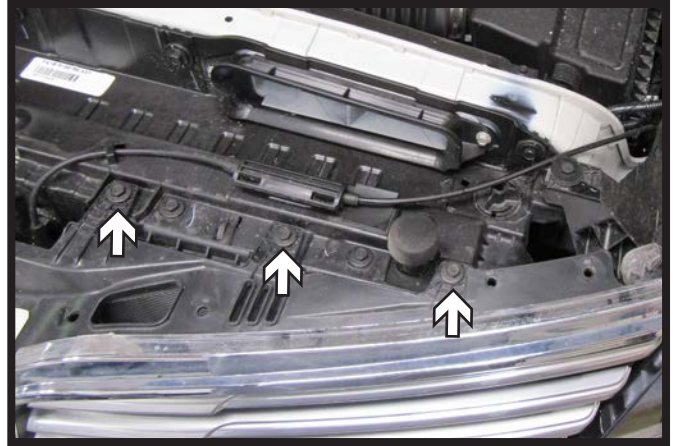

3. Using a 10MM socket remove the three (3) bolts from the top of the fascia. Do this on both side of the vehicle.

BX2673

2016-2018 Lincoln MKX (Includes ACC, EcoBoost, & Shutters) 2015-2018 Ford Edge Sport (Includes ACC & Shutters) (No 2.0L EcoBoost) Installation Instructions



4. Remove the five (5) push pins from along the edge of the wheel well. Do this on both sides of the vehicle.



5. Pull the wheel well liner back and remove the three (3) bolts using a 8MM socket. Do this for both sides of the vehicle.

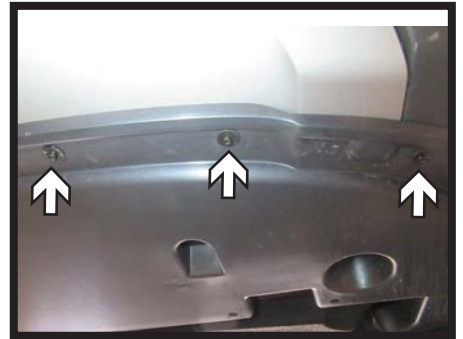
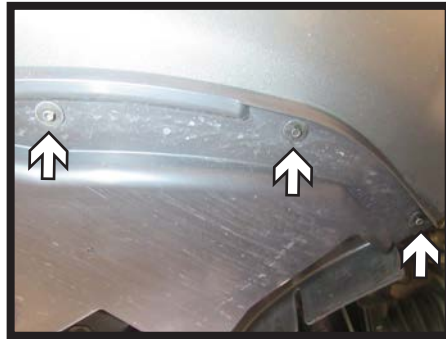
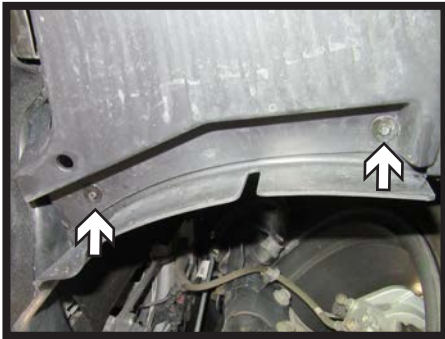

6. Using a 5.5MM socket, remove the eighteen (18) screws from the underside of the fascia. There are eight (8) on each side and two (2) in the center.

BX2673

2016-2018 Lincoln MKX (Includes ACC, EcoBoost, & Shutters) 2015-2018 Ford Edge Sport (Includes ACC & Shutters) (No 2.0L EcoBoost) Installation Instructions

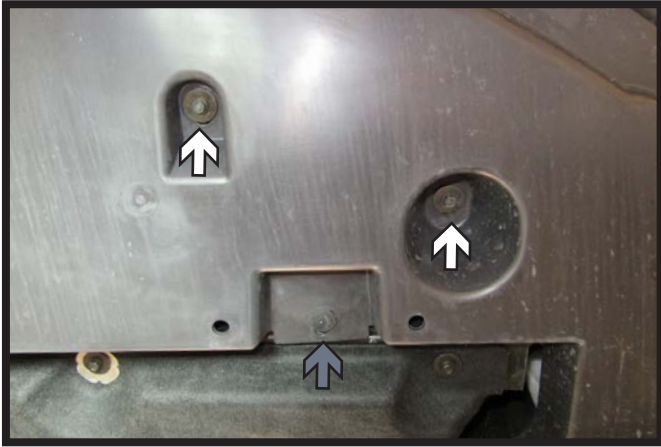

7. Using a 7MM socket remove the two (2) bolts (white) and one (1) push pin (gray) from the belly pan. Do this on both sides of the vehicle. Remove belly pan.



8. Unplug electrical cable on the underside of the fascia. If the vehicle has a plug on the passenger side of the vehicle as shown in insert, will need to unplug the engine block heater as indicated (gray) and remove. Then remove the fascia.

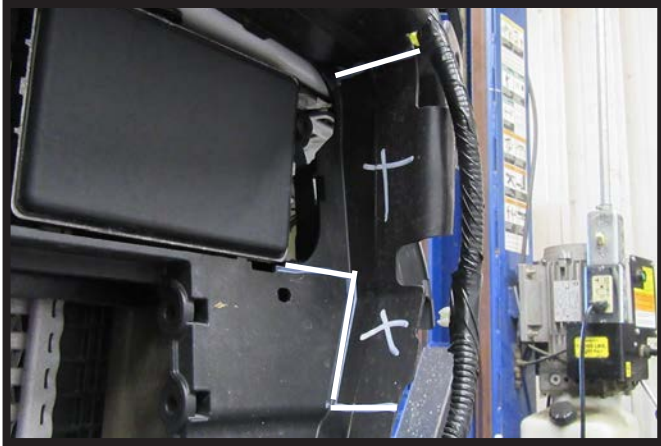

9. Using a utility knife remove the indicated areas on the driver side of the vehicle.

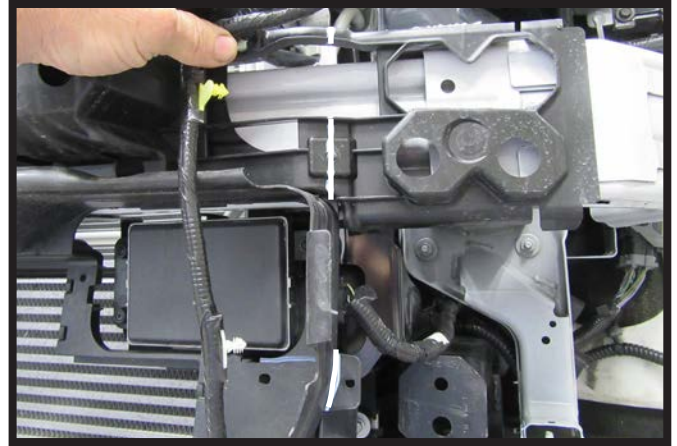

10. On the driver side of the vehicle remove the wiring harness from the push pin bracket. Using a utility knife remove the indicated areas.

BX2673

2016-2018 Lincoln MKX (Includes ACC, EcoBoost, & Shutters) 2015-2018 Ford Edge Sport (Includes ACC & Shutters) (No 2.0L EcoBoost) Installation Instructions

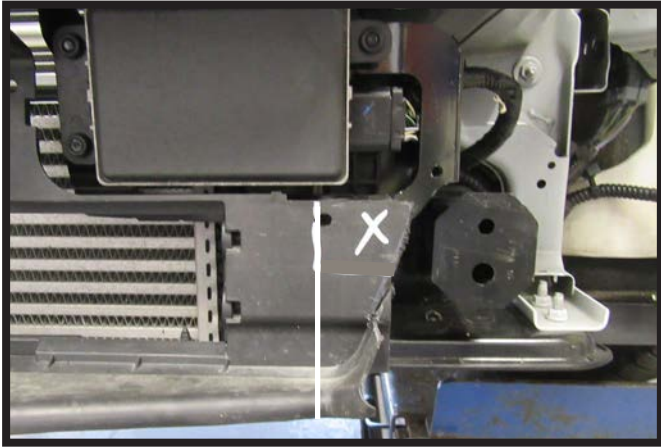

11. Using a utility knife remove the indicated area on the driver side of the vehicle.



12. Using a utility knife remove the indicated area above the adaptive cruise control sensor on the driver side of the vehicle.

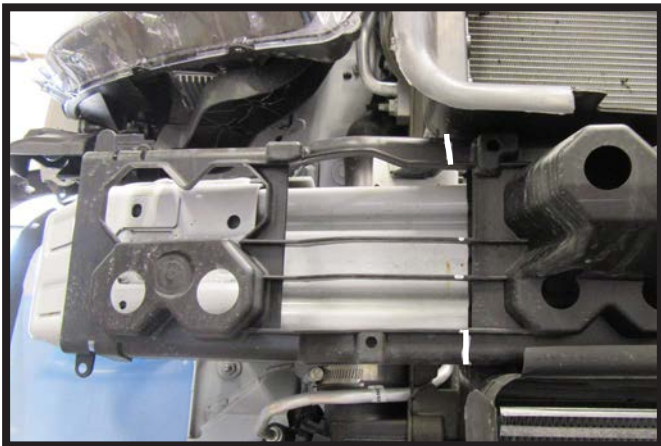

13. Using a utility knife remove the indicated areas on the passenger side of the vehicle.

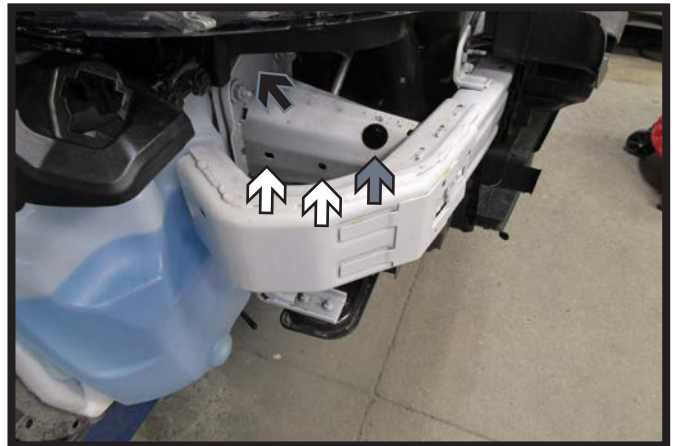

14. Using a 3/8" drill bit drill two (2) holes (white) as indicated in the frame then using a 1-1/4" drill bit drill one (1) access hole (gray). Then drill a 3/8" hole and insert one (1) 3/8" bolt (black) as indicated to reinforce the bumper to the frame. Do this on both sides of the vehicle.

BX2673

2016-2018 Lincoln MKX (Includes ACC, EcoBoost, & Shutters) 2015-2018 Ford Edge Sport (Includes ACC & Shutters) (No 2.0L EcoBoost) Installation Instructions



15. Remove the indicated foam pieces from both sides of the vehicle.

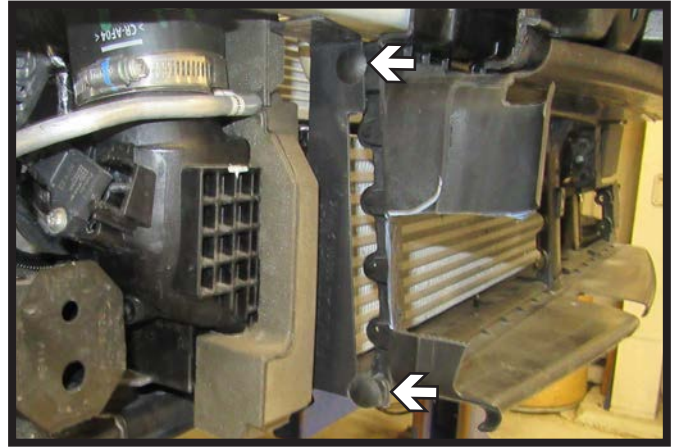

16. Remove the two (2) push pins and then remove the back plastic piece to allow baseplate to fit.
Note: If your vehicle has shutters you will need to remove the bottom two (2) shutters for the baseplate to fit.



17. Using a 1-1/4" drill bit drill one (1) hole as indicated. Do this on both sides of the vehicle.



18. Hold up the side bracket and start the top two (2) 3/8" bolts. Use a lock washer with the front bolt. For the back bolt use a flat washer and a lock washer. Make sure the bracket is level and tighten. Do this on both sides of the vehicle.

**** Use Loctite® Red on all bolt threads and tighten all bolts to the appropriate torque.**

BX2673

2016-2018 Lincoln MKX (Includes ACC, EcoBoost, & Shutters) 2015-2018 Ford Edge Sport (Includes ACC & Shutters) (No 2.0L EcoBoost) Installation Instructions

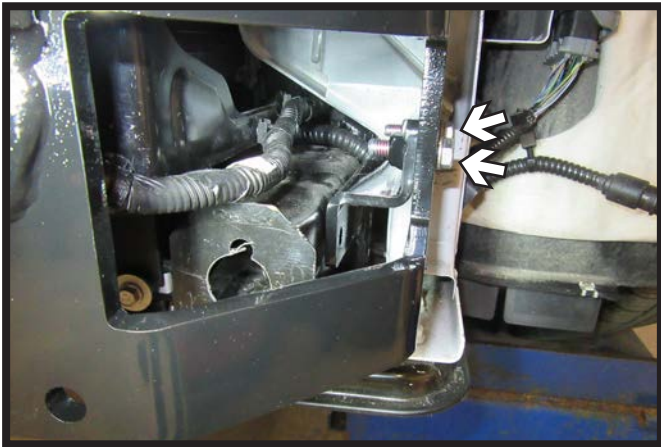

19. Using two (2) 3/8" bolts attach the Z bracket to the side plate as indicated.

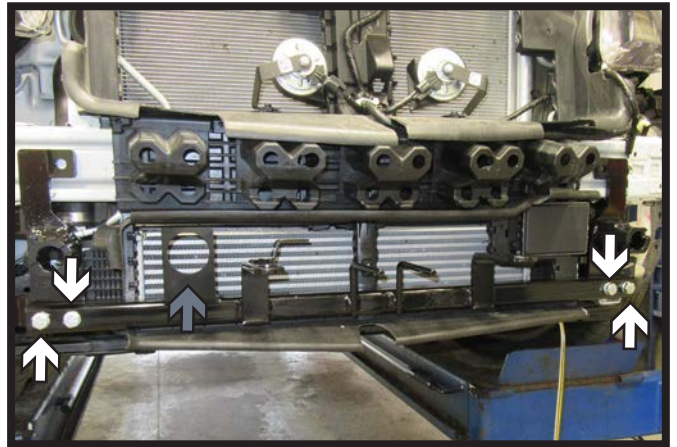

20. Using four (4) 1/2" x 2-3/4" bolts with lock washer and nylon lock nut attach the center cross bar to the side plates. If the holes do not completely line up, ream out holes with a drill bit.

Note: The center bracket (gray arrow) allows for reinstallation of factory engine block heater if vehicle is equipped with this feature.

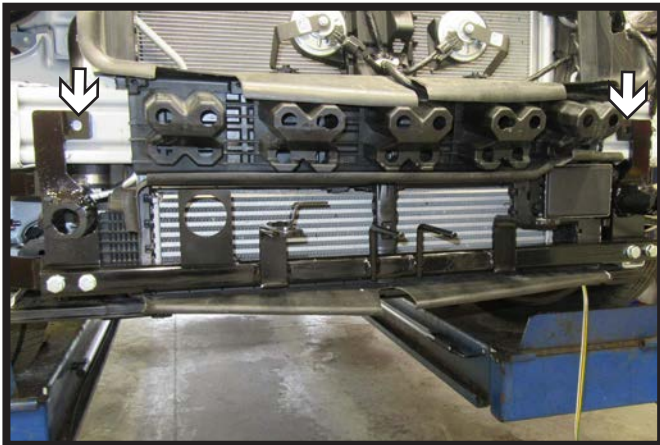

21. Using a 1/2" drill bit drill out top two (2) holes one (1) on each side. Metal is extremely hard so may need to start with a 1/4" drill bit then work up to a 3/8" drill bit and then eventually use a 1/2" drill bit to create the holes. Make sure to drill slowly.

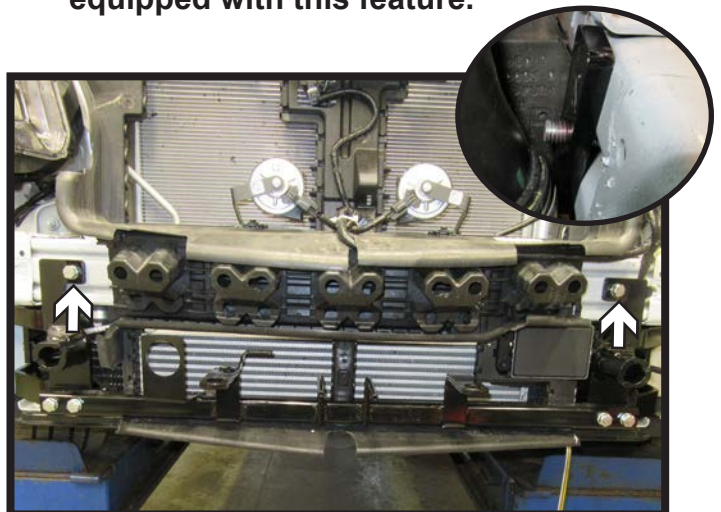

22. Insert 1/2" bolts with spacers on the back side. If the spacer cannot be attached perfectly up and down, may need to angle spacer slightly to get it to fit.
Optional: If vehicle has an engine block heater reinstall at this time.

BX2673

2016-2018 Lincoln MKX (Includes ACC, EcoBoost, & Shutters) 2015-2018 Ford Edge Sport (Includes ACC & Shutters) (No 2.0L EcoBoost) Installation Instructions

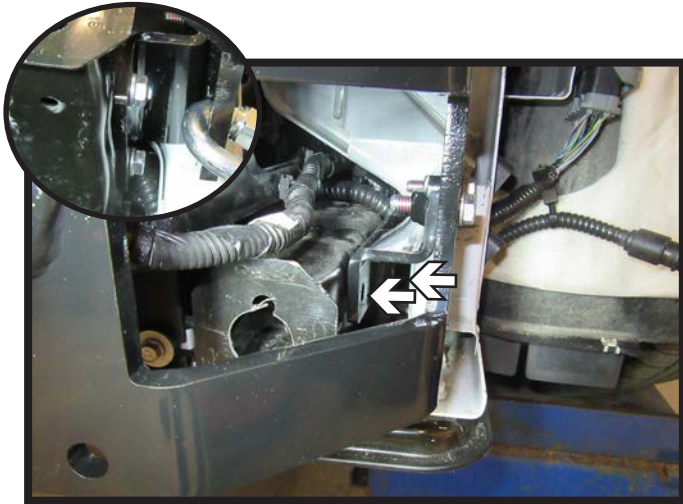

23. Before attaching the safety cables drill out bottom two (2) indicated holes using a 3/8" drill bit. Then insert two (2) 3/8" bolts with lock washers. Do this on both sides of the vehicle.



24. Attach the permanent baseplate safety cables to the provided convenience link on the baseplate. The photo above shows the recommended installation of the cables to frame of vehicle. Additional options may interfere with suggested mounting; in this case, secure the cables to a solid piece of the frame as described in the General Information sheet. Be sure the safety cables do not rub against any hoses or moving parts. Do this on **BOTH** sides of the vehicle.



25. **Optional:** If there is an electrical plug for the engine block heater on the passenger side of the vehicle the following piece will need to be removed from the grill area as indicated.



26. Hold the fascia as close to its original position, mark and trim the fascia around the attachment tabs. Reinstall the fascia and fascia cover. Make sure to reconnect all electrical connections.

BX2673

2016-2018 Lincoln MKX (Includes ACC, EcoBoost, & Shutters)
2015-2018 Ford Edge Sport (Includes ACC & Shutters) (No 2.0L EcoBoost)
Installation Instructions

2015-2018 Ford Edge Installation Instructions)

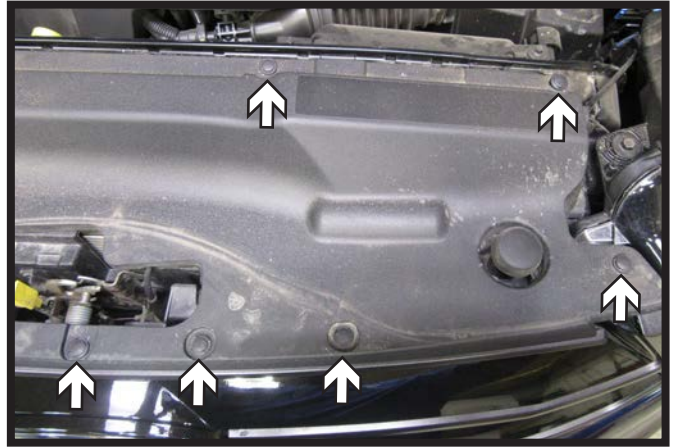
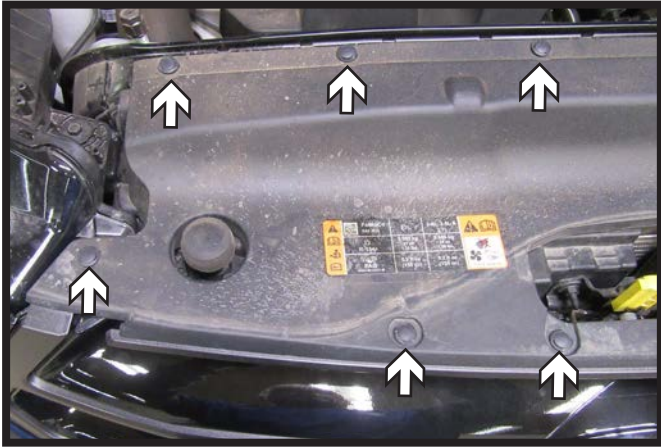

1. Remove the twelve (12) push pins along the top of the fascia cover. Set fascia cover aside to be reinstalled later.

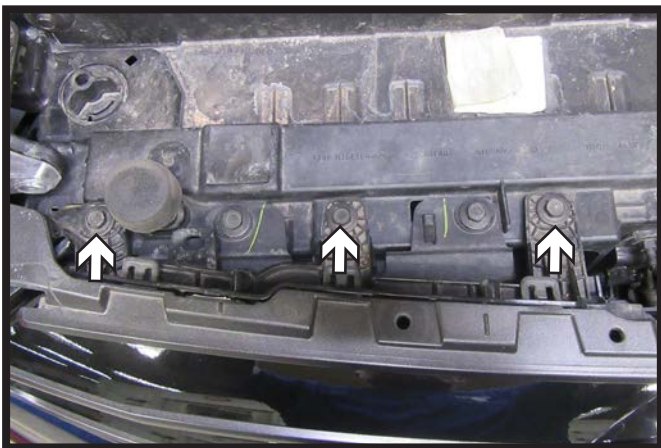

2. Using a 10MM socket, remove the six (6) bolts from the top of the fascia. There are three (3) on each side.
3. Using a 10MM socket remove the two (2) bolts (white) and one (1) push pin (gray) from the top of the headlight. Disconnect all electrical connections and set headlight aside. Do this on both sides of the vehicle.

BX2673

2016-2018 Lincoln MKX (Includes ACC, EcoBoost, & Shuttters) 2015-2018 Ford Edge Sport (Includes ACC & Shuttters) (No 2.0L EcoBoost) Installation Instructions

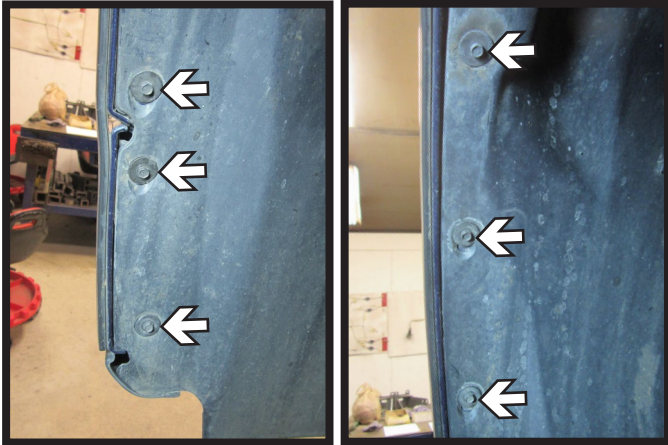

4. Using a 5.5MM socket, remove the six (6) bolts from the edge of the wheel well. Do this on both sides of the vehicle.

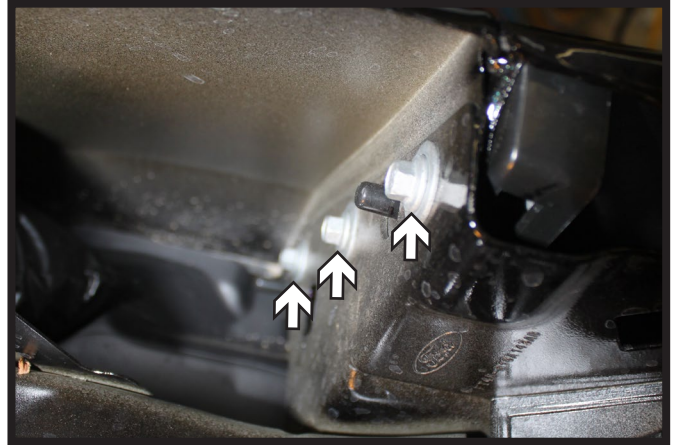

5. Using a 8MM socket, remove the three (3) bolts from the fascia/fender joint underneath where the headlight was. Do this on both sides of the vehicle.



6. Using a 5.5MM socket, remove the ten (10) bolts from the underside of the fascia. There are three (3) on each side and four (4) in the middle. Pull the corners of the fascia away from the vehicle disconnecting any electrical connections and set the fascia aside to be reinstalled later.

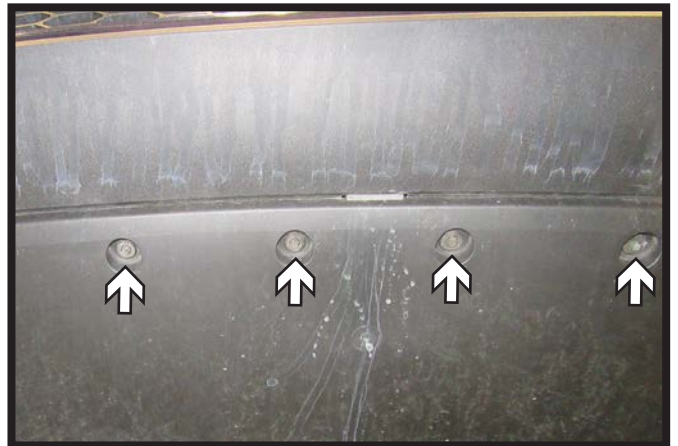

BX2673

2016-2018 Lincoln MKX (Includes ACC, EcoBoost, & Shutters) 2015-2018 Ford Edge Sport (Includes ACC & Shutters) (No 2.0L EcoBoost) Installation Instructions



7a. Unsnap the fascia by the headlight locations. Pull the corners of the fascia away from the vehicle disconnecting any electrical connections and set the fascia aside.



7b. **Shutter Models without ACC Only:** Remove the shield on the driver side next to the shutter support.



8a. Using a reciprocating saw, trim out the section of shielding as shown.

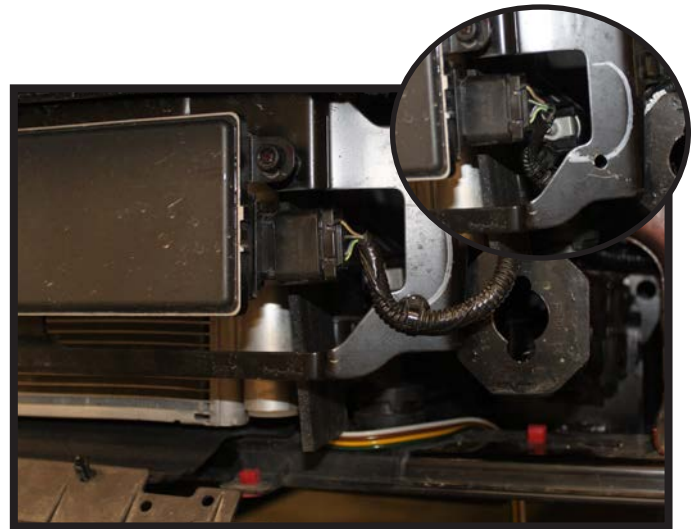

8b. **ACC Models:** Disconnect the ACC sensor wiring loom and re-route it in behind the metal framing to protect it from rubbing on the baseplate.

BX2673

2016-2018 Lincoln MKX (Includes ACC, EcoBoost, & Shutters) 2015-2018 Ford Edge Sport (Includes ACC & Shutters) (No 2.0L EcoBoost) Installation Instructions

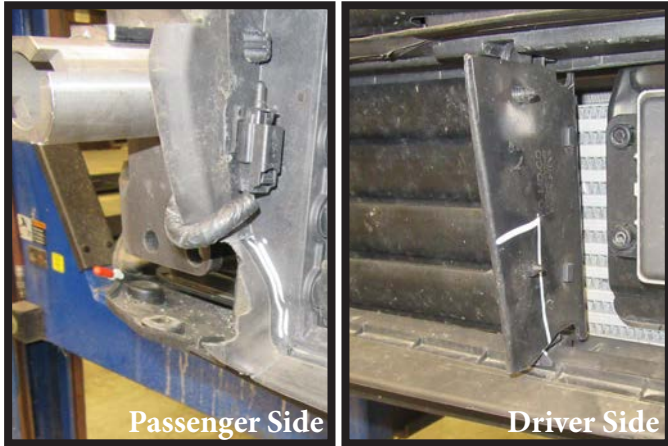

9. Trim the indicated areas near the shutters as shown on both sides of the vehicle.

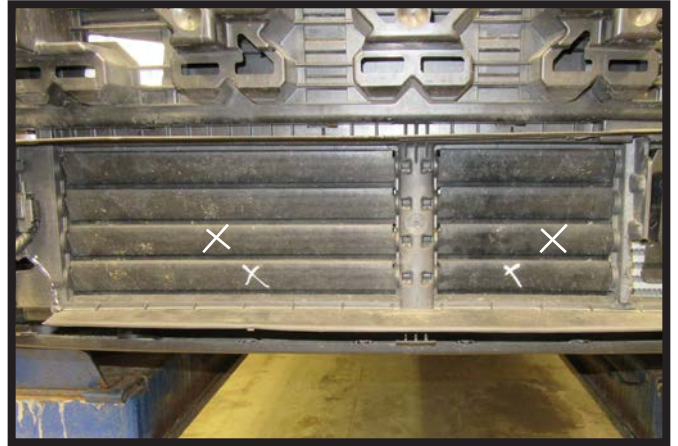

10. Remove the bottom two (2) shutters on the vehicle to allow room for the baseplate.

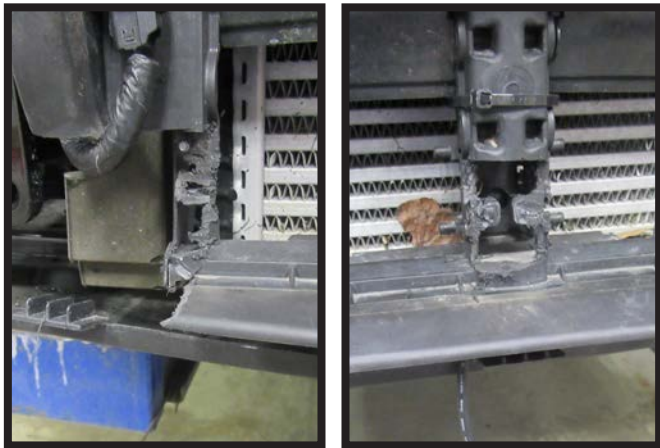

11. Trim the shutter housing on both sides of the vehicle and in the middle as shown to allow room for the baseplate cross member.

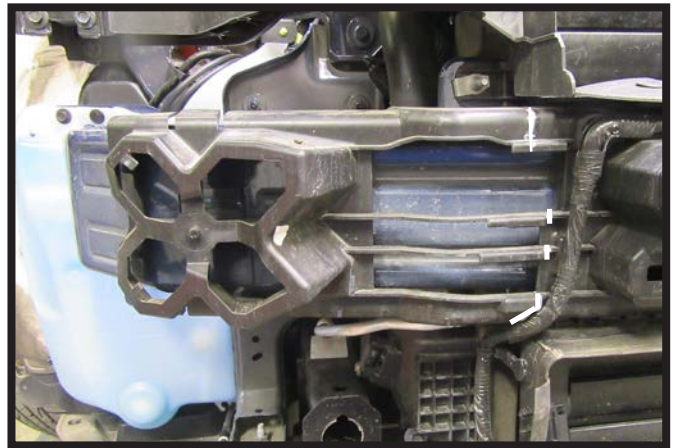

12. Using a reciprocating saw, cut the corner plastic piece off of the driver and passenger side where marked and remove plastic piece.

BX2673

2016-2018 Lincoln MKX (Includes ACC, EcoBoost, & Shutters)
2015-2018 Ford Edge Sport (Includes ACC & Shutters) (No 2.0L EcoBoost)
Installation Instructions

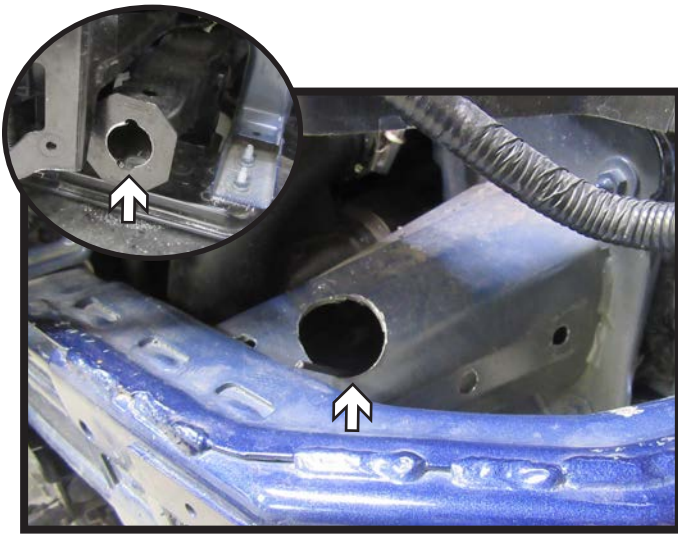

13. Using a 1-1/4" hole saw, drill access holes in the side of the frame as shown and in the face of the lower support (inset). Do this on both sides of the vehicle.

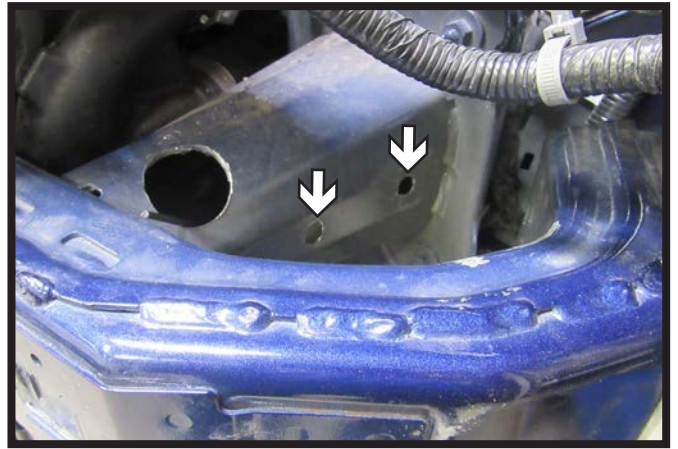

14. Using a 3/8" drill bit, ream out the rear existing hole. Do this on both sides of the vehicle.

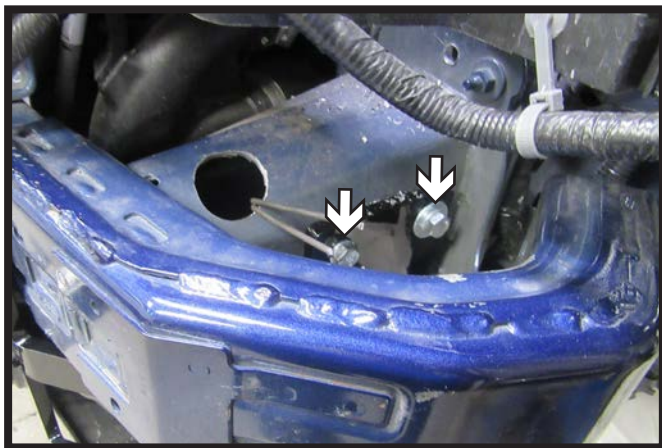

15. Hold up the side bracket and start the top two (2) 3/8" bolts. Use a lock washer with the front bolt. For the back bolt use a flat washer and a lock washer. Make sure the bracket is level and tighten. Do this on both sides of the vehicle.

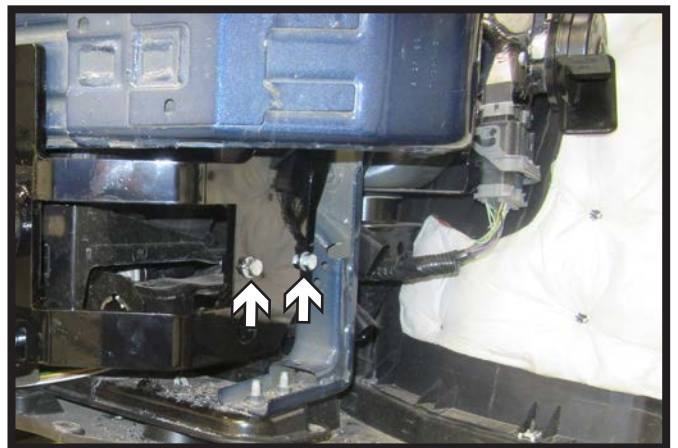

16. Using two (2) 3/8" bolts attach the Z bracket to the side plate as indicated.

**** Use Loctite® Red on all bolt threads and tighten all bolts to the appropriate torque. ****

BX2673

2016-2018 Lincoln MKX (Includes ACC, EcoBoost, & Shutters) 2015-2018 Ford Edge Sport (Includes ACC & Shutters) (No 2.0L EcoBoost) Installation Instructions

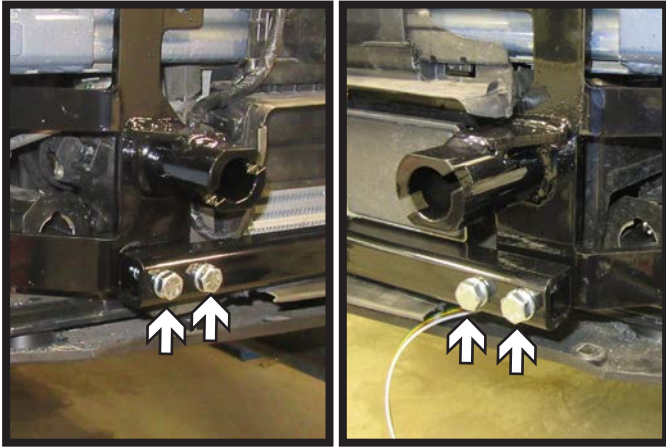

17. Using four (4) 1/2" x 2-3/4" bolts with lock washer and nylon lock nut attach the center cross bar to the side plates. If the holes do not completely line up, ream out holes with a drill bit.

**** Use Loctite® Red on all bolt threads and tighten all bolts to the appropriate torque.**

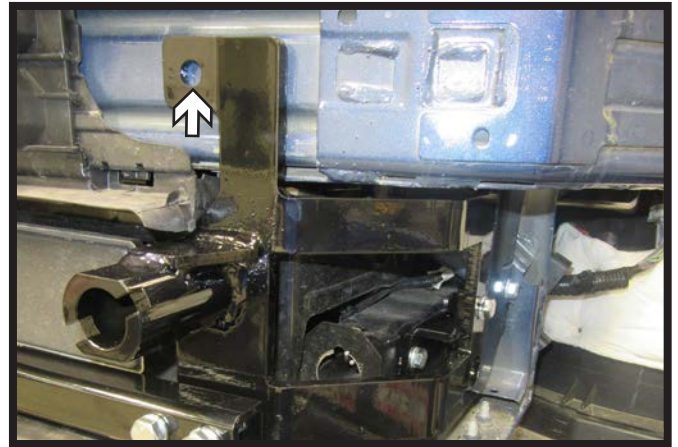

18. Using a 1/2" drill bit drill out top two (2) holes, one (1) on each side. Metal is extremely hard so may need to start with a 1/4" drill bit then work up to a 3/8" drill bit and then eventually use a 1/2" drill bit to create the holes. Make sure to drill slowly.



19. Insert one (1) 1/2" bolt with spacer on the back side. If the spacer cannot be attached perfectly up and down, may need to angle spacer slightly to get it to fit. Do this on both sides of the vehicle.

**** Use Loctite® Red on all bolt threads and tighten all bolts to the appropriate torque. ****

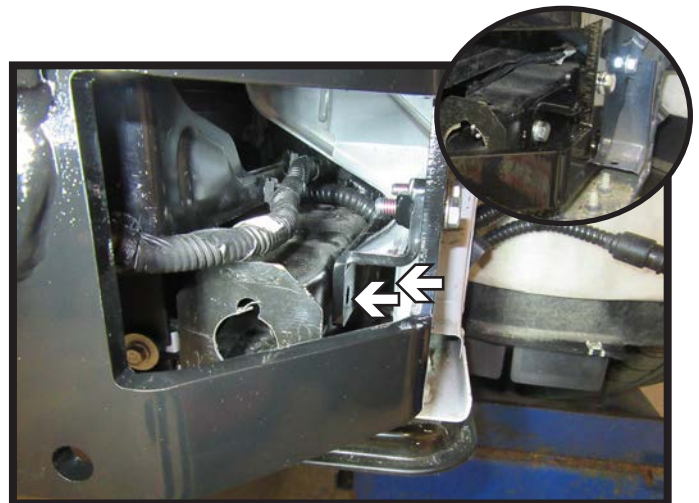

20. Before attaching the safety cables drill out bottom two (2) indicated holes using a 3/8" drill bit. Then insert two (2) 3/8" bolts with lock washers. Do this on both sides of the vehicle.

BX2673

2016-2018 Lincoln MKX (Includes ACC, EcoBoost, & Shutters) 2015-2018 Ford Edge Sport (Includes ACC & Shutters) (No 2.0L EcoBoost) Installation Instructions



21. Attach the permanent baseplate safety cables to the provided convenience link on the baseplate. The photo above shows the recommended installation of the cables to frame of vehicle. Additional options may interfere with suggested mounting; in this case, secure the cables to a solid piece of the frame as described in the General Information sheet. Be sure the safety cables do not rub against any hoses or moving parts. Do this on **BOTH** sides of the vehicle.



22. Hold the fascia as close to its original position, mark and trim the fascia around the attachment tabs. Reinstall the fascia and fascia cover. Make sure to reconnect all electrical connections.

CUSTOMER SERVICE COMMITMENT

Blue Ox® is committed to providing you with exceptional customer care throughout your lifetime with our products. Our team is here to assist you with any questions you may have regarding the performance of your product. Simply call (402) 385-3051 and you can speak with our technical service team.

Additionally, please visit our website to see which rallies our Destination America team will be attending. For a nominal fee, our service technician will service your towing system to ensure it's in proper working condition. Also, as a commitment to our customers, should you visit our factory, you can stay at our full service Blue Ox® campground at no charge along with enjoying a factory tour.

Again, thank you for being our customer and for the confidence you have shown in the performance of our products. It is because of customers like you we enjoy the success we have today.

© 2016 Blue Ox
One Mill Road, Industrial Park
Pender, Nebraska 68047
Phone: (402) 385-3051
Fax: (402) 385-3360
www.blueox.com

General Information

1. Ensure that your product(s) are registered online at www.blueox.com. It is crucial to register your product(s) so that you may be alerted of product offerings, updates, upgrades, maintenance and safety bulletins, and/or recalls.
2. **It is the owner's responsibility to inspect all towing equipment for cracked welds, missing or worn parts and loose bolts before each towing trip.** Be sure to use Loctite® Red on all bolts and tighten to the recommended specifications.
3. **It is the owner's responsibility to hook up all towing equipment per manufacturer's instructions/recommendations.**
4. Remove the attachment tabs when not in use (if applicable).

Notice To Baseplate Installer

1. It is YOUR responsibility to watch for:

- Oil cooler and air conditioner lines
- Electrical wires and hoses
- Missing parts or attaching points on the frame

** If the baseplate is improperly installed and is against a wire or hose, it could cause fluid leaks or electrical shorts some time after the actual baseplate installation.

Permanent Baseplate Safety Cable Installation

Permanent baseplate safety cables are strongly recommended when towing a vehicle with a tow bar. The principle function of the permanent baseplate safety cables is to prevent the towed vehicle from breaking loose in the event the connection between the frame of the towed vehicle and the baseplate fails or becomes disconnected. The cables must be connected from the baseplate to the frame rail or cross member of the vehicle's frame. The illustrations below show the possible arrangements recommended by Blue Ox®. Each permanent baseplate safety cable must have an adequate weight rating for the towing system. The weight rating of the two (2) cables together will not qualify.

Do not mount the permanent baseplate safety cables against wires, hoses or brake lines.

These permanent baseplate safety cables should remain installed as long as the baseplate is installed on the vehicle. Permanent baseplate safety cables are to be used in conjunction with, and NOT a replacement for legally required safety cables attaching the towed vehicle to the towing vehicle.

Option #1

(Baseplates with Convenience Link Tabs)

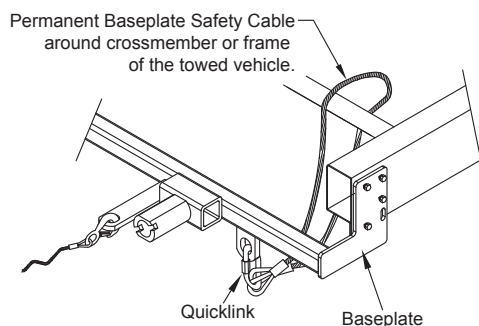

Option #2

(Baseplates with out Convenience Link Tabs)

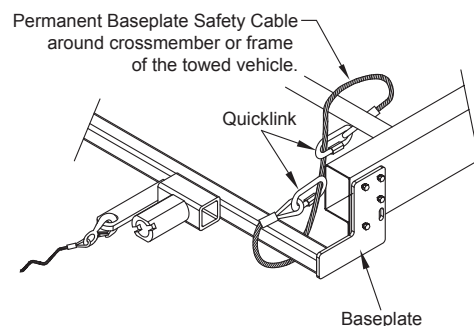

BLUE OX ORIGINAL PURCHASERS THREE YEAR LIMITED WARRANTY

Automatic Equipment Manufacturing Company ("Automatic") warrants to the original (first) retail purchaser that this product, manufactured by Automatic, shall be free from defect in material and workmanship under normal use and service for a period of three years from the date of delivery.

During said three-year period, Automatic will repair or replace any parts that have been returned by the original purchaser, to the factory, transportation prepaid, and in Automatic's sole and absolute opinion found to be defective.

Limitations on Warranty Coverage:

Coverage under this warranty will be valid only if the customer warranty card is returned by the original purchaser within 30 days of purchase.

Coverage under this warranty will be effective only when a copy of the original invoice, showing date and place of purchase, accompanies any claim for warranty. This warranty is NON TRANSFERABLE.

This limited warranty will not cover, in any way or form, any alleged damages caused by incorrect or improper installation, improper use, modification or neglect of product, failure to properly service and maintain, misuse, act of God, accident or failure of the user to follow guidelines contained in the instructional material provided by Automatic.

This warranty does not cover normal wear and tear, paint or rust.

Warrantor assumes no responsibility to the owner for loss of use of product, loss of time, inconvenience or any other damage consequential or otherwise. Including, but not limited to mileage, expense of transporting of product, return shipping expense, mechanics travel time, telephone, road service, towing, and rental during repairs, travel, lodging, loss or damage to personal property or loss of earnings.

REPAIR OR REPLACEMENT AS SET FORTH IN THIS LIMITED WARRANTY IS THE SOLE EXCLUSIVE REMEDY OF THE PURCHASER. AUTOMATIC SHALL NOT BE LIABLE FOR ANY INCIDENTAL OR CONSEQUENTIAL DAMAGES FOR BREACH OF ANY EXPRESS OR IMPLIED WARRANTY ON THIS PRODUCT. EXCEPT TO THE EXTENT PROHIBITED BY APPLICABLE LAW, ANY IMPLIED WARRANTY OF MERCHANTABILITY OR FITNESS FOR A PARTICULAR PURPOSE ON THIS PRODUCT IS LIMITED IN LENGTH TO THE DURATION OF THIS WARRANTY.

Please visit <http://blueox.com/warranty/> to register your warranty

