



# BX2719

## 2011-13 Kia Sorento 2011-12 Hyundai Santa Fe Installation Instructions

Serial Number

Attachment Tab Height: 16-1/2"

Attachment Tab Width: 22-1/4"

Please read BOTH these Installation Instructions and the General Instructions prior to installing or operating this equipment.

- Blue Ox® towing products and accessories are intended to be installed by Blue Ox® Dealers who are familiar with our products and have the equipment and knowledge necessary to do "fit work". If needed, Blue Ox® Dealers can be found at [www.blueox.com](http://www.blueox.com) or by contacting our Customer Care Department at (402) 385-3051.
- Many Blue Ox® baseplates are designed to use existing holes and hardware to mount the baseplate to the towed vehicle. Even though bolts are there, do not assume they are adequate for baseplate mounting. Always use the hardware supplied in the hardware kit and existing hardware as specified in the installation instructions.

**Bolt Torque Specifications**  
Torque in Foot-Pounds for Metric Bolts

Bolt Size	Grade 8.8	Grade 10.9
6MM	6	8
8MM	16	22
10MM	31	40
12MM	54	70
14MM	89	117

**Bolt Torque Specifications**  
Torque in Foot-Pounds for Inch Bolts

Bolt Size	Grade 5	Grade 8
1/4"	10	14
5/16"	19	29
3/8"	33	47
7/16"	54	78
1/2"	78	119
5/8"	154	230



If the front of your vehicle looks different than this, please contact us at (402)385-3051.

**Reference your vehicle owner's manual for manufacturer's towing specifications.**

**! WARNING**

Failure to read and follow these instructions could result in separation of the towed vehicle from the tow bar, causing property damage, loss of towed vehicle, personal injury or death.

BX2719  
2011-13 Kia Sorento  
2011-12 Hyundai Santa Fe  
Installation Instructions

**Instruction Notes:** The fascia, belly pan, air baffle and windshield washer fluid reservoir are removed and reinstalled for the baseplate installation. Some drilling and trimming is required.

Place all components that are removed on a flat, sturdy surface. All items will be reinstalled unless otherwise noted after the baseplate is installed.

The dimensional variations between otherwise identical vehicles can be considerable. While the baseplate was designed for easy installation, it may be necessary to tailor the baseplate slightly to compensate for vehicle manufacturer's tolerances.

The BX8869 Tail Light Wiring Kit is recommended for this vehicle.

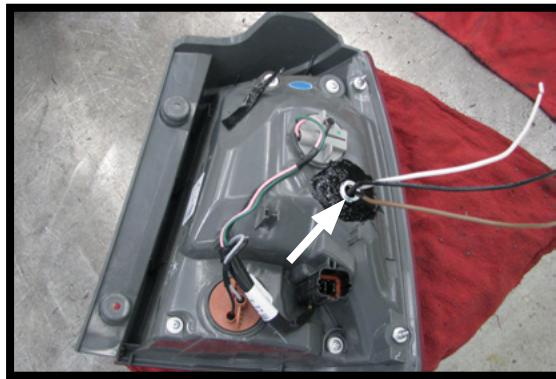

Drill a hole according to the tail  
light wiring kit instructions.

**NOTICE**

- Handling of some cosmetic parts when installing this product may require the use of protective covers, rags, specialty tools, etc. to prevent damage.
- When using power drills be aware of the dangers of torque and drill bit length.
- When using a reciprocating saw be aware of objects behind the cutting surface.
- Use a good quality paint to spray cut edges of frame to prevent rusting.
- Be sure that **ALL** electrical connections are plugged in and accessories are functioning properly before reinstalling the fascia.
- Do not use the towed vehicle for storing luggage, equipment, etc. This may cause you to exceed the towing capacity of the tow bar, baseplate and its accessories.
- Be sure to use Loctite® Red on all bolts before tightening. Tighten all bolts according to the torque chart provided.
- Dealer or installer be certain the user receives these instruction sheet.
- If the baseplate is in an accident, it must be replaced. **DO NOT** use it again! An accident can cause unseen damage and using it again could result in more damage or serious injury. **DO NOT** use the baseplate if it is damaged or missing parts.

**BX2719**  
**2011-13 Kia Sorento**  
**2011-12 Hyundai Santa Fe**  
**Installation Instructions**

**Tools Required**

Large Vise Grip  
 Flat Screwdriver  
 Utility Knife  
 Phillips Screwdriver  
 Torque Wrench  
 Drill  
 Reciprocating Saw  
 Tape Measure  
 Loctite® RED  
 13/32" Drill Bit  
 1-1/4" Hole Saw  
 8MM Socket  
 10MM Socket  
 9/16" Socket  
 9/16" Wrench

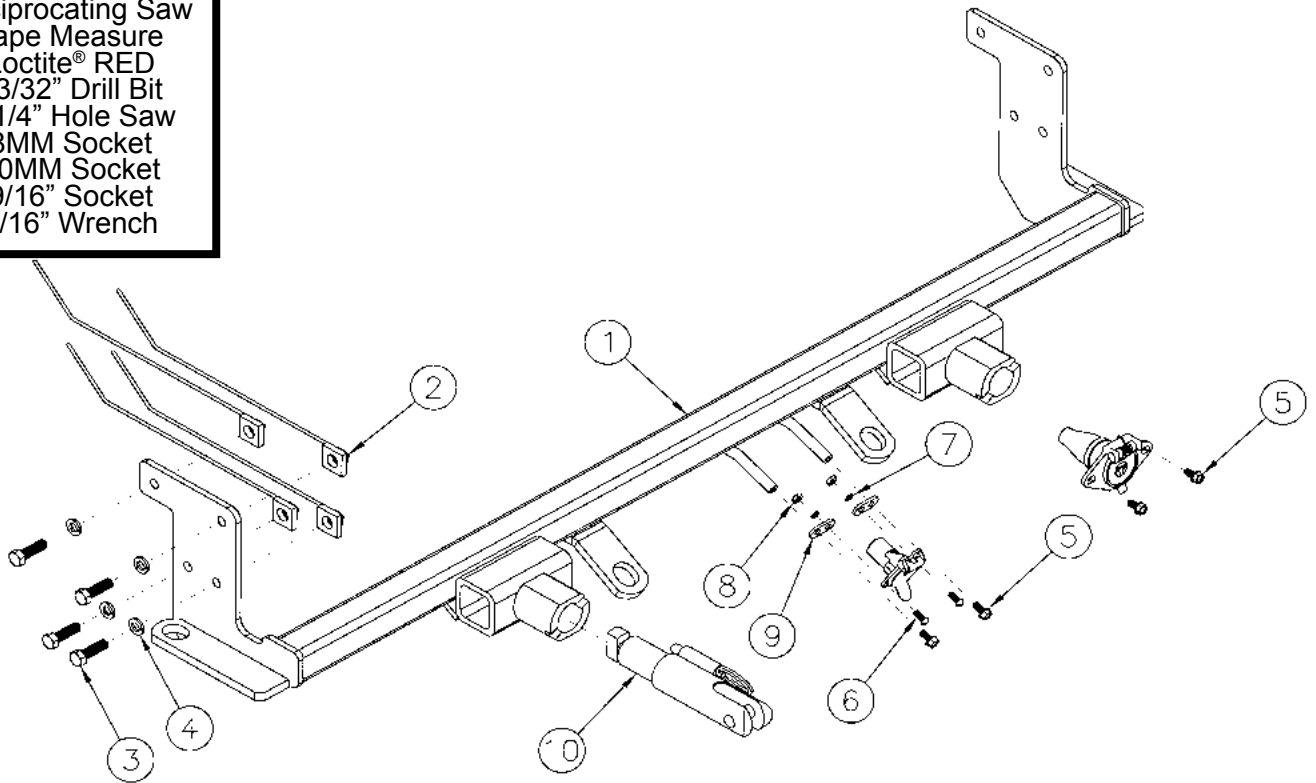

Item No.	Part No.	Description	Qty.
1.....	61-6751 .....	BX2719 Baseplate.....	1
2.....	61-5208 .....	3/8"-16 Nut Plate w/ 14" Wire .....	8
3.....	201-0368 .....	3/8"-16 x 1-1/4" Hex Head Bolt, Grade 5, ZP .....	8
4.....	203-0010 .....	3/8" Lock Washer, ZP .....	8
5.....	201-0553 .....	1/4-20 x 1/2" Hex Wshd Bolt Type F TCS, ZP .....	2
6.....	201-0192 .....	#10-32 1/2" Round Slotted Head Screw.....	2
7.....	203-0054 .....	#10 Lock Washer, ZP .....	2
8.....	202-0047 .....	#10-32 Hex Nut .....	2
9.....	101-5822 .....	4 Way Connector Adapter .....	2
10.....	62-3468 .....	Attachment Tab Assembly with Hole .....	2
11.....	226-0046(not shown) .....	Class III Safety Cables .....	2
12.....	229-0359(not shown) .....	3/8" Quicklink, ZP .....	4
13.....	290-0437(not shown) .....	Black Cap Plug Receiver.....	2

**Important:**

Use only genuine factory replacement parts on your baseplate. Do **NOT** substitute homemade or non-typical parts. If a bolt is lost or in need of replacement, for your safety and the preservation of your baseplate, be sure to use a replacement bolt of the same grade (In most cases it will be Grade 5, please reference the parts list above). Replacement parts may be ordered through your nearest Blue Ox® Dealer or Distributor. Failing to follow and/or altering these installation instructions in either installation or required equipment will void the manufacturer's warranty. Towing behind a non-motorized vehicle will void the warranty.

BX2719  
2011-13 Kia Sorento  
2011-12 Hyundai Santa Fe  
Installation Instructions



1. Using a 10MM socket, remove the screw from the top outer edge of the fascia (gray). Then remove the two (2) push pins (white). Do this on both sides of the vehicle.

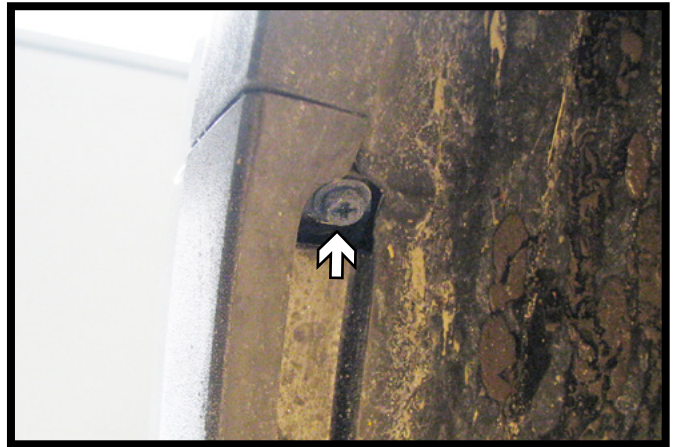

2. Using a 8MM socket, remove the screw from the top edge of the wheel well. Do this on both sides of the vehicle.



3. Remove the two (2) push pins from the underside outer edge of the fascia. Do this on both sides of the vehicle.

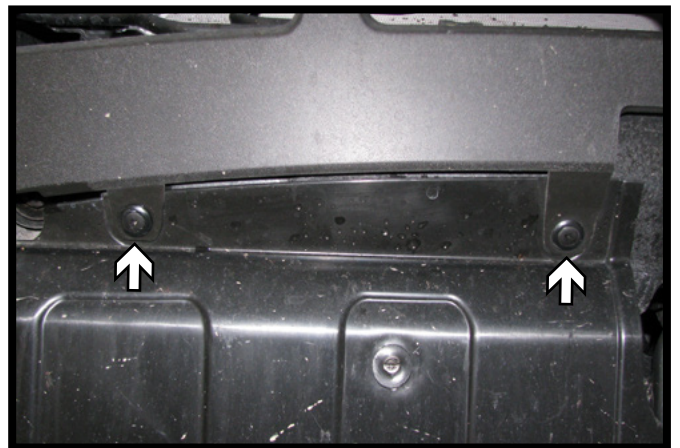

4. Remove the two (2) push pins from the underside inner edge of the fascia. Do this on both sides of the vehicle. Pull the outer top edges of the fascia outwards and pull fascia forward to remove from the vehicle.



BX2719  
2011-13 Kia Sorento  
2011-12 Hyundai Santa Fe  
Installation Instructions

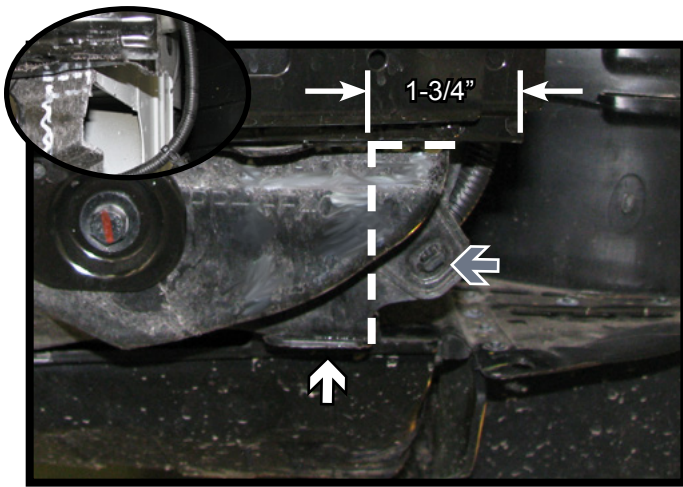

5. Remove the push pin from underneath the bumper attaching the plastic guard. Unsnap the wiring loom from the bracket (gray). Measure over approximately 1-3/4" from edge of the bumper and cut the corner off flush with frame using a reciprocating saw. Do this on both sides of the vehicle.

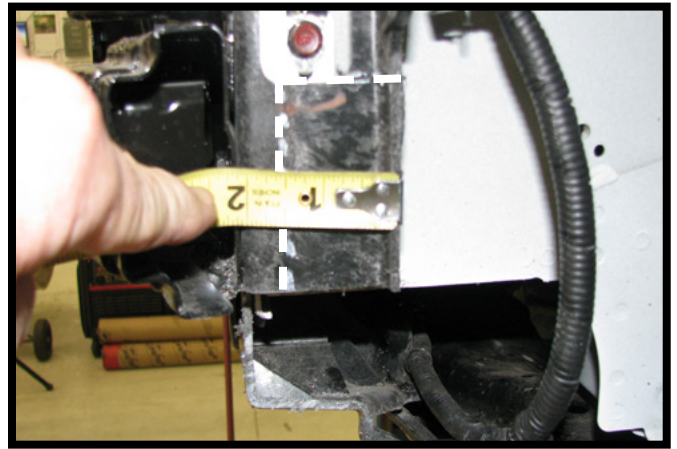

6. On the side of the frame measure over 1-1/2" from the edge and trim the corner of the plate off as shown using a reciprocating saw. Do this on both sides of the vehicle.



7. Disconnect the electrical connections and fluid lines from the washer reservoir. Using a 10MM socket, remove the reservoir bolts and set the washer reservoir aside.

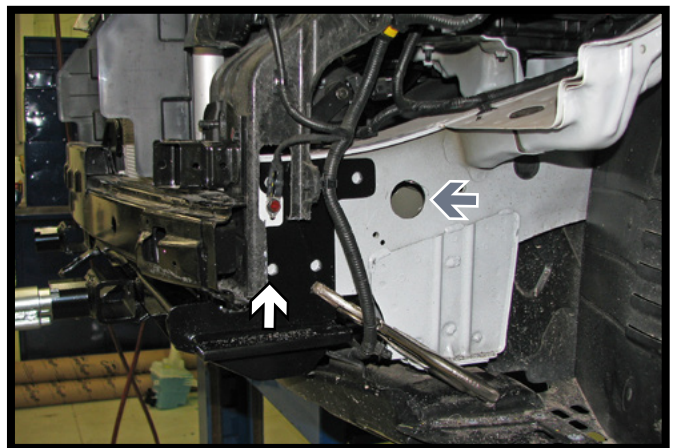

8. Clamp the baseplate into position as close to level as possible as shown. Using a 1-1/4" hole saw, drill a hole into the frame behind the baseplate (gray). Using a 13/32" drill bit drill the lower front hole (white). Do this on both sides of the vehicle.

BX2719  
2011-13 Kia Sorento  
2011-12 Hyundai Santa Fe  
Installation Instructions

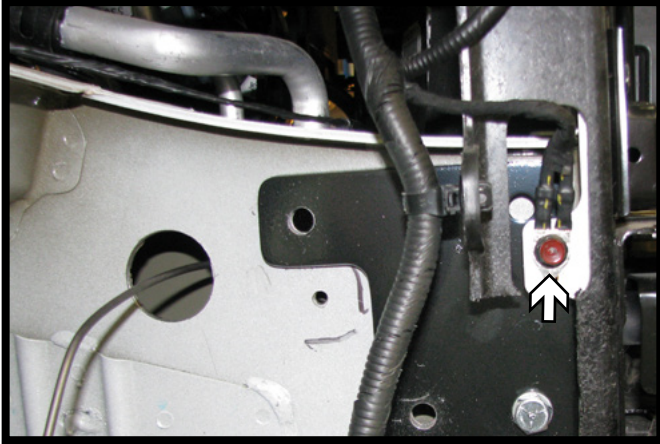

9. Insert a 3/8"-16 x 1-1/4" bolt with lock washer into the front hole and secure with a 3/8"-16 nut plate. Re-level the baseplate and tighten the 3/8" hardware. Temporarily remove the ground strap, and drill the remaining baseplate holes with a 13/32" drill bit. Do this on both sides of the vehicle.

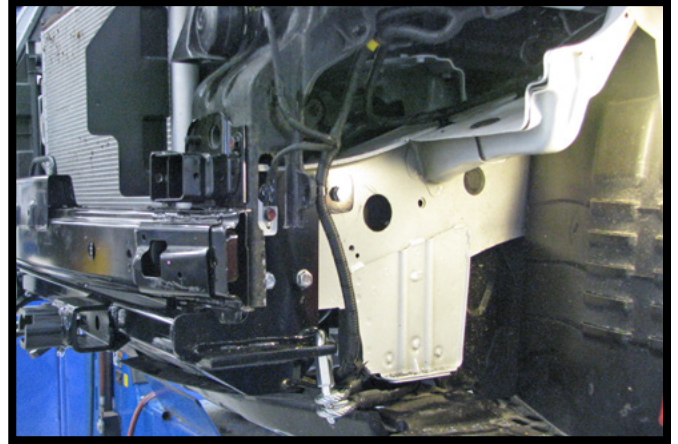

10. Install 3/8"-16 x 1-1/4" bolts with lock washers into the remaining baseplate holes and secure with 3/8"-16 nut plates. Reinstall the grounding strap to the frame. Do this on both sides of the vehicle.

11. Reinstall the washer reservoir.

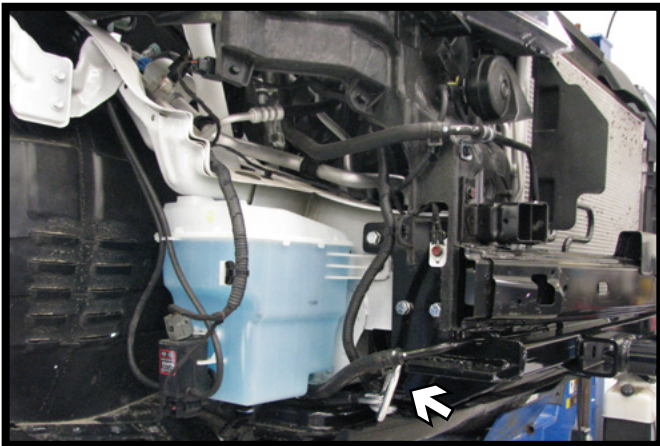

12. Attach the permanent baseplate safety cables to the provided convenience link on the baseplate. The photo beside shows the recommended installation of the cables to frame of vehicle. Additional options may interfere with suggested mounting; in this case, secure the cables to a solid piece of the frame as described in the instructions included with the permanent baseplate safety cables. Be sure the safety cables do not rub against any hoses or moving parts. Do this on **BOTH** sides of the vehicle.

BX2719  
2011-13 Kia Sorento  
2011-12 Hyundai Santa Fe  
Installation Instructions

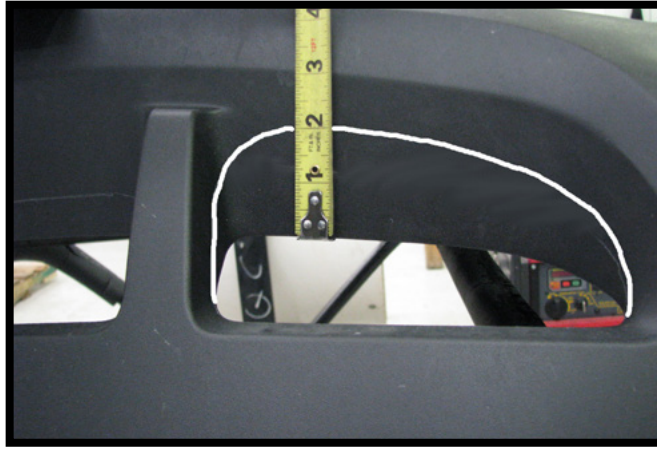

13. Trim the each of the openings in the fascia approximately 2" deep to clear the baseplate. Reinstall the fascia.

## CUSTOMER SERVICE COMMITMENT

Blue Ox® is committed to providing you with exceptional customer care throughout your lifetime with our products. Our team is here to assist you with any questions you may have regarding the performance of your product. Simply call (402) 385-3051 and you can speak with our customer care team.

Additionally, please visit our website to see which rallies our Destination America team will be attending. For a nominal fee, our service technician will service your towing system to ensure it's in proper working condition. Also, as a commitment to our customers, should you visit our factory, you can stay at our full service Blue Ox® campground at no charge along with enjoying a factory tour.

Again, thank you for being our customer and for the confidence you have shown in the performance of our products. It is because of customers like you we enjoy the success we have today.

© 2012 Blue Ox  
One Mill Road, Industrial Park  
Pender, Nebraska 68047  
Phone: (402) 385-3051  
Fax: (402) 385-3360  
[www.blueox.com](http://www.blueox.com)