



Baseplate Installation Instructions

BX3233

2008-09 Pontiac Torrent Installation Instructions

Serial Number

Please read BOTH these Installation Instructions and the General Towing Instructions before attempting to install or operate this equipment.

1. Blue Ox® towing products and accessories are intended to be installed by Blue Ox® Dealers who are familiar with our products and have the equipment and knowledge to do “fit work.” When necessary, Blue Ox® Dealers can be found at www.blueox.us or by contacting our Customer Care Department at (888) 425-5382.

Attachment Tab Height: 13.5”
Attachment Tab Width: 22”

2. Many Blue Ox® Baseplates are designed to use existing holes and hardware to mount the baseplate to the towed vehicle. Even though bolts are there, do not assume they are adequate for baseplate mounting. Always use hardware supplied in the hardware kit or existing hardware specified in the Baseplate Towing Installation Instructions.

Bolt Torque Specifications
Torque in Foot-Pounds per Metric Bolts

Bolt Size	Grade 8.8	Grade 10.9
6MM	6	8
8MM	16	22
10MM	31	40
12MM	54	70
14MM	89	117

Confirm the towability and pre-towing procedures for your vehicle with the owner’s manual or contact the vehicle’s manufacturer for specific towing procedures.

Bolt Torque Specifications
Torque in Foot-Pounds per Inch Bolts

Bolt Size	Grade 5	Grade 8
1/4”	10	14
5/16”	19	29
3/8”	33	47
7/16”	54	78
1/2”	78	119
5/8”	154	230



! WARNING

Failure to read and follow these instructions could result in separation of the towed vehicle from the tow bar, causing property damage, loss of towed vehicle, personal injury or death.

BX3233

2008-09 Pontiac Torrent

Installation Instructions

Parts List

Ref. No.	Qty.	Part #	Description
1	1	61-6540	WLDM'T, BASEPLATE, BX3233
2	6	61-5208	WLDT, NUT PLT, 1/4X1X1, 3/8 BLT WIR
3	2	201-0440	3/8-16 X 1 1/2 HEX BOLT, GRD.5, ZP
4	6	201-0444	3/8-16 X 2 HEX BOLT GRADE 5 ZP.
5	8	203-0010	3/8 LOCK WASHER, ZP
6	2	202-0090	3/8-16 HEX NYL. INS. LOCK NUT, ZP
7	2	201-0553	1/4-20 X 1/2 HX.WSHD.TYPE F TCS, ZP
8	2	201-0192	10-32 X 1/2 SLOT, RD. HD. SCREW
9	2	203-0054	#10 LOCK WASHER
10	2	202-0047	#10-32 HEX NUT
11	2	101-5822	ADAPTER, 4 WAY CONNECTOR
12	2	62-3469	ATT TAB ASSY, REM, SF/LB, 1 HOLE
	2	226-0046	BASEPLATE SAFETY CABLE, 36" CL III (Not Shown)
	2	229-0359	QUICKLINK, 3/8, ZP (Not Shown)
	2	290-0437	RECEIVER, CAP PLUG (BLK) (Not Shown)

Tools Required

7MM Socket	9/16" Socket
Reciprocating Saw	Flat Screw Driver
Utility Knife	13/32" Drill Bit
1/4" Drill Bit	Loctite® RED

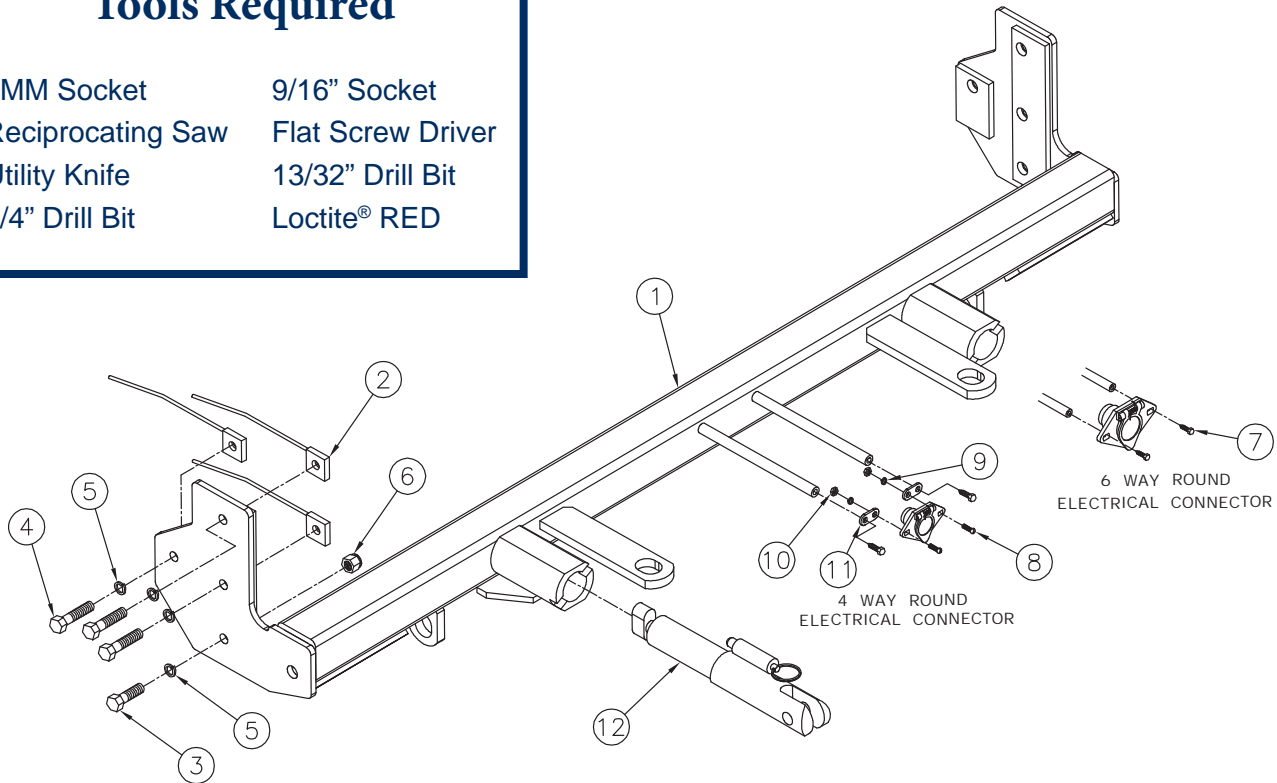

Important:

Use only genuine factory replacement parts on your baseplate. Do **NOT** substitute homemade or non-typical parts. If a bolt is lost or in need of replacement, for your safety and the preservation of your baseplate, be sure to use a replacement bolt of the same grade (In most cases it will be Grade 5, please reference the parts list above). Replacement parts may be ordered through your nearest Blue Ox® Dealer or Distributor.

BX3233

2008-09 Pontiac Torrent

Installation Instructions

Vehicle Weight:

Motorhome mount tow bars are recommended for use with this baseplate. Due to the design of the removable tabs, the RangeFinderII, Adventurer, and Ambassador tow bars can not be used. The Acclaim tow bar may be used, but will not fold and store on the front of the vehicle. Adapters, except the BX8833 and BX88151, can not be used with this baseplate.

Installation Notes: The fascia, guard, bolts and push pins are removed and reinstalled during installation of the baseplate. Drilling is required. Trimming is required.

The dimensional variations between otherwise identical vehicles can be considerable. While the baseplate was designed for easy installation, it may be necessary to tailor the baseplate slightly to compensate for auto manufacturer's tolerances. These minor adjustments may include filing a hole slightly, bending electrical rods and/ or bending end plates.

The BX8869 Bulb & Socket Wiring Kit is recommended for this vehicle.

Installation Instructions:



1. Remove three push pins from the flat plastic piece on top. Set push pins aside to be reinstalled later.



2. Just forward of the front tire, move the wheel well cover, use a 7MM socket to remove the bolt. Do this on both sides and set aside for later reinstallation.

BX3233
2008-09 Pontiac Torrent
Installation Instructions



3. Using a 7MM socket, remove two bolts from the lower edge of the fascia. Do this to both sides of the vehicle. Set bolts aside to be reinstalled later.



4. Using a flat screw driver, remove five push pins from the lower edge of fascia all the way around. Set push pins aside to be reinstalled later.



5. In order to remove the fascia from the vehicle, squeeze the two clips holding the fascia. Do this on both sides. Carefully pull the fascia forward then set aside to be reinstalled later.

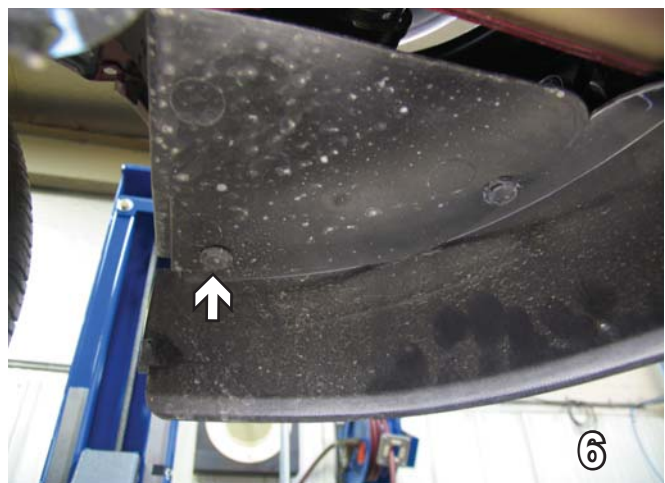

6. Underneath the fascia, use a flat screw driver to remove two push pins. Do this to both sides of the vehicle. Set the push pins aside to be reinstalled later.

7. Underneath the vehicle, remove 3 push pins, in order to remove the black plastic guard. Set the guard and push pins aside to be reinstalled later.

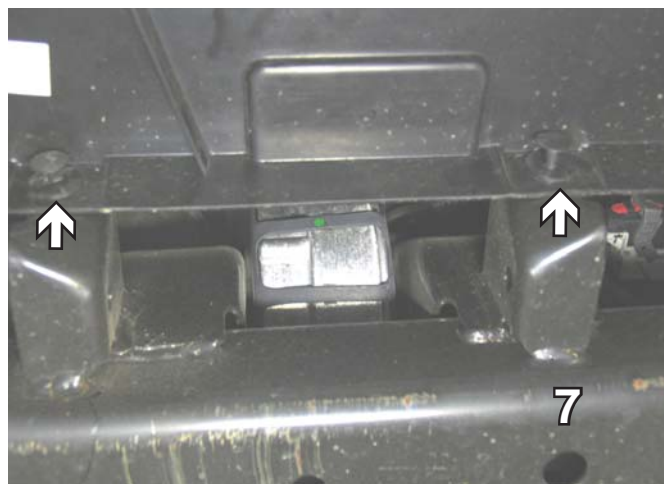

BX3233
2008-09 Pontiac Torrent
Installation Instructions



8. Using a reciprocating saw, trim on the front of the frame under the bumper, as indicated in the photo. Do this to both sides.

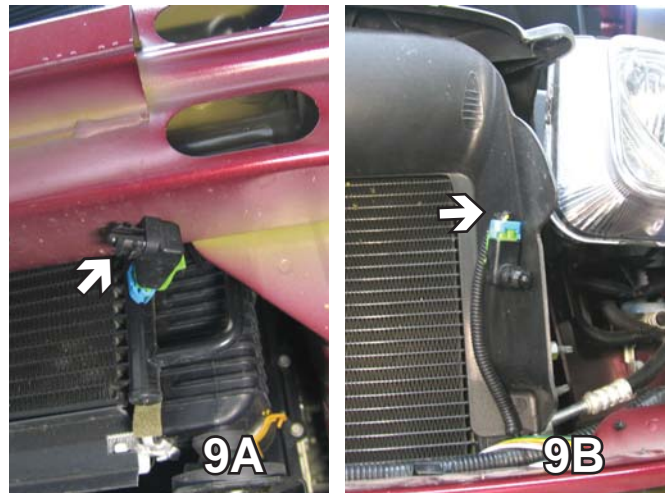

9. The sensor in 9A needs to be moved up to a 1/4" drilled hole shown in 9B.

Using a good quality paint, spray cut edges of frame to prevent rusting.

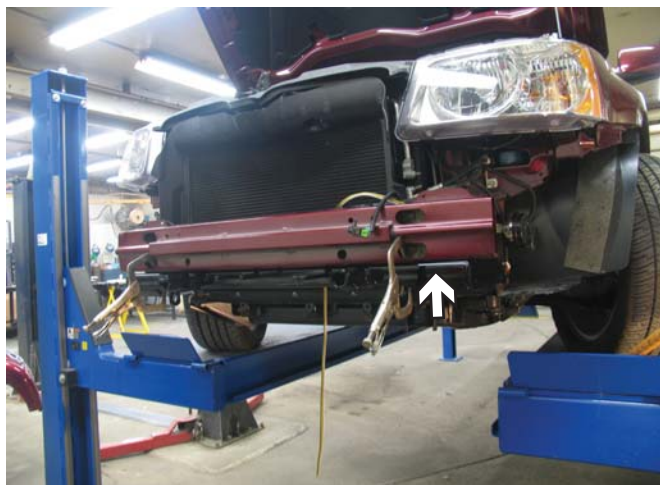

10. Slide the baseplate up, as far forward as possible and clamp to the bottom of the bumper.

BE SURE TO USE LOCTITE® RED ON ALL BOLTS BEFORE TIGHTENING. TIGHTEN ALL BOLTS ACCORDING TO THE TORQUE CHART ON THE FRONT PAGE OF THESE INSTRUCTIONS OR ON PAGE 3 OF THE BASEPLATE TOWING GENERAL INSTRUCTIONS.

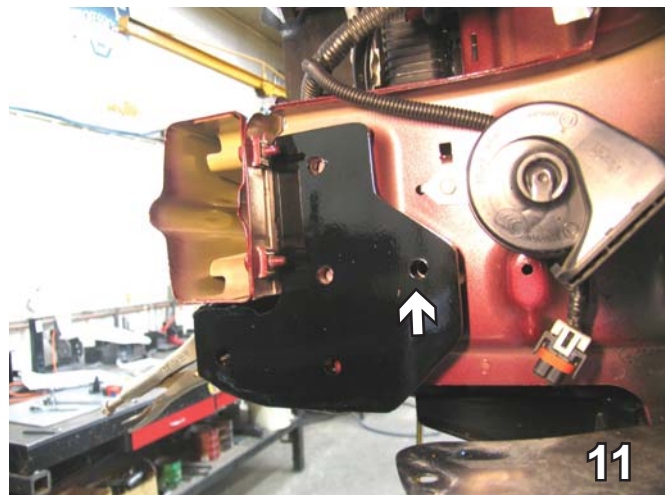

11. Using the baseplate as a template, with the 13/32" drill bit, drill one hole. Tighten with 3/8-16 x 2" bolt, 3/8" lock washer and 3/8-16 nut plate inserted into the frame. Use loctite. Do this on both sides. Drill the remaining holes.

BX3233
2008-09 Pontiac Torrent
Installation Instructions

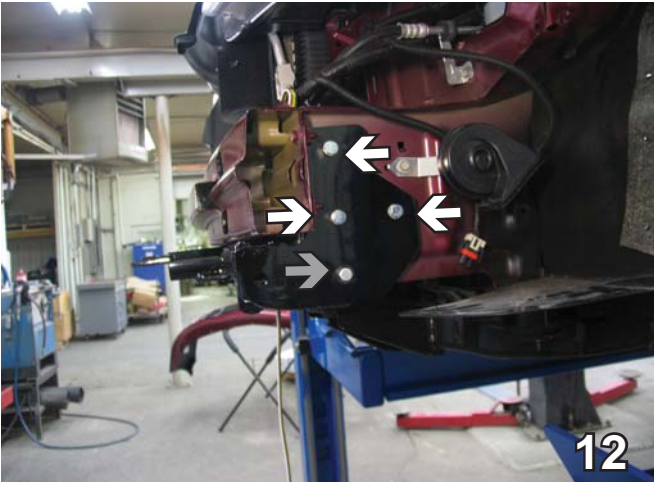

12. Insert into the top three holes (white arrows), 3/8-16 x 2" bolts with Loctite, 3/8" lock washers and attach to 3/8-16 nut plates inserted into the frame (figure 13A) and tighten. Insert into the bottom hole (gray arrow), 3/8-16 x 1 1/2" bolt with Loctite, 3/8" lock washer and attach to 3/8-16 nylon nut on the back (figure 13B). Do this on both sides.



13A. The opening in the frame into which the 3/8-16 nut plates are inserted for the top three holes.

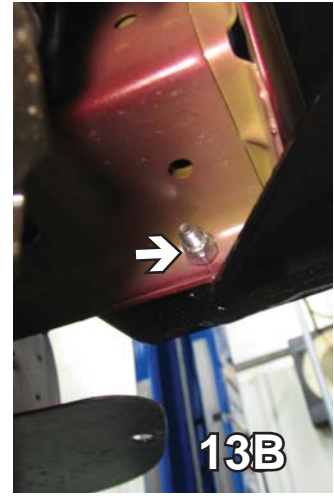

13B. The 3/8-16 nylon nut on the back side of the bottom hole.



14. Install the baseplate safety cables to the frame of the vehicle. If the vehicle has additional options which interfere with mounting the permanent baseplate safety cables, secure the cables to a solid piece of the vehicle frame as described in the instructions included with the permanent baseplate safety cables. Be sure the safety cables do not rub against any hoses or moving parts.



15. On the inside of the fascia, using the utility knife cut off the tab as shown. Do this on both sides.

Be sure that **ALL** electrical connections are plugged in properly and functioning **BEFORE** installing the fascia.

16. Reattach the black plastic guard. Two notches will need to be cut into it for the baseplate to fit in. Also reattach the fascia.

BX3233

2008-09 Pontiac Torrent

Installation Instructions

Install the tow bar and safety cables according to the instructions provided in their packages. When demonstrating this to the customer, be sure to include all the contents and packages.

Do **NOT** substitute other devices if the tow bar pins and clips are misplaced.

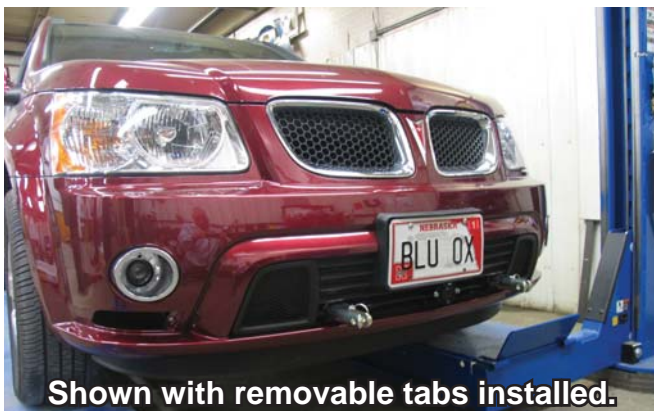

DEALER or INSTALLER:
Be certain the user receives the instruction sheets for their products.

CUSTOMER SERVICE COMMITMENT

Blue Ox is committed to providing you with exceptional customer care throughout your lifetime with our products. Our team is here to assist you with any questions you may have regarding the performance of your product. Simply call 1-800-228-9289 and you can speak with our customer care team.

Additionally, please visit our website to see which rallies our Destination America team will be attending. For a nominal fee, our service technician will service your towing system to ensure it's in proper working condition. Also as a commitment to our customers, should you visit our factory you can stay at our full service Blue Ox campground at no charge along with enjoying a factory tour.

Again thank you for being our customer and for the confidence you have shown in the performance of our products. It is because of customers like you we enjoy the success we have today.



© 2008, 09 Blue Ox
One Mill Road, Industrial Park
Pender, Nebraska 68047
Phone: (402) 385-3051 • Fax: (402) 385-3360
www.blueox.us