



Strong As An Ox™

## BX3754 Installation Instructions 2004 Toyota Scion XA

Serial No.

The headlight assembly, front fascia, horn bracket and windshield washer reservoir are removed for baseplate installation. Drilling is required. Trimming of air dam on metal bumper is required. The BX8869 is available for the vehicle. Attachment Tabs are 20 1/2 inches center to center and a height of 13 3/4 inches.



1. Remove the four push pins from the top edge of front grill.



2. Remove two metric bolts from top edge of fascia's tabs with the 10MM socket. Remove one push pin.



3. Just forward of front tire are two metric bolts, remove lower bolt with the 10MM socket, both sides.



4. Forward of front tires, on lower fascia's tabs, are eight metric bolts to remove with the 10MM socket.

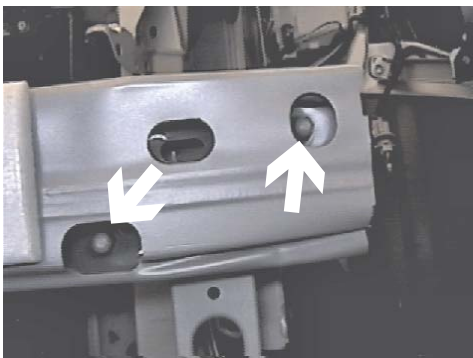

5. Using the 12MM socket, remove four metric nuts from metal bumper, pull metal bumper forward and set aside.

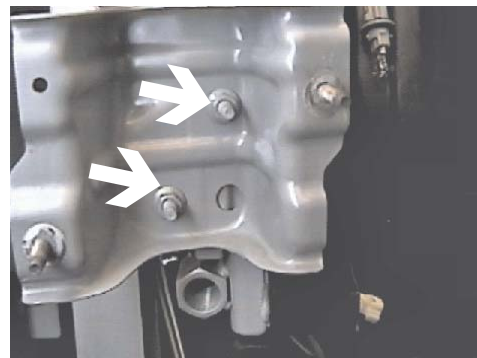

6. Remove two metric bolts from bumper bracket, both sides, pull forward and set aside.



Strong As An Ox™

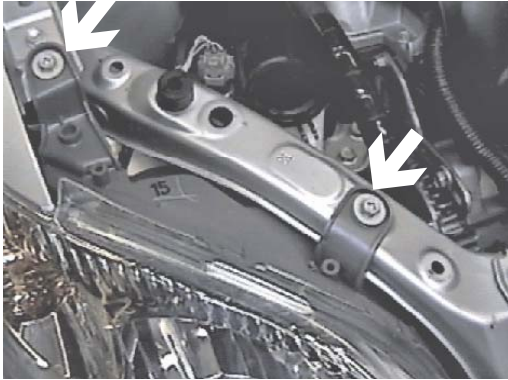

7. Remove four metric bolts from headlight assemblies, pull assembly forward, unplug electrical connection, both sides and set aside.

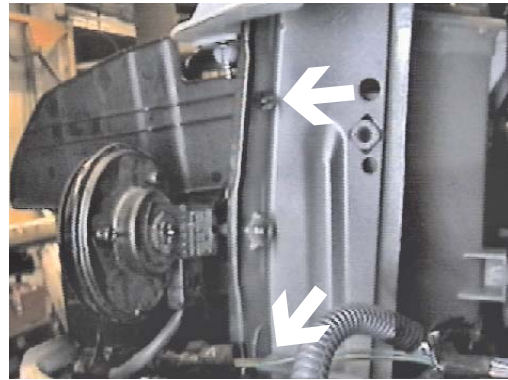

8. Pinch clips together on the back of radiator support and pull air dam forward, both sides and set aside.

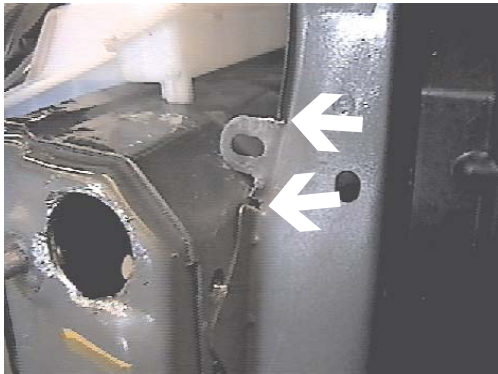

9. Make two short cuts in webbing using the hack saw, on radiator support and bend out of the way, both sides. Using the 1 1/4" hole saw, cut holes in frame ends, both sides. Some models may have a sensor on the driver's side webbing to relocate.



10. Remove top metric bolt from harmonic balancer on passenger's side, insert metric bolt into the three 1/4" flat washers and reinstall to original position.

11. Set baseplate on top of frame ends and clamp in place. Baseplate should be flat against the front of radiator support. Using the baseplate as a template, drill three holes with the 13/32" drill bit, both sides.

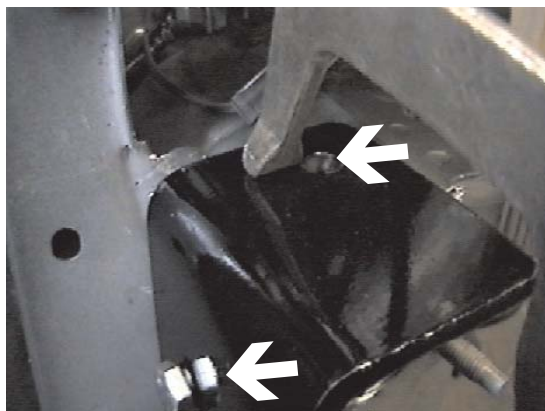



Strong As An Ox™

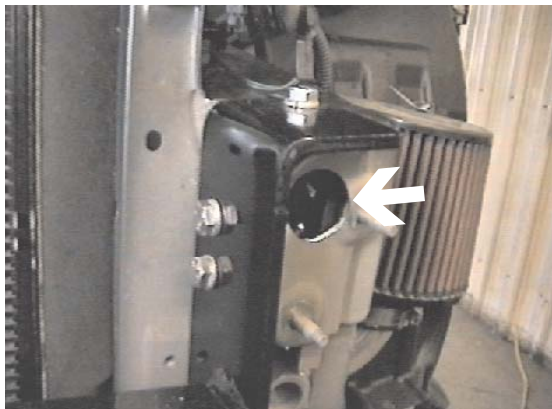

**12.** Insert 3/8" nut plate into frame end to align with drilled holes, tighten 3/8-16 x 1 1/2" bolt and lock washer with the 9/16" socket, both sides.  
**Be sure to use loctite on all bolts before tightening. Tighten all bolts according to Torque Chart in General Instruction Sheet.**

- 13.** Reinstall air dam (trim air dam as needed), bumper bracket, metal bumper, headlight assemblies and fascia. **Be sure all electrical components are plugged in properly.**
- 14.** The dimensional variations between otherwise identical cars can be considerable. While the location and size of the holes in the baseplate were designed to allow for easy installation, it may be necessary to file a hole slightly to allow a bolt to clear.
- 15.** Install the tow bar and safety cables according to the instructions included in their packages.
- 16.** Do **not** substitute other devices if the tow bar pin and clip are lost.
- 17. DEALER OR INSTALLER: BE CERTAIN THE USER RECEIVES THE INSTRUCTION SHEET.**

### Tools Required

10MM Socket  
Vise Grips  
Phillips Screw Driver

12MM Socket  
Loctite Red  
1 1/4" Hole Saw

9/16" Socket  
13/32" Drill Bit  
Hack Saw



Strong As An Ox™

### Parts List

Ref. No.	Qty.	Part No.	Description
1	1	61-5954	Weldment, Base Plate, BX3754
2	6	61-5208	3/8" Nut Plate, with Wire
3	6	201-0440	3/8-16 x 1 1/2 Bolt, Grd. 5, ZP
4	6	203-0010	3/8 Lock Washer, ZP
5	2	201-0553	1/4-20 x 1/2 Hx. Wshd, Type F Screw
6	2	201-0192	#10-32 x 1/2 Slot, Rd. Hd. Screw
7	2	203-0054	#10 Lock Washer
8	2	202-0047	#10-32 Hex Nut
9	2	101-5822	Adapter, 4 Way Connector
10	2	62-3468	Attachment, Assembly, SF/ SB (R)
	3	203-0001	1/4 Flat Washer (Not Shown)
	2	226-0046	Baseplate Safety Cable, 36" CL III (Not Shown)
	2	229-0359	Quicklink 3/8, ZP (Not Shown)
	2	290-0437	Receiver, Cap Plug (Blk) (Not Shown)

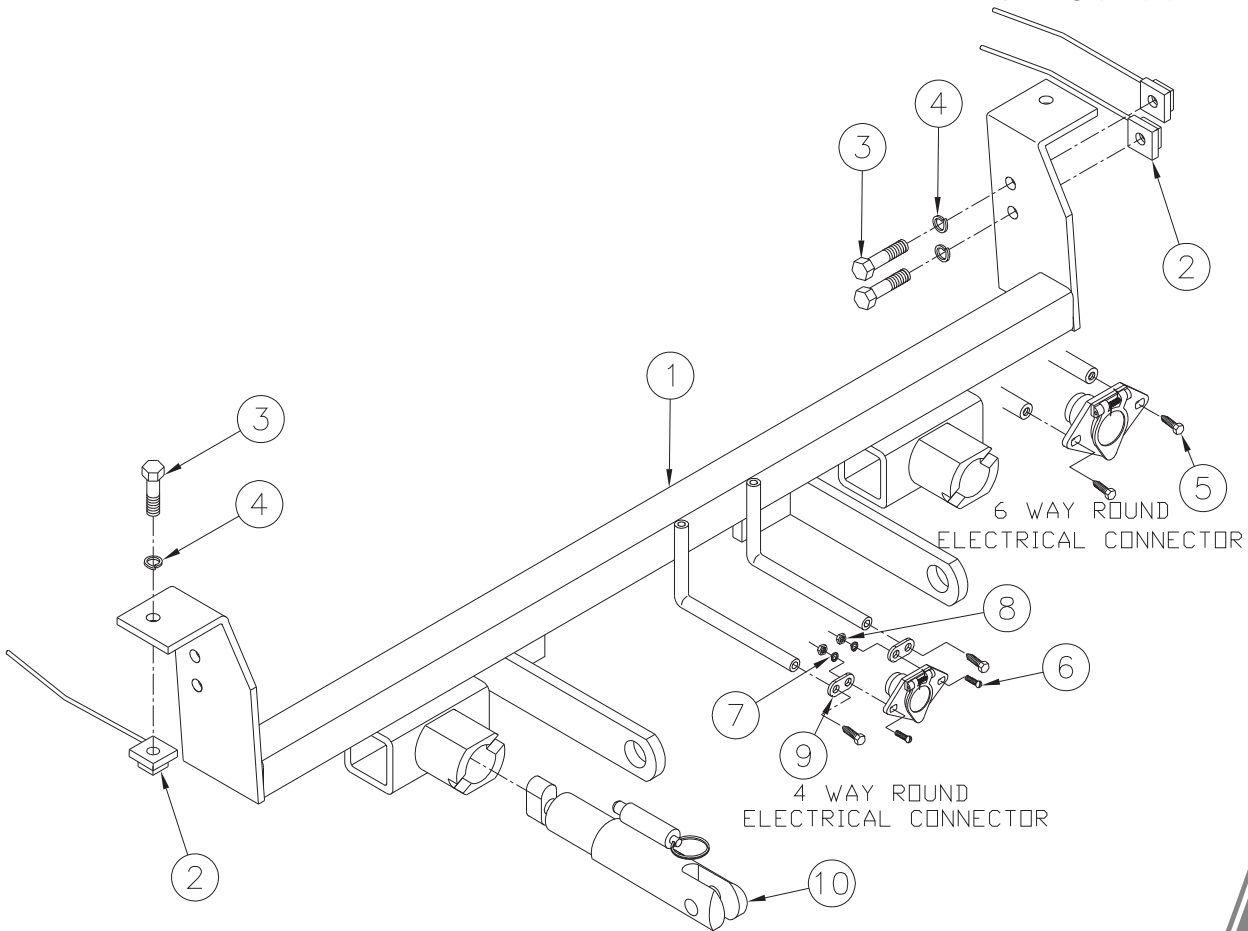

**IMPORTANT:** Use only genuine factory replacement parts on your Base Plate. Do not substitute homemade or nontypical parts. If a bolt is lost or in need of replacement, for your safety and the preservation of your Base Plate, be sure to use a replacement bolt of the same grade (Usually Grade 5, refer to parts list). Repair parts may be ordered through your nearest **Blue Ox** dealer or distributor.