



# BX3768

## 2007-14 Toyota FJ Cruiser Installation Instructions

Serial Number

Attachment Tab Height: 24-3/4"

Attachment Tab Width: 21"

**Please read BOTH these Installation Instructions and the General Instructions prior to installing or operating this equipment.**

- Blue Ox® towing products and accessories are intended to be installed by Blue Ox® Dealers who are familiar with our products and have the equipment and knowledge necessary to do "fit work". If needed, Blue Ox® Dealers can be found at [www.blueox.com](http://www.blueox.com) or by contacting our Customer Care Department at (402) 385-3051.
- Many Blue Ox® baseplates are designed to use existing holes and hardware to mount the baseplate to the towed vehicle. Even though bolts are there, do not assume they are adequate for baseplate mounting. Always use the hardware supplied in the hardware kit and existing hardware as specified in the installation instructions.

<b>Bolt Torque Specifications</b>		
Torque in Foot-Pounds for Inch Bolts		
Bolt Size	Grade 5	Grade 8
1/4"	10	14
5/16"	19	29
3/8"	33	47
7/16"	54	78
1/2"	78	119
5/8"	154	230
3/4"	257	380



<b>Bolt Torque Specifications</b>		
Torque in Foot-Pounds for Metric Bolts		
Bolt Size	Grade 8.8	Grade 10.9
6MM	6	8
8MM	16	22
10MM	31	40
12MM	54	70
14MM	89	117
16MM	161	230
18MM	222	318

If the front of your vehicle looks different than this, please contact us at (402)385-3051.

**Reference your vehicle owner's manual for manufacturer's towing specifications.**

## WARNING

Failure to read and follow these instructions could result in separation of the towed vehicle from the tow bar, causing property damage, loss of towed vehicle, personal injury or death.



# BX3768

## 2007-14 Toyota FJ Cruiser Installation Instructions

### Parts List

Ref. No.	Qty.	Part #	Description
1	1	61-6271	Weldment, Baseplate, BX3768
2	8	61-5208	3/8" Nut Plate, with Wire
3	2	101-6956	Support Plate, BX3758
4	4	201-0368	3/8-16 x 1 1/4" Bolt, Grd. 5, ZP
5	4	201-0440	3/8-16 x 1 1/2" Bolt, Grd. 5, ZP
6	8	203-0010	3/8" Lock Washer
7	2	201-0446	8mm-1.25 x 30mm, Hex Bolt, Grd. 8.8, ZP
8	2	203-0102	8mm Lock Washer, ZP
9	2	201-0603	12mm-1.25 x 45mm, Hex Bolt, Grd. 8.8, ZP
10	2	203-0105	12mm Lock Washer
11	6	203-0005	1/2" Flat Washer
12	6	203-0003	3/8" Flat Washer
13	2	201-0553	1/4-20 x 1/2" Hx. Wshd, Type F Screw
14	2	101-5822	Adapter, 4-Way Connector
15	2	201-0192	#10-32 x 1/2" Slot, Rd. Hd. Screw
16	2	203-0054	#10 Lock Washer
17	2	202-0047	#10-32 Hex Nut
18	2	62-3468	Attachment, Assembly, SF/LB (R)
19	2	290-0437	Receiver Cap, Plug (Not Shown)
20	2	226-0049	Permanent Baseplate Safety Cable (Not Shown)
21	2	229-0512	1/2" Quick Link (Not Shown)

### Tools Required

- Loctite® RED
- 10mm Socket
- 12mm Socket
- 14mm Socket
- 18mm Socket
- 9/16" Socket
- Phillips Screwdriver
- 13/32" Drill Bit
- 1 1/4" Hole Saw
- Utility Knife

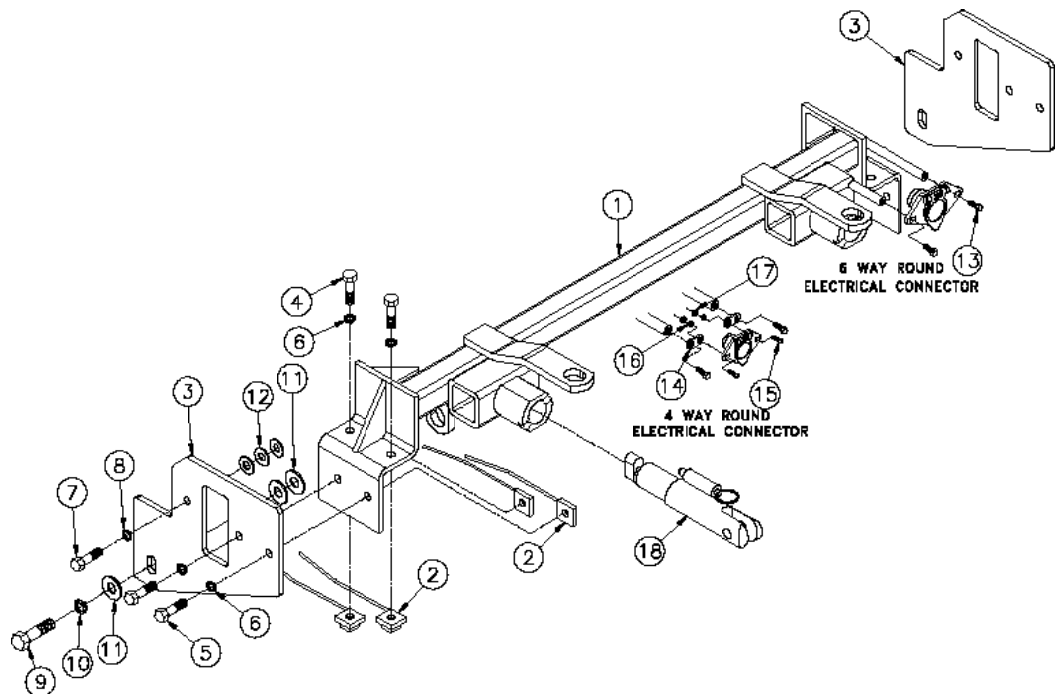

### Important:

Use only genuine factory replacement parts on your baseplate. Do **NOT** substitute homemade or non-typical parts. If a bolt is lost or in need of replacement, for your safety and the preservation of your baseplate, be sure to use a replacement bolt of the same grade (In most cases it will be Grade 5, please reference the parts list above). Replacement parts may be ordered through your nearest Blue Ox® Dealer or Distributor. Failing to follow and/or altering these installation instructions in either installation or required equipment will void the manufacturer's warranty.



# BX3768

## 2007-14 Toyota FJ Cruiser Installation Instructions

### Attachment Tabs:

Motorhome mount tow bars are recommended for use with this baseplate. Due to the design of the removable tabs, the RangeFinderII and Ambassador tow bars can not be used. Adapters, except the BX8833 and BX88151, can not be used with this baseplate.

**Installation Notes:** The fascia support crossbar, grille, belly pan, metal bumper and fascia are removed for installation. Drilling is required. The grille must be trimmed.

The dimensional variations between otherwise identical vehicles can be considerable. While the baseplate was designed for easy installation, it may be necessary to tailor the baseplate slightly to compensate for auto manufacturer's tolerances. These minor adjustments may include filing a hole slightly, bending electrical rods or bending end plates.

The BX8869 Bulb and Socket Wiring Kit is recommended for this vehicle.

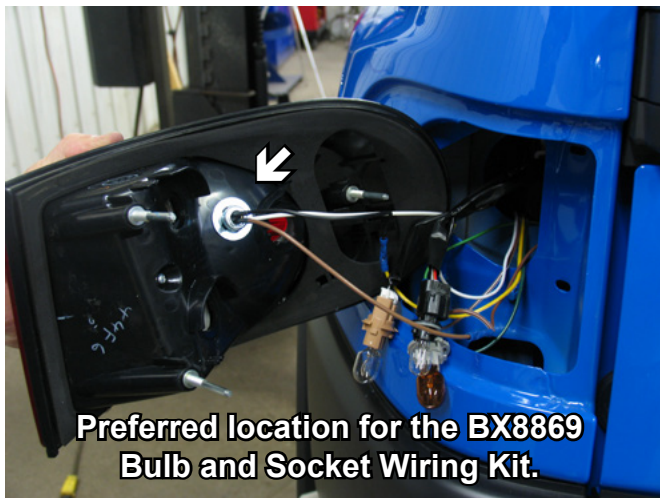

Preferred location for the BX8869 Bulb and Socket Wiring Kit.

Handling of some cosmetic parts when installing this product may require the use of protective covers, rags, specialty tools, etc. to prevent damage.

### Installation Instructions:

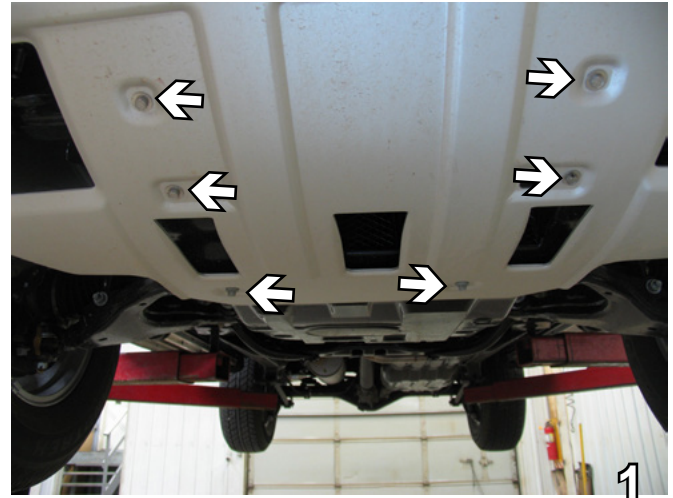

- 1. Using the 12mm socket, remove six metric bolts from the belly pan. Set belly pan and bolts aside to be reinstalled later.



- 2. Using a 10mm socket or Phillips screwdriver, remove the hex bolt from the grille support bracket (see white arrow). Remove the pushpin from the upper, outside edge of grille assembly (see grey arrow). Do this to both sides of the vehicle. Set bolts and pushpins aside to be reinstalled later.



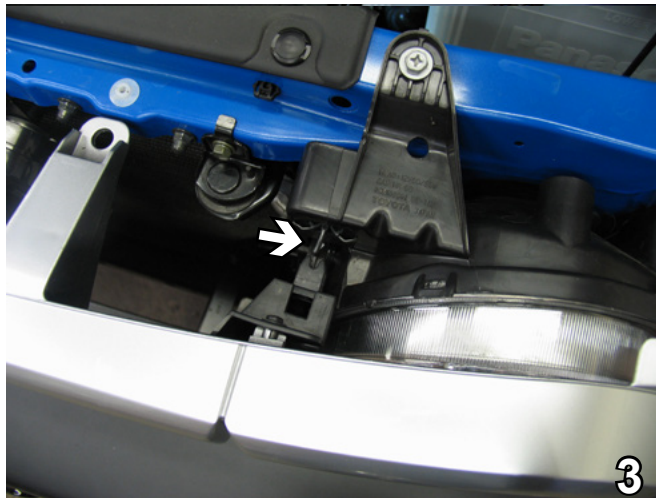

3. Just forward of the radiator, on the outside edge of the headlight assembly, press the tab in (see white arrow) and pull the grille slightly forward to release the upper clip. Do this to both sides of the vehicle. Pull grille forward to release the three lower grille clips. Set grille aside to be reinstalled later.



4. Remove three pushpins just behind the top edge of the bumper. Set pushpins aside to be reinstalled later.

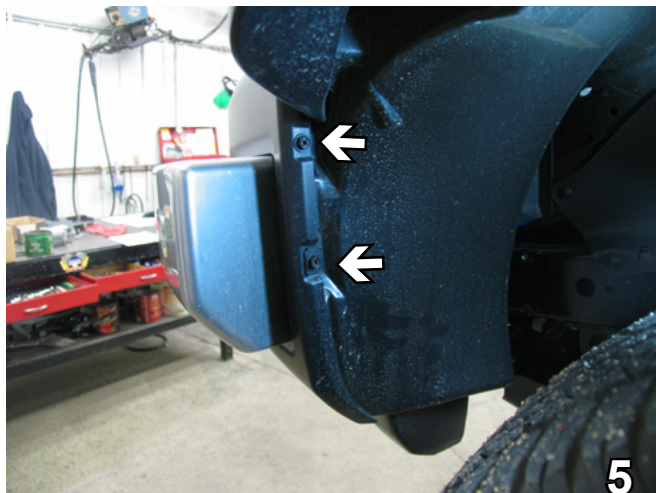

5. Using the 10mm socket, remove two metric bolts from the outside edge of wheel well, just forward of the front tire. Do this to both sides of the vehicle. Set bolts aside to be reinstalled later.



6. Using the 10mm socket, remove three metric bolts from the bottom corner of fascia, just forward of the front tire. Do this to both sides of the vehicle. Set bolts aside to be reinstalled later.

## BX3768

### 2007-14 Toyota FJ Cruiser Installation Instructions



7. Using the 10mm socket, remove two metric bolts from the bottom edge of the fascia, just forward of the radiator. Set bolts aside to be reinstalled later.



8. Grasp the top edge of the fascia's corner, just forward of the front tire and carefully push the fascia's corner towards the front tire, then pull to the side to release fascia. Do this to both sides of the vehicle. Pull fascia forward to remove. Set fascia aside carefully to be reinstalled later.

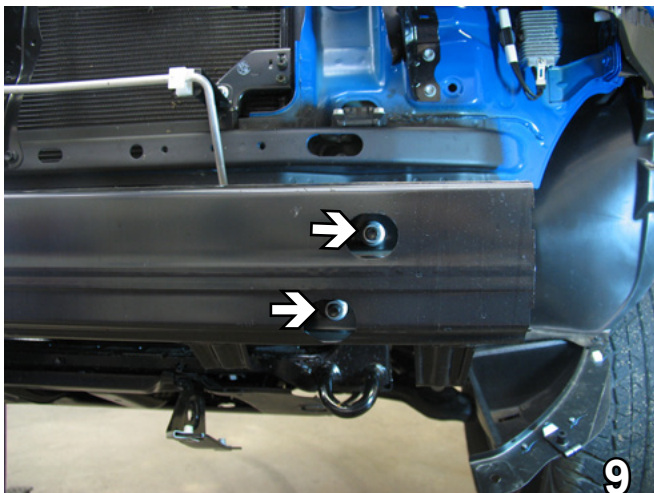

9. Using the 14mm socket, remove two metric bolts from the metal bumper. Do this to both sides of the vehicle. Pull metal bumper forward to remove. Set bolts and bumper aside to be reinstalled later.

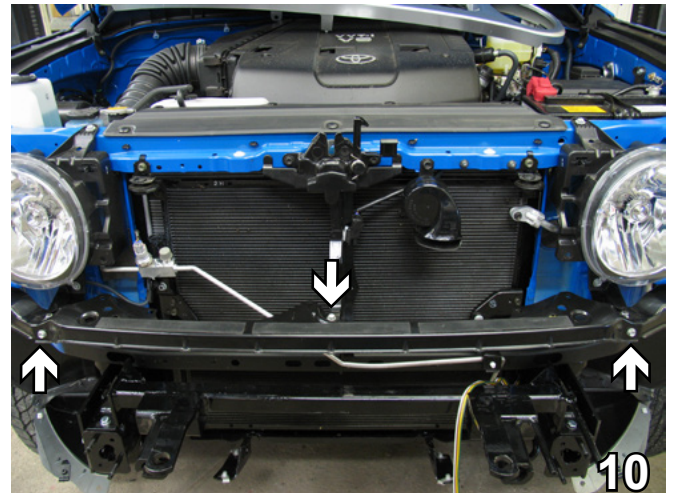

10. Using the 10mm socket, remove three bolts from the fascia support crossbar. Pull the crossbar forward to remove. Set bolts and crossbar aside to be reinstalled later.



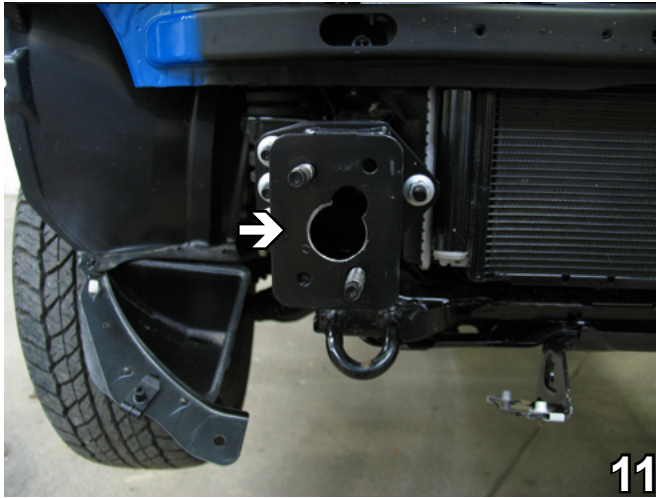

11. Using the 1 1/4" hole saw, drill out the center of the frame rail end plate. *Note: The cut should overlap the existing hole.* Do this to both sides of the vehicle.

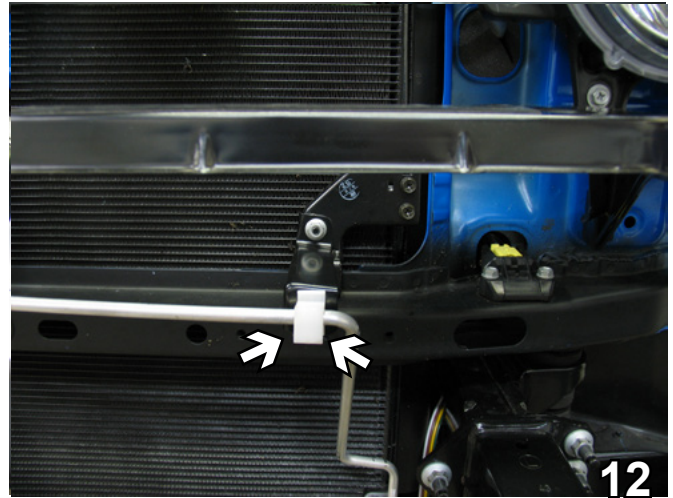

12. On the driver's side, squeeze the back side of the plastic retainer clip holding the coolant tubing. Pull retainer clip forward to release the coolant tubing from the bracket.



13. Slide the coolant tube behind the bracket. Rotate the retainer clip and insert into the back side of original bracket location to open the area for baseplate installation.

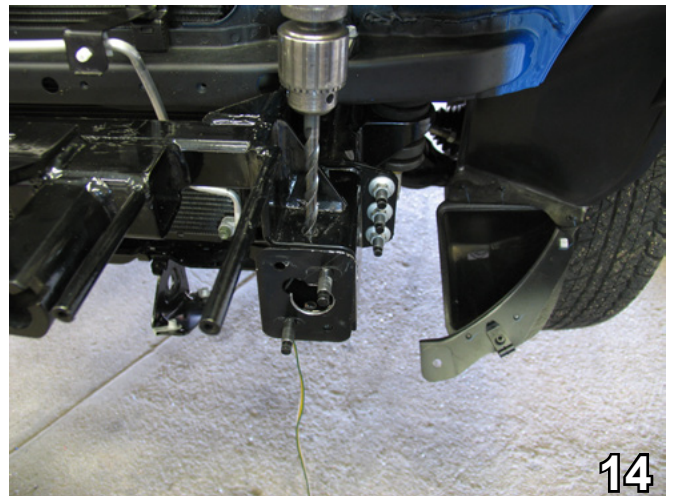

14. With the baseplate on top of the frame rail extension, use the baseplate as a template to drill two holes in the top of the extension with the 13/32" drill bit. Insert 3/8" nut plates into frame rail extension and align with drilled holes. Install 3/8-16 x 1 1/4" bolts and 3/8" lock washers to the baseplate and tighten to nut plates using the 9/16" socket. Trim nut plate wires. Do this to both sides of the vehicle.

**BE SURE TO USE LOCTITE® RED ON ALL BOLTS BEFORE TIGHTENING. TIGHTEN ALL BOLTS ACCORDING TO THE TORQUE CHART ON THE FRONT PAGE OF THESE INSTRUCTIONS OR ON PAGE 3 OF THE BASEPLATE TOWING GENERAL INSTRUCTIONS.**

**When using power drills be aware of the dangers of torque and drill bit length.**



# BX3768

## 2007-14 Toyota FJ Cruiser

### Installation Instructions

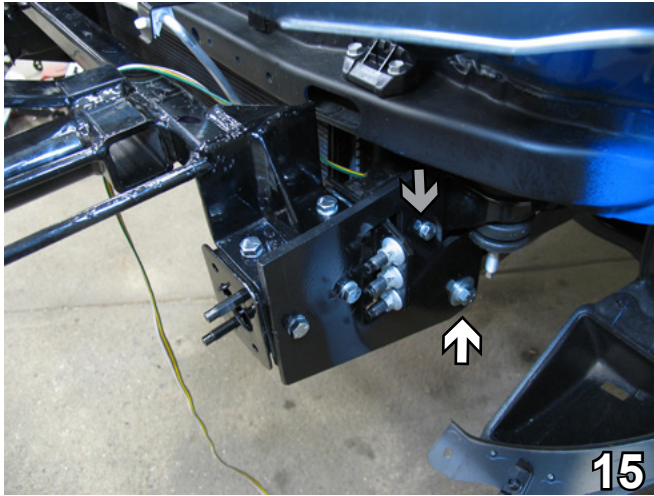

15. Align the support plate to the frame rail and baseplate so that the opening in the support plate is around the three frame extension bolts and the support plate slotted hole is aligned with the lower rear existing frame hole. Insert a 12mm - 1.25 x 45mm hex bolt, 12mm lock washer, and 1/2" flat washer into the slot (see white arrow). In the hole above the slot, insert a 8mm-1.25 x 30mm hex bolt, 8mm lock washer, and three 1/2" lock washers (see grey arrow). Finger-tighten only. Do this to both sides of the vehicle.

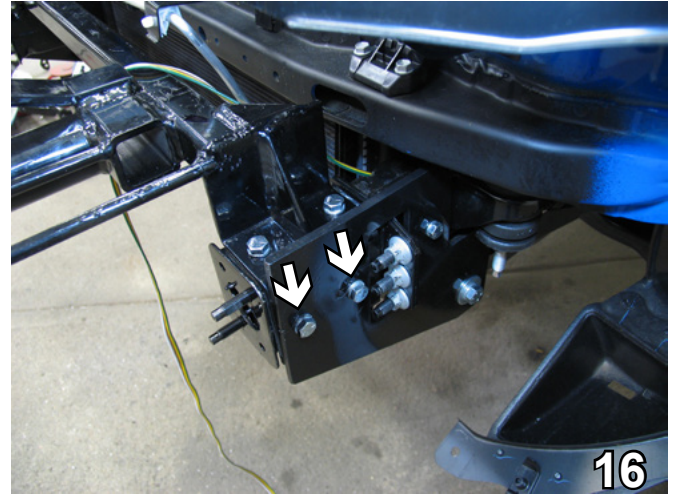

16. Align the front two holes of the support plate with the holes in the baseplate endplate. Using the support plate and baseplate endplates as templates, drill two holes in the frame extensions. Insert the 3/8" nut plates into the frame rail extension and align with the drilled holes. Install 3/8-16 x 1 1/2" bolts and 3/8" lock washers to the support plate and tighten to nut plates using the 9/16" socket. Trim the nut plate wires. Tighten the two rear bolts on the support plates using the 18mm socket for the lower bolt and the 13mm socket for the upper bolt.



17. Reinstall the belly pan, grille, metal bumper, and fascia support crossbar. Hold the fascia up to its original location. Mark and trim the grille with the utility knife as necessary for the attachment tabs, convenience links, and electrical rods. Reinstall the fascia.

**BE SURE TO USE LOCTITE® RED ON ALL BOLTS BEFORE TIGHTENING. TIGHTEN ALL BOLTS ACCORDING TO THE TORQUE CHART ON THE FRONT PAGE OF THESE INSTRUCTIONS OR ON PAGE 3 OF THE BASEPLATE TOWING GENERAL INSTRUCTIONS.**

**Be sure that ALL electrical connections are plugged in properly and functioning BEFORE installing the fascia.**





# BX3768

## 2007-14 Toyota FJ Cruiser

### Installation Instructions



18. Attach the permanent baseplate safety cables to the provided convenience link on the baseplate (see grey arrow). The photo above shows the recommended installation of the cables to frame of vehicle (see white arrow). Additional options may interfere with suggested mounting; in this case secure the cables to a solid piece of the frame as described in the instructions included with the permanent baseplate safety cables. Be sure the safety cables do not rub against any hoses or moving parts. Do this to both sides of the vehicle.

**DEALER or INSTALLER:**  
Be certain the user receives the instruction sheets for their products.

Install the tow bar and safety cables according to the instructions provided in their packages. When demonstrating this to the customer, be sure to include all the contents and packages.

Do **NOT** substitute other devices if the tow bar pins and clips are misplaced.

## Instructions for Optional BX8869 Bulb and Socket Wiring Kit

These instructions show how to gain access to the passenger's side tail light for vehicle's equipped with an optional subwoofer. Follow the instructions included with the BX8869 Bulb and Socket Wiring Kit to complete installation.

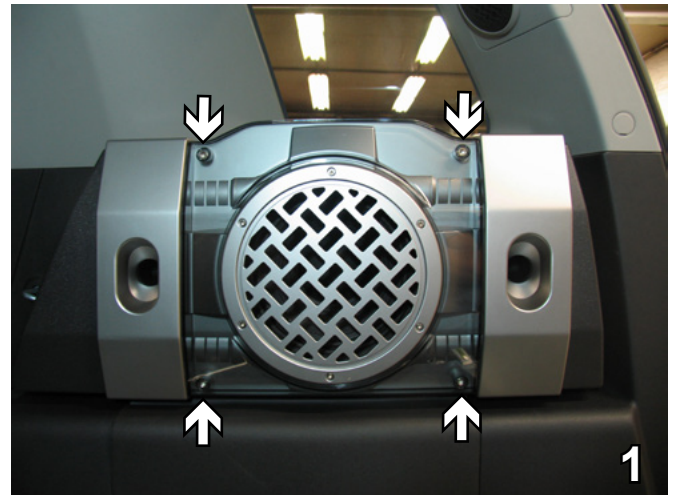

1. Use a 3/16" Allen wrench to remove four screws from the sub-woofer panel in the rear cargo area. Pull the panel forward to remove. Set panel aside to be reinstalled later.

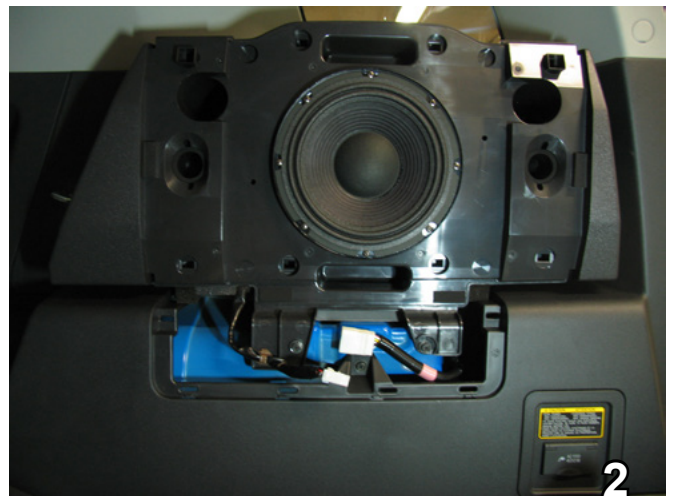

2. Use a flat screwdriver to pry upward on the panel below subwoofer to remove it. Or, pull forward on upper part of panel. Photo shows panel removed.



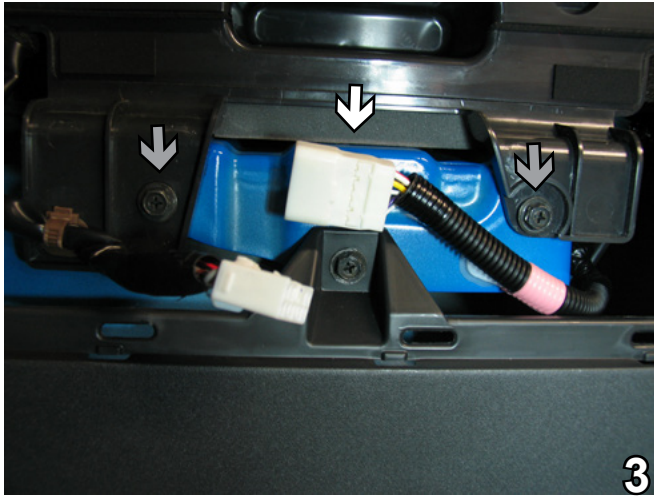

3. Disconnect the electrical connection (see white arrow). Remove two Phillips screws (see grey arrows). Set screws aside to be reinstalled later.



4. Remove one Phillips screw from each of the upper corners of the subwoofer case. Remove the subwoofer. Set screws and subwoofer aside to be reinstalled later.

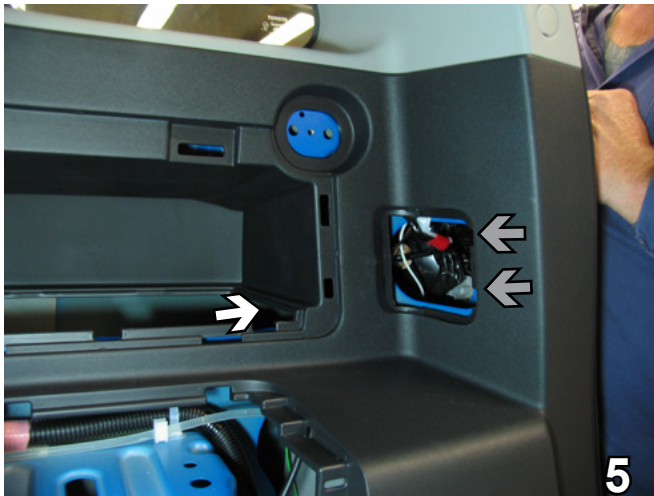

5. Using a flat screwdriver, pry off the taillight panel. In the subwoofer recess, (see white arrow) angle a 10mm deep socket upward to reach two metric bolts in taillight area (see grey arrows). Use a 10mm wrench on the other side of the metric bolts to remove them. Set all aside to be reinstalled later.

The passenger's side taillight can now be accessed. Continue installation by following the instructions included with the BX8869 Bulb and Socket Wiring Kit.



## BX3768 2007-14 Toyota FJ Cruiser Installation Instructions



**Shown without removable tabs installed.**



**Shown with removable tabs installed.**

If the baseplate is in an accident, it must be replaced. DO NOT use it again! An accident can cause unseen damage and using it again could result in more damage or serious injury. DO NOT use the baseplate if it is damaged or missing parts.

### CUSTOMER SERVICE COMMITMENT

Blue Ox is committed to providing you with exceptional customer care throughout your lifetime with our products. Our team is here to assist you with any questions you may have regarding the performance of your product. Simply call (402) 385-3051 and you can speak with our customer care team.

Additionally, please visit our website to see which rallies our Destination America team will be attending. For a nominal fee, our service technician will service your towing system to ensure it's in proper working condition. Also as a commitment to our customers, should you visit our factory you can stay at our full service Blue Ox campground at no charge along with enjoying a factory tour.

Again thank you for being our customer and for the confidence you have shown in the performance of our products. It is because of customers like you we enjoy the success we have today.



© 2006, 07, 10, 11 Blue Ox  
One Mill Road, Industrial Park  
Pender, Nebraska 68047  
Phone: (402) 385-3051 • Fax: (402) 385-3360  
[www.blueox.com](http://www.blueox.com)