



**BLUE OX®**

**BX3781**

2009-13 Toyota Corolla S/LE/XLE  
**Installation Instructions**

**Serial Number**

Please read BOTH these Installation Instructions and the General Towing Instructions before attempting to install or operate this equipment.

- Blue Ox® towing products and accessories are intended to be installed by Blue Ox® Dealers who are familiar with our products and have the equipment and knowledge to do “fit work.” When necessary, Blue Ox® Dealers can be found at [www.blueox.com](http://www.blueox.com) or by contacting our Customer Care Department at (800)228-9289.
- Many Blue Ox® Baseplates are designed to use existing holes and hardware to mount the baseplate to the towed vehicle. Even though bolts are there, do not assume they are adequate for baseplate mounting. Always use hardware supplied in the hardware kit or existing hardware specified in the Baseplate Towing Installation Instructions.

Attachment Tab Height: 15”  
Attachment Tab Width: 18 1/4”

**Bolt Torque Specifications**

Torque in Foot-Pounds per Metric Bolts

Bolt Size	Grade 8.8	Grade 10.9
6MM	6	8
8MM	16	22
10MM	31	40
12MM	54	70
14MM	89	117

Confirm the towability and pre-towing procedures for your vehicle with the owner’s manual or contact the vehicle’s manufacturer for specific towing procedures.

**Bolt Torque Specifications**

Torque in Foot-Pounds per Inch Bolts

Bolt Size	Grade 5	Grade 8
1/4”	10	14
5/16”	19	29
3/8”	33	47
7/16”	54	78
1/2”	78	119
5/8”	154	230



**! WARNING**

Failure to read and follow these instructions could result in separation of the towed vehicle from the tow bar, causing property damage, loss of towed vehicle, personal injury or death.



**BLUE OX®**

# BX3781

2009-13 Toyota Corolla S/LE/XLE

## Installation Instructions

### Parts List

Ref. No.	Qty.	Part #	Description
1	6	61-5208	3/8"-16 Nut Plate with 14" Wire
2	1	61-6550	BX3781 Baseplate
3	2	62-3469	Attachment Tab
4	2	101-5822	4 Way Connector Adapter
5	1	102-7204	Breakaway Bracket
6	2	201-0050	1/4"-20 x 3/4" Hex Head Bolt, Grade 5, ZP
7	2	201-0192	#10-32 x 1/2" Round Slotted Head Screw
8	6	201-0368	3/8"-16 x 1-1/4" Hex Head Bolt, Grade 5, ZP
9	2	201-0553	1/4"-20 x 1/2" Hex Wshd Type F TCS Screw, ZP
10	2	202-0047	#10-32 Hex Nut
11	2	202-0102	1/4"-20 Hex Nylon Nut, ZP
12	6	203-0010	3/8" Lock Washer, ZP
13	2	203-0054	#10 Lock Washer
14	2	226-0046 (not shown)	36" Class III Safety Cables
15	2	229-0359 (not shown)	3/8" Quicklink, ZP
16	1	290-0437 (not shown)	Black Receiver Cap Plug
17	1	293-1339 (not provided)	Breakaway Switch
18	1	294-0805 (not provided)	4 Pin Connector
19	1	294-0902 (not provided)	6 Pin Connector

### Tools Required

- |                  |                       |
|------------------|-----------------------|
| 10MM Socket      | Large Vise Grip       |
| 14MM Socket      | Flat Screw Driver     |
| 9/16" Socket     | Phillips Screw Driver |
| 1 1/4" Hole Saw  | Utility Knife         |
| 13/32" Drill Bit | Loctite Red           |

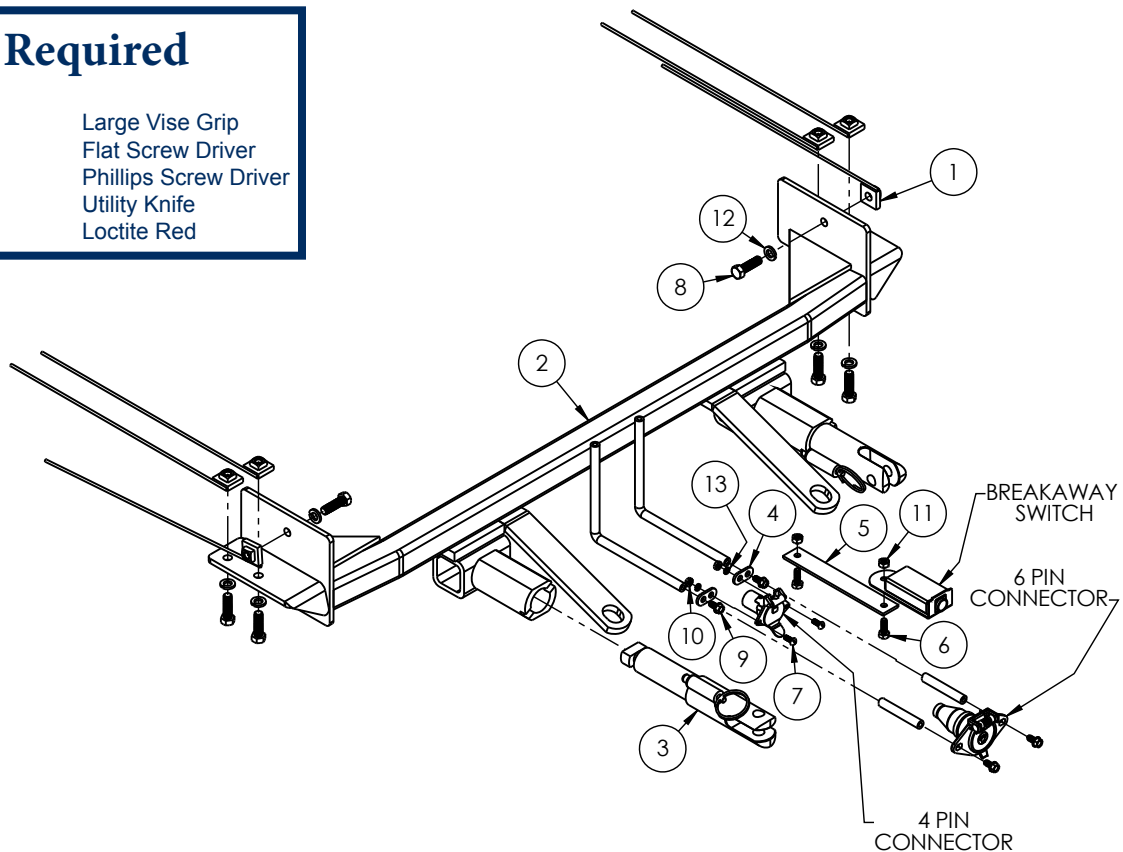

### Important:

Use only genuine factory replacement parts on your baseplate. Do **NOT** substitute homemade or non-typical parts. If a bolt is lost or in need of replacement, for your safety and the preservation of your baseplate, be sure to use a replacement bolt of the same grade (In most cases it will be Grade 5, please reference the parts list above). Replacement parts may be ordered through your nearest Blue Ox® Dealer or Distributor.



**BLUE OX**®

# BX3781

## 2009-13 Toyota Corolla S/LE/XLE Installation Instructions

### Vehicle Weight:

Motorhome mount tow bars are recommended for use with this baseplate. Due to the design of the removable tabs, the RangeFinderII, Adventurer, and Ambassador tow bars can not be used. The Acclaim tow bar may be used, but will not fold and store on the front of the vehicle. Adapters, except the BX8833 and BX88151, can not be used with this baseplate.

**Tow Bar Adapters are NOT to be used with vehicles weighing over 5,000 lbs.**

**Installation Notes:** The fascia and aluminum bumper are removed and reinstalled during installation of the baseplate. Drilling is required. Trimming of the fascia is required.

The dimensional variations between otherwise identical vehicles can be considerable. While the baseplate was designed for easy installation, it may be necessary to tailor the baseplate slightly to compensate for auto manufacturer's tolerances. These minor adjustments may include filing a hole slightly, bending electrical rods and/or bending end plates.

The BX8848 Bulb and Socket Wiring Kit is recommended for this vehicle.

### Installation Instructions:



1. Using the Phillips screw driver, remove the Phillips screws (white arrow) from the top corner edge of the fascia. Remove push pin (gray arrow), do this to both sides and set aside for later reinstallation.

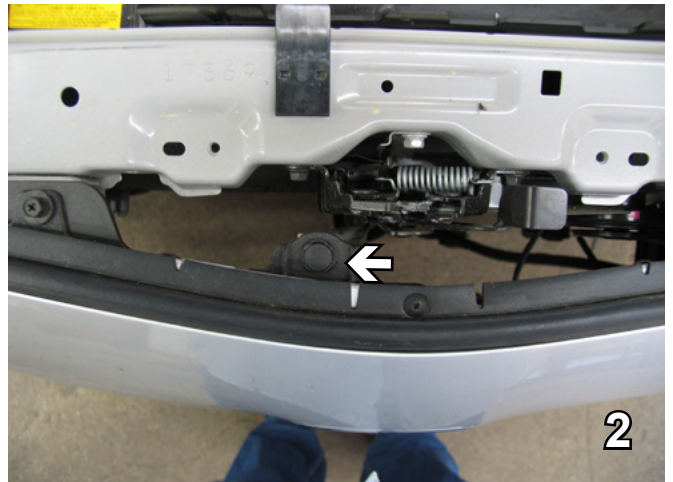

2. Remove push pin from top edge of fascia just below hood latch and set aside for reinstallation later.





**BLUE OX**

# BX3781

2009-13 Toyota Corolla S/LE/XLE

## Installation Instructions



3. Just forward the front tire on the upper corner of the fascia and inside the wheel well, turn the screw 90° to remove it (white arrow). Using a flat screw driver, remove the upper push pin (gray arrow). Do this on both sides and set aside for later reinstallation.

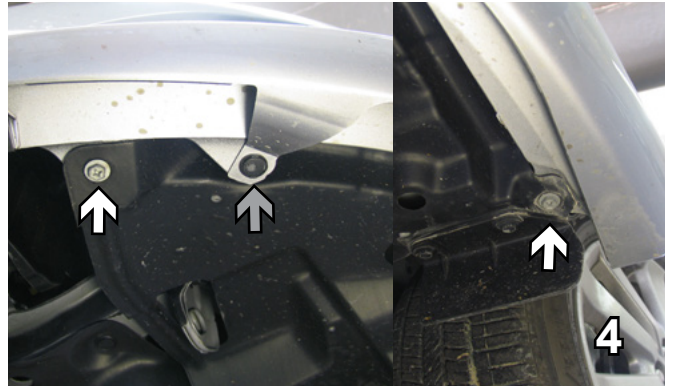

4. Just forward of the front tire underneath, using a 10MM socket, remove the two metric bolts (white arrows). Using a flat screw driver, remove the push pin (gray arrow). Do this on both sides and set aside for later reinstallation.



5. Behind the fascia on the bottom of the bumper, are two push pins to remove from the fascia's tabs. Remove with a flat screw driver. Pull the fascia forward on both sides and set aside for later reinstallation.

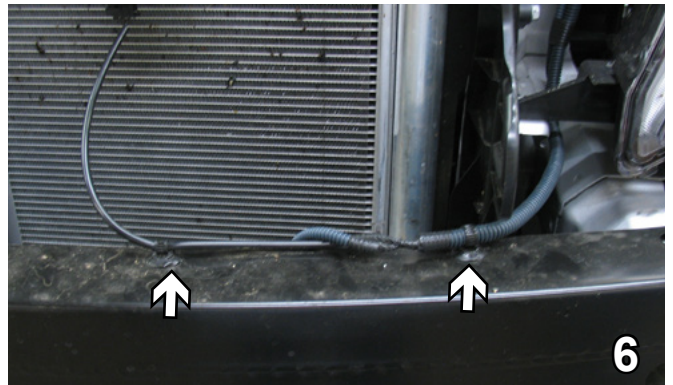

6. Remove the styrofoam. On the driver's side only, using a flat screw driver release the tabs from the top of the bumper and tie the wire loom up in the open area during baseplate installation.

7. Using a 14MM socket, remove the two bolts on each side of the bumper and take the bumper off. Set aside for later reinstallation.

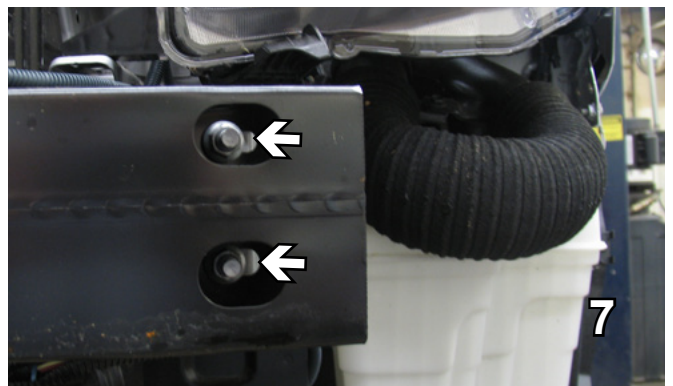



**BLUE OX®**

# BX3781

2009-13 Toyota Corolla S/LE/XLE

## Installation Instructions



8. Remove the black shield on both sides. It will not be reinstalled.

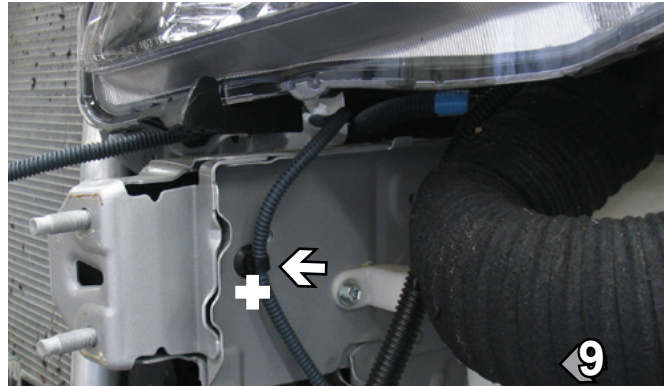

9. On the driver's side pull the wiring out of the existing hole. Drill a hole in the frame rail under but connected with the existing hole using the 1 1/4" hole saw on both sides. This hole will allow the installer to insert the nut plates inside of the frame rail.

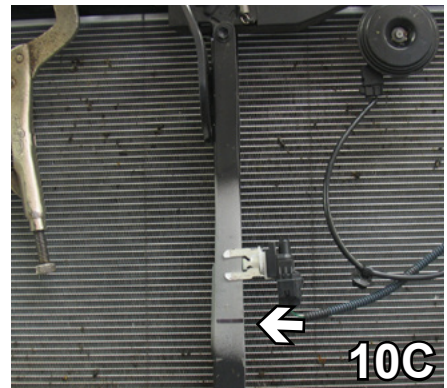
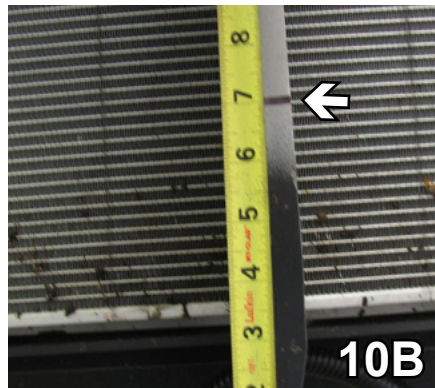
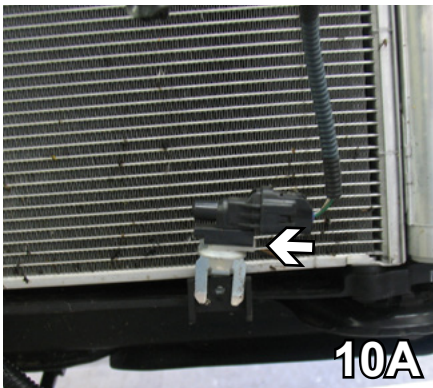

10. Move the bracket out of the way by sliding it up. Measure 7" up. Reroute the wire up and reattach the bracket so that the bottom of it is 7" up.

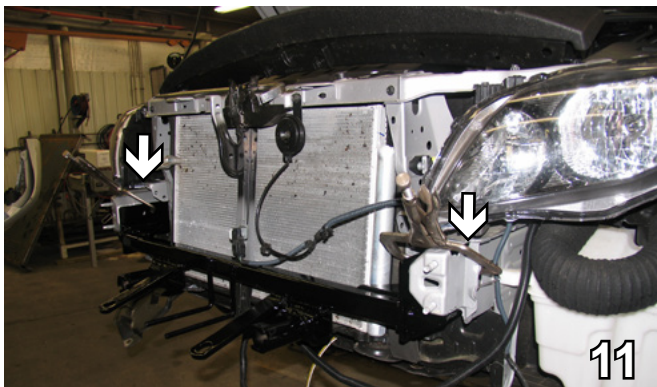

11. Slide the baseplate up between the frame rails, align with the existing hole on each side and clamp.





**BLUE OX**

# BX3781

2009-13 Toyota Corolla S/LE/XLE

## Installation Instructions

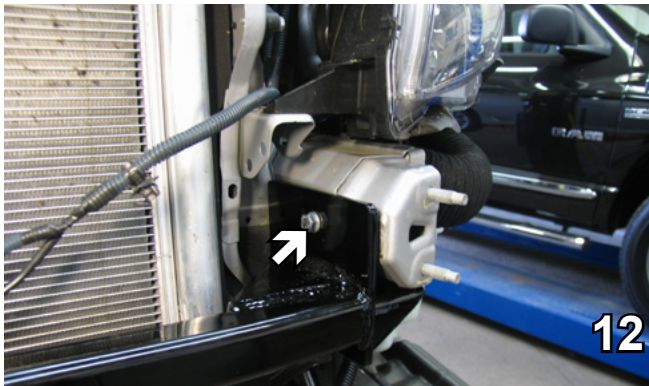

12. Insert 3/8-16 x 1 1/4" hex bolts with 3/8" lock washers attached to 3/8-16 nut plates with inserted into the frame rail on both sides to hold the baseplate in place.

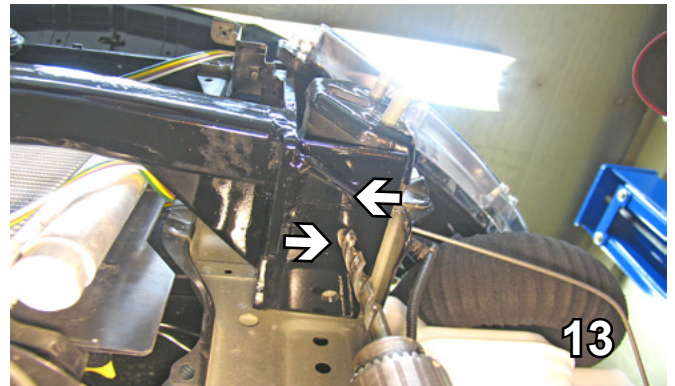

13. Using the baseplate as a template, drill both holes in the under side of the frame rail with a 13/32" drill bit. Do this on both sides.

**BE SURE TO USE LOCTITE® RED ON ALL BOLTS BEFORE TIGHTENING. TIGHTEN ALL BOLTS ACCORDING TO THE TORQUE CHART ON THE FRONT PAGE OF THESE INSTRUCTIONS OR ON PAGE 3 OF THE BASEPLATE TOWING GENERAL INSTRUCTIONS.**

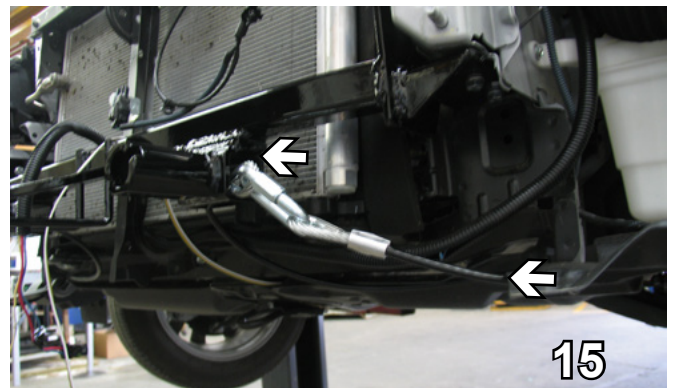

15. Attach baseplate safety cables as in above photos or as close to as possible. If you are unable to place safety cables in this location, position the cables around a solid piece of the frame. Do this on both sides.

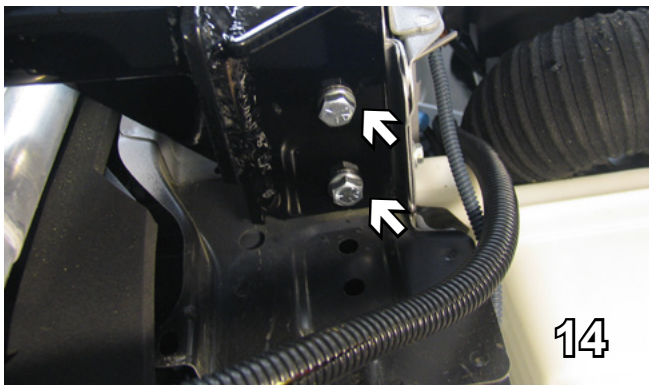

14. Insert 3/8-16 x 1 1/4" hex bolts and 3/8" lock washers with 3/8-16 nut plates with inserted into the frame rail. Use loctite on all the bolts and tighten. Do this on both sides and the bolts inserted previously. Reinstall the bumper.

Install the tow bar and safety cables according to the instructions provided in their packages. When demonstrating this to the customer, be sure to include all the contents and packages.

Do **NOT** substitute other devices if the tow bar pins and clips are misplaced.



**BLUE OX®**

# BX3781

2009-13 Toyota Corolla S/LE/XLE

## Installation Instructions

**DEALER or INSTALLER:**  
Be certain the user receives the instruction sheets for their products.

Be sure that **ALL** electrical connections are plugged in properly and functioning **BEFORE** installing the fascia.

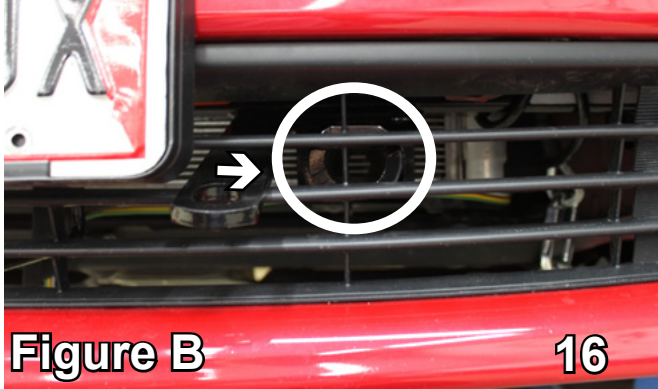

16. Hold the fascia as close to its original position as possible, mark and trim the grill with a utility knife to allow the baseplate receivers to come through. Reinstall the fascia.

**NOTE:** On 2009-10 models see Figure A. For 2011 models reference Figure B.

### CUSTOMER SERVICE COMMITMENT

Blue Ox is committed to providing you with exceptional customer care throughout your lifetime with our products. Our team is here to assist you with any questions you may have regarding the performance of your product. Simply call 1-800-228-9289 and you can speak with our customer care team.

Additionally, please visit our website to see which rallies our Destination America team will be attending. For a nominal fee, our service technician will service your towing system to ensure it's in proper working condition. Also as a commitment to our customers, should you visit our factory you can stay at our full service Blue Ox campground at no charge along with enjoying a factory tour.

Again thank you for being our customer and for the confidence you have shown in the performance of our products. It is because of customers like you we enjoy the success we have today.



© 2008, 09, 12 Blue Ox  
One Mill Road, Industrial Park  
Pender, Nebraska 68047

Phone: (402) 385-3051 • Fax: (402) 385-3360

www.blueox.com

3/1/12