

INSTALLATION INSTRUCTIONS

2007-16 JEEP WRANGLER
PART# P1050

PARTS LIST:

Qty	Description	Qty	Description
1	Grille Guard	18	12mm x 24mm OD x 2.5mm Flat Washers
1	Driver/Left Frame Mounting Bracket	10	12-1.75mm Nylon Lock Nuts
1	Passenger/Right Frame Mounting Bracket	2	10-1.5mm x 30mm Button Head Bolts
1	Driver/Left Top Mounting Bracket	4	10mm x 20mm OD x 2mm Flat Washers
1	Passenger/Right Top Mounting Bracket	2	10mm Nylon Lock Nuts
2	8mm Special Rod Bolts	2	8mm x 28mm OD x 3mm Large Flat Washers
8	12-1.75mm x 30mm Hex Bolts	2	8mm Nylon Lock Nuts
2	8mm Clip nuts	2	8mm Button head bolts
2	8mm Flat washers	2	8mm lock washers
1	Support flange	2	12mm x 35mm Bolt Plates
2	12mm Plastic Retainers		

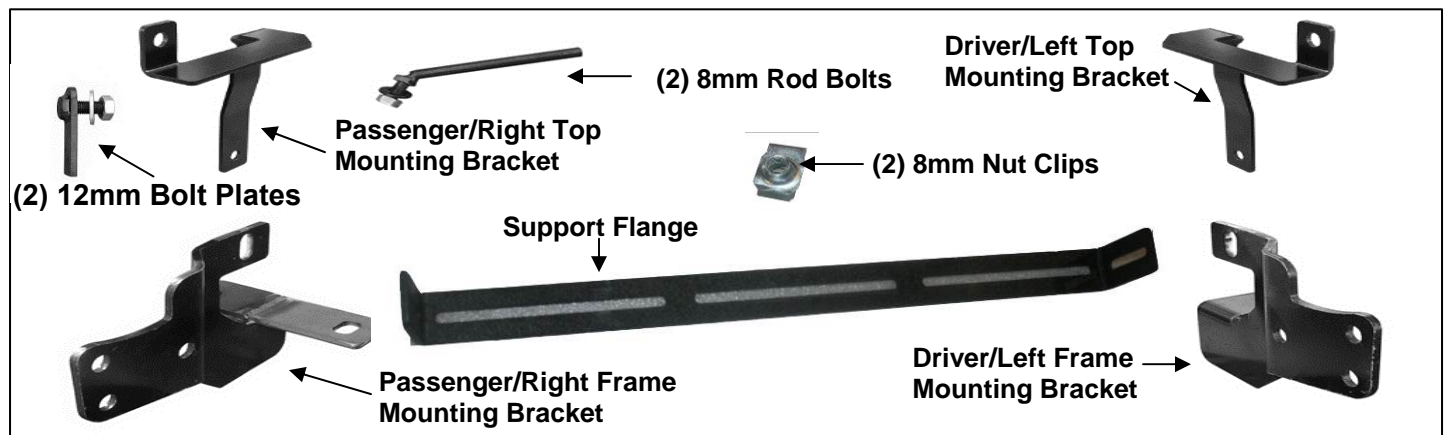

PROCEDURE:

1. REMOVE CONTENTS FROM BOX. VERIFY ALL PARTS ARE PRESENT. READ INSTRUCTIONS CAREFULLY BEFORE STARTING INSTALLATION. CUTTING IS REQUIRED. ASSISTANCE IS RECOMMENDED.
2. Starting under the front bumper of the vehicle, remove the plastic top fill plate between the bumper and the radiator. Also remove the lower factory splash guard. Place both on a clean, stable work surface.
3. Select the passenger side Frame Mounting Bracket. Bolt the Frame Mounting Bracket to the bottom of the cross member with (1) 12mm x 30mm Hex Bolt, (2) 12mm Flat Washers and (1) 12mm Nylon Lock Nut. **NOTE: 07-09 models** will use the outer mounting location (**Fig 1A**), and **2010-16 models** will use the inner mounting location, (**Fig 1B**). Insert (1) 12mm x 35mm Bolt Plate, (2) 12mm Flat Washers and (1) 12mm Nylon Lock Nut through the upper tab on the side of the Mounting Bracket upright and tighten hardware at this time, (**Fig 2**). Repeat this step to install the driver side Frame Bracket, (**Fig 1C**). *Figures 11 and 12 are the photos showing this step.*
4. Next, place the top fill plate back in position and mark a slot on the underside straight up from the frame upright, (the top brackets slide into the frame upright-see **Fig 5**). Cut (2) slots to clear the Top Brackets, (**Fig 3**). **NOTE:** Only cut a slot large enough to clear the Top Mounting Brackets.

IMPORTANT! Do not cut completely through front or rear edge of the fill panel. Reinstall the fill panel with the factory hardware.

5. Next, slide the driver side Top Bracket down through the slot in the fill panel and into the frame upright, **(Fig 4)**. Select (1) 8mm Rod Bolt. Insert the Rod Bolt into the opening at the base of the frame upright. Feed the Rod Bolt through the hole in the Top Bracket and out the frame upright above the tab on the Frame Bracket, **(Fig 5)**. Secure the Rod Bolt to the Top Mounting Bracket with the included (1) 8mm Flat Washer and (1) 8mm Nylon Lock Nut, **(Fig 6)**. Do not tighten hardware at this time. **NOTE:** On 2012-13 vehicles, move the factory valve out of the way to access the 8mm hardware on the driver side of the vehicle only. It is not necessary to remove or disconnect the valve, **(Fig 4, 6, 9)**.
6. Repeat Step 5 for the passenger side Top Mounting Bracket installation.
7. Hold the plastic lower splash guard up in its original position. Mark the location of the Mounting Brackets onto the inside of the splash guard, **(Fig 7)**. Cut out the sections to clear the Mounting Brackets. Check for clearance, trim as required and reinstall using the factory hardware. **IMPORTANT:** To maintain strength, remove as little material from the plastic splash guard as possible. Do not cut completely through the front or rear edge of the splash guard.
8. Select an LED light, mounting hardware and brackets (sold separately). Attach the hardware to the support flange. **Note:** LED manufactures may have different mounting styles or brackets. Once the mounting option is determined, attach it to the support flange.
9. With the LED light attached to the support flange, place a clip-nut on both ends of the support flange. Insert an 8mm hex bolt, lock washer and flat washer into the clip-nut. Leave enough space between the flat washer and clip-nut to slot the support flange into the light bar cage on the grille guard.
10. Place the grille guard face down on a flat, stable work surface. Insert the support flange into the light bar cage on the grille guard and ensure the flat washer, lock washer and head of the hex bolt are on the outside of the center flange.
11. With assistance, lift the Grille Guard up to the inside of the Frame Mounting Brackets. Line up the holes in the Frame Mounting Brackets with the holes in the Grille Guard. Insert (6) 12-1.75mm x 30mm Hex Bolts, (12) 12mm Flat Washers and (6) 12mm Nylon Lock Nuts, **(Fig 11)**. Push the grille guard back into an upright position. Secure the Top Brackets to the grille guard with the included (2) 10mm x 30mm Button Head Allen Bolts, (4) 10mm Flat Washers and (2) 10mm Nylon Lock Nuts, **(Fig 12)**. Adjust the Brackets as necessary then snug but do not tighten all of the hardware.
12. Stand back from the vehicle and check to see that the Grille Guard is centered and level on the vehicle and adjust as required. It may be necessary to slightly loosen the Frame mounting brackets to properly align the Grille Guard. **IMPORTANT:** Once properly aligned, tighten all of the hardware.
13. With the grill guard now attached you may begin to align your LED light up or down once aligned tighten the 8mm button head bolts on either side of the upright plates of the grill guard.
14. Now you may run your power wires for your LED light, Refer to the LED manufactures recommendations on the installing of LED wiring harness.

15. Do periodic inspections of the installation to make sure that all hardware is secure and tight.

To protect your investment, wax this product after installing. Regular waxing is recommended to add a protective layer over the finish. Do not use any type of polish or wax that may contain abrasives that could damage the finish.

For stainless steel: Aluminum polish may be used to polish small scratches and scuffs on the finish. Mild soap may be used also to clean the Grille Guard.

For gloss black finishes: Mild soap may be used to clean the Grille Guard.

Passenger Side Installation Pictured

12mm x 30mm Hex bolt
(2) 12mm Flat Washers
12mm Nylon Lock Nut

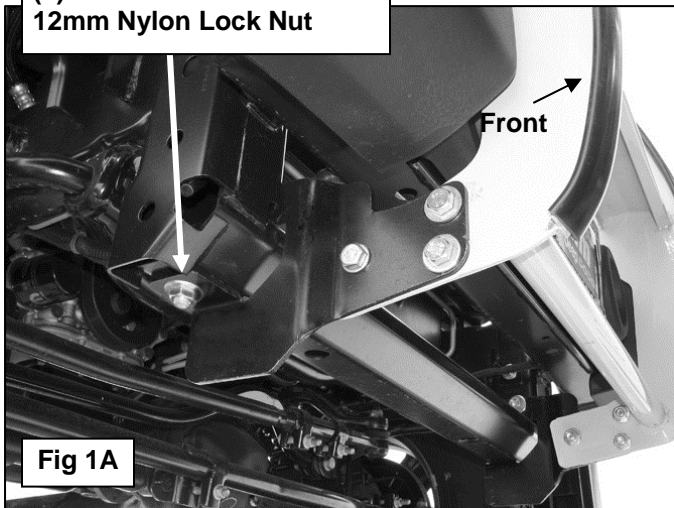

Fig 1A

07-09 Passenger side Frame Mounting Bracket bolts to the outer mounting location (pictured with Grille Guard in position for example only)

12mm x 30mm Hex bolt
(2) 12mm Flat Washers
12mm Nylon Lock Nut

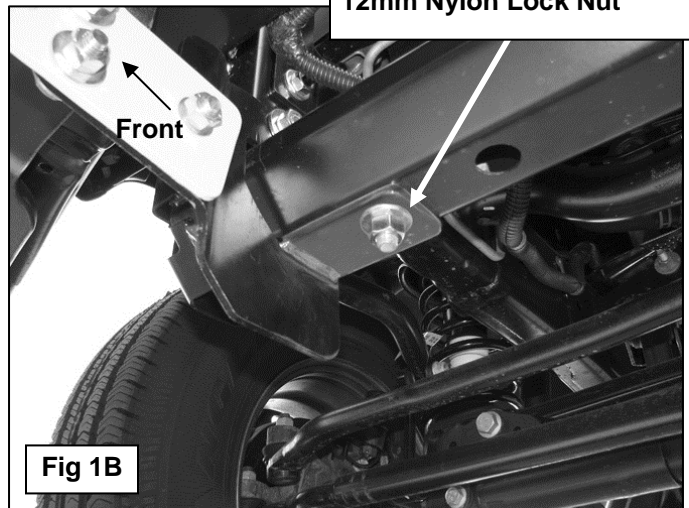

Fig 1B

2010-13 Passenger side Frame Mounting Bracket bolts to the inner mounting location (pictured with Grille Guard in position for example only)

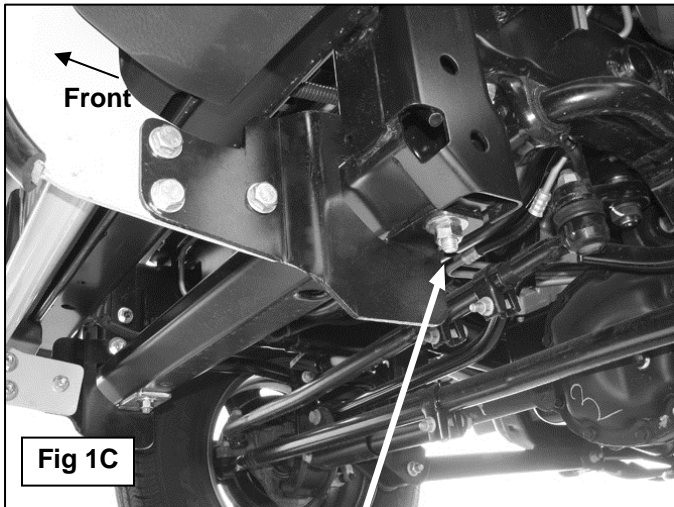
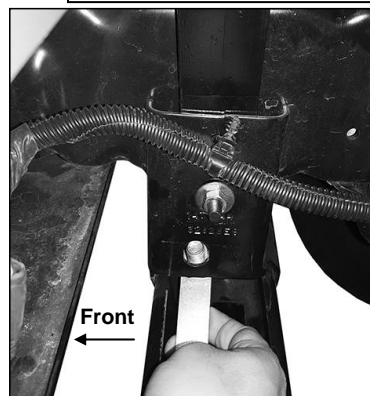

Fig 1C

2007-13 Driver side Frame Mounting Bracket installation (pictured with Grille Guard in position for example only)



(Fig 11) Passenger/right Bolt Plate installation below Top Bracket

Took these images from 1050/-2 INS

Use Plastic Retainer to hold Bolt Plate in place

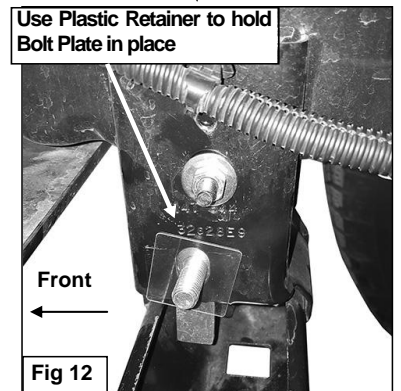
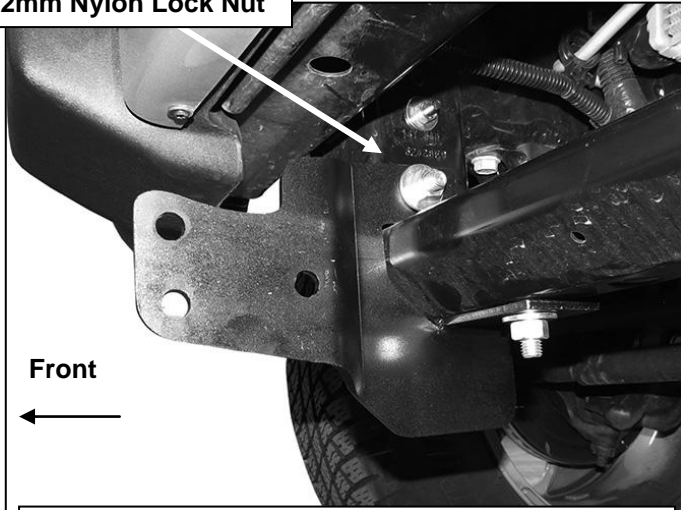

Fig 12

Driver Side Installation Pictured

12mm Flat Washer
12mm Nylon Lock Nut



(Fig 13) 2010-16 Passenger side Frame Mounting Bracket bolts to the inner mounting location.

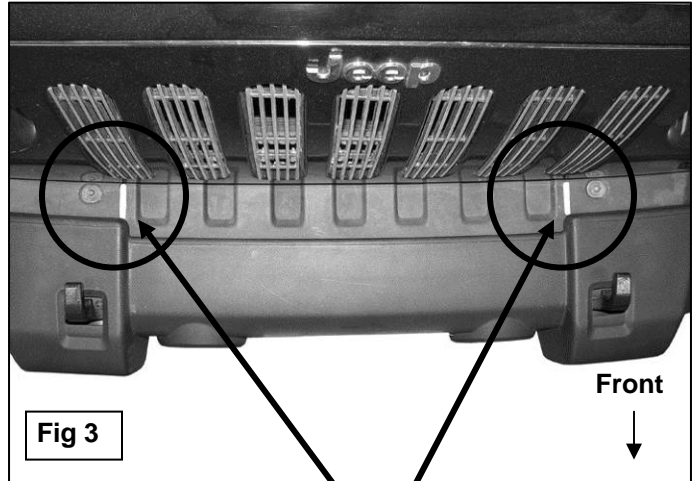
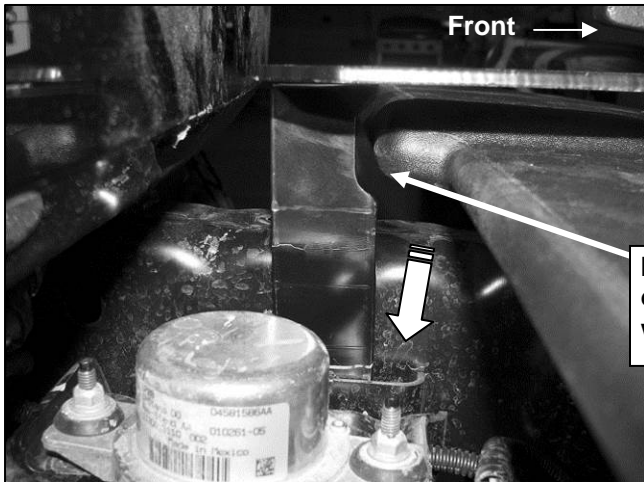

Fig 3

Reinstall the fill panel and mark the cut area on the bottom of the panel straight up from the frame upright. Start with a small opening and slowly enlarge the opening to get the best fit around the brackets. Area cut from fill panel pictured for example only.



Insert Bracket into the opening and bolt in place with special Rod Bolt

(Fig 4) Pictured without fill plate for example only

8mm Flat Washer
8mm Nylon Lock Nut

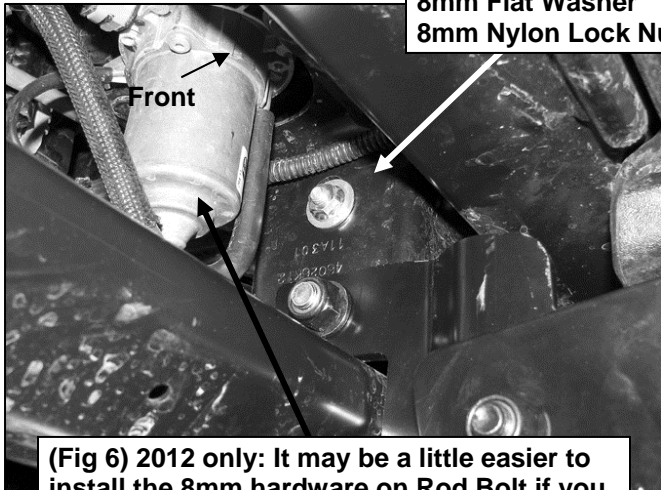

(Fig 6) 2012 only: It may be a little easier to install the 8mm hardware on Rod Bolt if you temporarily move this factory valve out of the way-do not remove or disconnect

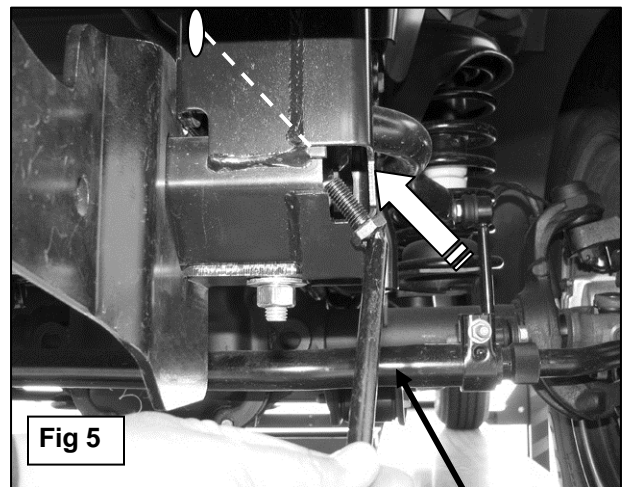

Fig 5

Insert (1) 8mm Rod Bolt up through opening in corner, hole in Top Bracket and out hole in side of frame upright

Driver Side Installation Pictured



Once the Mounting Brackets have been installed and checked for alignment, hold the splash guard up into position and mark the cut area on the inside of the guard. Start with a small opening and slowly enlarge the opening to get the best fit around the brackets. Area cut from guard pictured for example only. (Interior view)

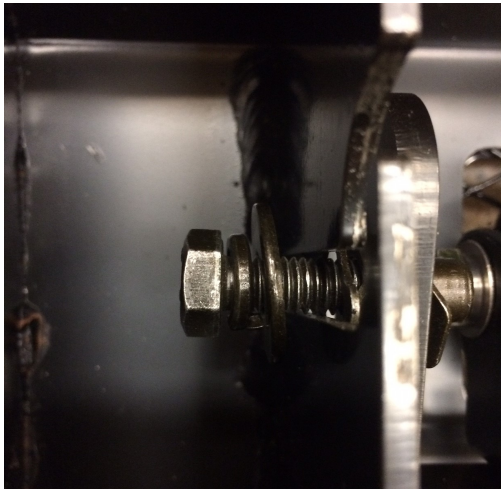

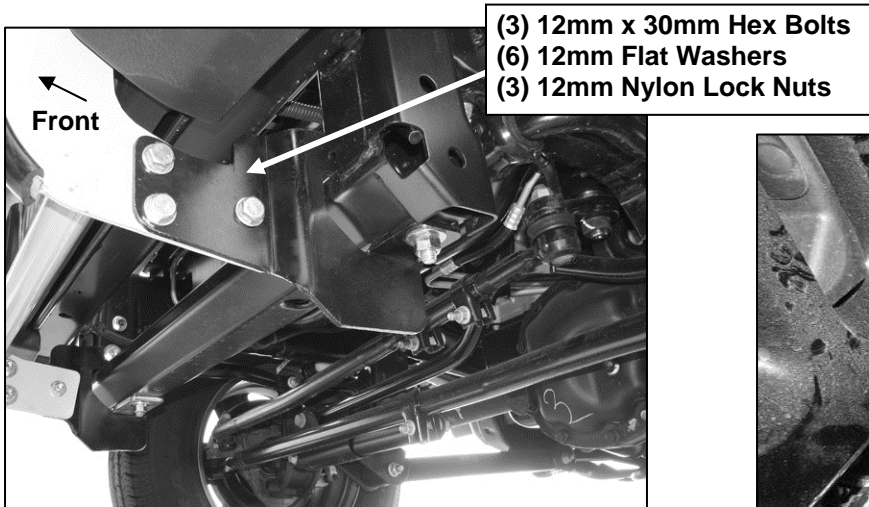

(Fig 11) Pictured without splash guard for example

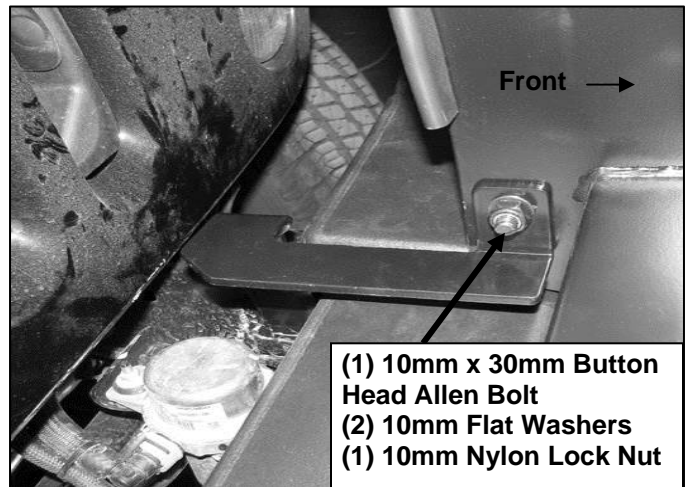

(Fig 12) Pictured without fill plate for example

